

metalco SOCIAL  
DESIGN  
FOR  
REAL LIFE

STILE  
THE FEATURES

METALCO is part of THE PLACEMAKERS



STILE  
THE FEATURES



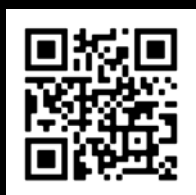

This catalogue is dedicated to all professionals who aim to create places and with whom we want to design our cities' present and future.

What you are going to find in *STILE* is the result of the hard work of our team and invaluable collaborations with architects, designers, and urban planners with whom we share ideals and passions.

Our vision: realizing sustainable urbanization through *Social Design for Real Life*.

Este catálogo está dedicado a aquellos profesionales que contribuyen a crear lugares y con los que deseamos proyectar el presente y el futuro de nuestras ciudades.

Lo que encontrarán dentro de *STILE* es fruto del esfuerzo de nuestro equipo y de las valiosas colaboraciones con arquitectos, diseñadores y proyectistas, con los que compartimos ideales y pasiones.

Nuestra visión: realizar una urbanización sostenible a través del *Social Design For Real Life*.

<b>CARING ISLAND</b> HOLSCHER DESIGN		38   53
<b>BAIA - PARKLET</b> STUDIO NICHETTO		54   75
MATTIELLO <b>VITAURBANA</b>		104   175
<b>METALCO COMFORT PROGRAM</b>		176   183



## CARING ISLAND 38

CARING ISLAND INDOOR	50
CARING ISLAND L	46
CARING ISLAND M	44
CARING ISLAND S	42

## BAIA - PARKLET 54

BAIA - PARKLET A	58
BAIA - PARKLET B	59
BAIA - PARKLET C	60
BAIA - PARKLET D	61
BAIA - PARKLET E	62
BAIA - PARKLET F	63
BAIA - PARKLET G	64
BAIA - PARKLET H	65
BAIA - ELEMENTS	70

## VITAUROBANA 104

<b>ALTEREGO</b>	138
ALTEREGO 1D   4V	140
ALTEREGO 4VC   1VC	145
ALTEREGO DE   TA	143
ALTEREGO FP   FS   FG	144
ALTEREGO MODELLI	148
ALTEREGO OM	146
ALTEREGO SP	141
ALTEREGO SS	142
<b>CITY OF SION</b>	106
CITY OF SION D   E	113
CITY OF SION DH   DH + S	111
CITY OF SION DW   EW	112
CITY OF SION EH   EH + S	110
<b>COBRA</b>	152
COBRA CA1   CA2	154
COBRA CR   CRS	156
COBRA CV   CO   CVS	155
COBRA MODELLI	158
COBRA SUPPORTI SV   SP	157
<b>GRANDIFIORIERE</b>	126
GRANDIFIORIERE GBA I   GBA E	134
GRANDIFIORIERE GBO   GBV	133
GRANDIFIORIERE GBR	135
GRANDIFIORIERE GSA1   GSA2	131
GRANDIFIORIERE GSO   GSV	130
GRANDIFIORIERE GSR	132
<b>ISOLAUROBANA</b>	162
ISOLAUROBANA D   W	164
ISOLAUROBANA DTS   DTS + A	165
ISOLAUROBANA FB   FA	167
ISOLAUROBANA MODELLI	168
ISOLAUROBANA WT   W2	166
<b>JARDIN</b>	114
JARDIN BA   B	120
JARDIN I   E	124
JARDIN P   C	125
JARDIN SA   SAW	121
JARDIN SCW   SLW	119
JARDIN SL   SC	118

## METALCO COMFORT PROGRAM 176

METALCO COMFORT PROGRAM	180
-------------------------	-----

<b>BENCHES   BANCOS</b>	184		
AGATA P	240	I-BOX ACCESSORIES	338
AIR - PORT A	232	I-BOX B	336
AIR - PORT C	233	IDEAS L	288
AIR - PORT L	230	IDEAS T	289
AMBRA	234	JASPER	310
AMETISTA	194	KORE	186
AMETISTA ACCESSORIES	198	LETTERE	379
ANASTASIO   MAKATITE   REALGAR	394	LIBRE	360
ANASTASIO ACCESSORIES	396	LIBRE 2.0	372
ATOLLO	212	LIBRE DOPPIA	368
AUSTEN F	237	LIBRE EVOLUTION	364
AUSTEN W	236	LIBRE SETTORE	362
<b>BAILO</b>	200	LIVE	356
BAILO I	206	LORENZ	380
BAILO W	205	MELANGE	246
BAILO WPC	204	MISS I	432
BIG HARRIS WOOD	270	MISS W	428
BIG HARRIS WPC	280	MONOLIGHT	348
BULL	235	MOOD MPT   MP	400
CAMPUS	238	MOOD MSD   MSDT	399
CANAPÈ	239	MOOD MST   MS	401
CANN	218	MOONSTONE W	354
CERRO	210	MOONSTONE	355
COLOR STYLE	227	NATURAL PUZZLE	406
CORTEN STYLE	224	NORMAN	312
CORTOMADERE CM3P   CM3S	222	<b>NORSE</b>	250
CORTOMADERE CMC	221	NORSE A2I   A2E   L   A	255
CORTOMADERE CMP   CMS	220	NORSE AE   AI	254
<b>DELTA</b>	290	NORSE LW   L2W	252
DELTA F	294	NORSE LWS   LW2S	253
DELTA B	295	NUVOLA	410
<b>DIAMANTE COLLECTION</b>	314	<b>OCEAN</b>	416
DIAMANTE 45°   15°   P	316	OCEAN HPC	418
DIAMANTE ACCESSORIES I	320	OCEAN W	419
DIAMANTE ACCESSORIES W	324	PAD	408
DIAMANTE F	317	PLATINUM COLLECTION	426
DOIS	423	PONTE A	302
DRIVE	228	PONTE W	298
EDGE SX   DX	415	RIBBON	304
EDGE SMART	414	RIVA	436
FORESTA	258	RIVOLA	444
FRANK	306	ROCH DP	438
FRECCIA	241	ROCH L	440
GAIA	262	ROCH LP	442
HARRIS ISOLA + HARRIS TREE W	272	SARAH	260
HARRIS ISOLA WPC COLLECTION	281	SEDIS   SEDIS TORSION	446
HARRIS TRAPEZIO WPC	282	SPLASH	402
HARRIS WOOD COLLECTION	266	STAGE	424
HARRIS WPC	276	STONE	342
HOBAS	219	TOSO	448
HORN	286	<b>TREE LINE</b>	386
<b>I-BOX COLLECTION</b>	328	TREE LINE C - 120°	390
		TREE LINE ACCESSORIES	392
		TRÈS	420
		TWIN	454

MIZAR S	455
TWIST	242
ULURU COLLECTION	456
UM	422
UP	449
VOLO COLLECTION	458
VOLO EVOLUTION	460

#### PICNIC AREA ÁREA PIC NIC

462

AIR - A	482
AIR - C   AIR - CS	488
AIR - CIRCLE	464
AIR - L	487
B-B SASS	490
B-BQ	491
C-BQ	492
<b>BREAK TIME</b>	468
BREAK TIME I	474
BREAK TIME TI	478
BREAK TIME TW	481
BREAK TIME W	476
MERENDA	493
PIC BULL	494
PIC NIC	495

#### LITTER BINS | PAPELERAS

496

AERO	498
AERO Q	500
AGAVE	502
BLOOM	501
BOTTE	506
BOX IRON	510
BOX LINE	511
BOX SOLID	512
BOX WOOD	508
BRAVO BOOM	516
BRAVO DOG	520
BUND	526
C3	525
CARRÈ	528
CESTIS	530
CESTUM	531
CHANDY	532
CISSUS	503
CONGA	533
CORTE	534
COVER 240	548
CUP	535
DIAMOND	536

ECOMIX	538
ECOSIDE	540
ERMES   ERMES WALL	544
GAVITELLO	507
GEMINI	541
GEMINI DOG	522
HILL	542
IRIS	546
MARCO BOOM	550
OLPE	504
PACK	552
POD	551
POUCH	521
QUAI	547
RALPH	554
ROY	556
RUBINO	555
SBIN	558
SET	560
SLICK & HOLE	515
SPENCER C	564
SPENCER CP	576
SPENCER CPP	578
SPENCER CPQ	579
SPENCER DOG	524
SPENCER E	566
SPENCER Q	568
SPENCER R	570
SPENCER T	572
SPENCER TC	574
SPENCER W	567
SUPERBRAVO	517
TOP	580
TOPAZIO	561
TULIP   TULIP BIG	586
WAVE	587
YES	588
YES W	590

#### CIGARETTE BINS CENICEROS

592

CICA	594
FÙ	595
FUMA	596
GENE	599
MÒ	598
SAND	600
SCRAMBLER	602

**BIKE RACKS | APARCABICICLETAS** 604

BAUM	606
BIELLA	616
BIKE	622
BISSA	608
CAFÈ	638
CARGO	614
CICLOS	613
CIRCLE	618
CLOS	619
CRUNA	620
CURITIBA	623
CYCLUS	621
GUARDIA	624
INSIDE	625
MOMÒ	626
PITTI B	630
PITTI M	628
RESET	632
RUOTA	610
SERVICE BIKE	634
SMERALDO	636
SPYRA	639
SPYRA CL	640

**BOLLARDS AND BARRIERS  
BOLARDOS Y VALLAS** 644

BAND	646
CORALLO	648
CUBE	650
DIFFUSION NEWS	652
DIVIDIT	680
DIX	653
EXPLOSION	654
GENESIS	655
GITTER	656
HESPERIA	659
HOLLOW	660
ISTRA	664
MASCHERA	666
MOKA	668
OVAL	671
PALUS	670
PENCIL	667
PIREO	672
QUICK	673
ROUGH	674
RUOTE	678
SIGARO	679

TI	662
TRANSEO	684
URBAN SCREEN	682
VERSO P   X	685
VISION	686
WORD	688
ZAFFIRO	689

**PLANTERS AND PLANT  
PROTECTORS  
JARDINERAS Y ALCORQUES** 690

ALFA   BETA   GAMMA	692
ARBORIS	723
ASTER	696
BALL	698
BALZAC F	701
BALZAC W	700
BAMBÙ	697
DAHLIA	702
FLÒ	704
FLORA	720
FLORES	703
LAND	722
LITTERA	718
LOUNGE	706
OBRA C   R	724
OBRA Q	725
ONICE	708
PARABEL L	714
PARABEL S	712
PERLA C	728
PERLA Q	726
PITOCCHA	707
SIZE	717
STELO	721
SUNNY	727
TRIANGLE	716
TWISTER	729

**DRINKING FOUNTAINS  
FUENTES** 730

FUENTE C   E   R	736
FUENTE DOG	734
PARAGUAS	733

**DISPLAY UNITS AND POLES**  
**EXPOSITORES Y PANELES**  
**INFORMATIVOS**

738

ALTUS   LATUS	740
ANNUNCI	741
ASPEN	744
ATHOS	746
BACH	745
BARDO	742
CHAMONIX	750
DUPLUS   PARVUS   SINGULA	752
ICARO	748
LEGGIO	753
PARANÀ	754
SENNÀ	756
TARGA	757

**SHELTERS**  
**MARQUESINAS**

758

ALHENA	764
ARENA BIKE	770
ARTS	768
ATENA	766
ATLANTICO	760
CABINEDDA	772
FOGLIA	776
GARDA	782
GPDUE	784
HUT	778
MERAK	765
NORT	790
PARTNERS	775
PENSILIS 1223	786
PENSILIS 1722	788
RIO	794
SELF	774
SINTESI	777
UMBREL	798

**SUSTAINABLE CHOICES**  
**ELECCIONES SOSTENIBLES**

800

Legend | Leyenda  
 H: height | altura  
 P: depth | profundidad  
 L: length | longitud



# SOCIAL DESIGN FOR REAL LIFE



At Metalco, we have made Social Design for Real Life our mission: that is our way to make street furniture in order to get a sustainable urbanization for the environment and people, listening to the needs of today without sacrificing the necessities of tomorrow. Therefore:

Nosotros, en Metalco, hemos hecho del Social Design for Real Life nuestra misión: es nuestro modo de crear mobiliario urbano al servicio de una urbanización que sea sostenible para el medio ambiente y para las personas, prestando especial atención a las exigencias actuales, sin sacrificar las necesidades futuras. Por ello:

# THE MANIFESTO OF A SUSTAINABLE *STILE*

## El manifiesto de un *Stile* sostenible

### WE PROMOTE SOCIALITY

because there is no well-being without personal connections.

### WE OBSERVE REAL LIFE

starting by listening to individual in order to understand the entire community.

### WE INSTILL A SENSE OF BELONGING

so that every person can feel safe and welcome not just at home, but also in all collective spaces, in their own cities and around the world.

### WE CARE ABOUT THE ENVIRONMENT

because it is a precious resource that must be protected. With our products and processes, we help to make street furniture projects around the world more sustainable.

### WE LOVE DESIGN AND CREATIVE FREEDOM

because only by combining them we can turn street furniture into Social Design for Real Life.

### WE DO ALL OF THIS AND WE DO IT WITH *STILE*.

---

### PROMOVEMOS LA SOCIABILIDAD

porque si no hay conexión entre las personas, no hay bienestar.

### OBSERVAMOS LA VIDA REAL

Comenzamos escuchando a cada persona individualmente, para llegar a entender a toda la comunidad.

### TRANSMITIMOS UN SENTIDO DE PERTENENCIA

para que cada persona pueda sentirse segura y acogida no solo en casa, sino también en todos los espacios comunes, de su propia ciudad y del mundo entero.

### RESPETAMOS EL MEDIO AMBIENTE

porque es un recurso muy valioso que debe tutelarse.

Con nuestros productos y procesos, contribuimos a hacer más sostenibles los proyectos de mobiliario urbano en todo el mundo.

### AMAMOS EL DISEÑO Y LA LIBERTAD CREATIVA

porque solo uniéndolos podemos transformar el mobiliario urbano en Social Design For Real Life.

### SABEMOS HACER TODO ESTO Y LO HACEMOS CON *STILE*.





**WE PROMOTE  
SOCIALITY**

Promovemos  
la sociabilidad

Cities and their collective spaces should be tailored to people, designed for their well-being.

It is not enough to just provide new services, study better urban planning or include more technology in everyday life. We also need to promote sociality, creating the right conditions for people to socialize, work, learn and even play in a welcoming environment.

That is why we offer VITAURBANA collections, characterized by modular and compatible elements to create large islands of sociality, seating options that are more than just benches, becoming meeting places, such as ATOLLO or HARRIS ISOLA, or solutions for outdoor conviviality such as AIR and the BREAK TIME series.

It is all street furniture that becomes a meeting place in and of itself.

---

Las ciudades y sus espacios comunes deberían estar hechos a medida de las personas, pensados para su bienestar.

No es suficiente solo implementar nuevos servicios, estudiar una mejor planificación urbana o incluir más tecnología en la vida diaria, es necesario promover la sociabilidad, creando las condiciones adecuadas para que las personas puedan socializar, trabajar, aprender e incluso jugar en un lugar que les acoja.

En este sentido, proponemos las colecciones de VITAURBANA, caracterizadas por elementos modulares y componibles para crear grandes islas de sociabilidad, asientos que no sólo son ASIENTOS, sino lugares de agregación como ATOLLO o HARRIS ISOLA, o soluciones para la convivencia fuera de nuestros hogares como AIR y la serie BREAK TIME.

Se trata de un mobiliario urbano que constituye, en sí mismo, un lugar de encuentro.



A man with curly hair, wearing a white long-sleeved shirt and white trousers, is walking on a modern, illuminated structure. The structure consists of a central vertical pole and several large, circular, ribbed canopies that resemble umbrellas or light fixtures. The scene is set against a dark background, possibly at night, with the structure's lights providing the primary illumination. The man is captured in a dynamic, walking pose, looking towards the camera.

**WE OBSERVE  
REAL LIFE**

Observamos  
la vida real

We firmly believe that we all deserve more sustainable, more inclusive collective places that help us to realize our potential, not just as individuals, but also as communities.

We always choose to put people at the centre of our creative process: we study everyday life and big or small daily challenges, and we try to understand what the needs of urban areas are.

We start with individuals, because they have to feel they are part of a context that supports them, that offers solutions to their needs, because their satisfaction is what creates sense of community.

We then try to make way for the community to express itself, so that it may find meeting points, opportunities for expression and new cohesion.

In so doing, thanks to our in-depth collaborations with great, visionary minds, we have created something that was not there before, but we felt it was necessary to real everyday life: the 'green' vision of SUPERVERDE, the sustainable sociality of our PARKLETS, the inclusivity of CARING ISLAND, the comfort of OMBRA IN CITTÀ, and the social language of URBAN MIRROR come together with hundreds of other products (modular and otherwise): design solutions, and views about street furniture at the service of the needs of individuals and communities.

---

Estamos convencidos de que cada uno de nosotros merece lugares comunes más sostenibles e inclusivos, que estén a la altura de nuestras potencialidades, no sólo como individuos, sino también como comunidad.

Queremos que las personas estén en el centro de nuestro proceso creativo: estudiamos la vida diaria, los pequeños y grandes desafíos cotidianos, intentamos entender cuáles son las necesidades en un ambiente urbano.

Partimos de los individuos, porque deben sentirse parte de un contexto que les apoya, que les ofrece soluciones adecuadas a sus necesidades, porque de su satisfacción nace el sentido de comunidad.

A continuación, dejamos a la comunidad que se exprese, para que encuentre puntos de encuentro, espacios de expresión y nueva cohesión.

Así, gracias a una profunda colaboración con grandes y visionarias mentes, hemos creado algo que antes no existía, pero que creíamos que era necesario para la cotidianidad de la vida real: la visión ecológica de SUPERVERDE, la sociabilidad sostenible de los PARKLET, la inclusión de CARING ISLAND, el confort de OMBRA IN CITTÀ y el lenguaje social de URBAN MIRROR se unen con centenares de productos, modulares o no: soluciones de diseño, perspectivas del mobiliario urbano al servicio de los individuos y de las comunidades.



# WE INSTILL A SENSE OF BELONGING

Transmitimos un sentido  
de pertenencia





Cities, towns, and neighbourhoods are growing and so are we, as the populations who live in them.

Today, our private spaces are shrinking, but our needs are not. The amount of time spent outside our home is increasing, to retrieve the space we no longer have and to find connections. We enjoy streets, squares, railway stations and parks. We need cities made of places designed for us which allow us to express ourselves, to achieve our dreams, and to fully experience our private lives, outside the home walls.

When these places are within everyone's reach, cohesion is created, inequality is resolved and we can truly feel at ease in all collective spaces, in any city.

We bring this feeling of 'home' to the world by recreating urban living rooms with seats such as our NORMAN, JASPER and FRANK poufs; with GRANDIFIORIERE we create gardens truly enjoyable by everybody; and with the beauty of CABINEDDA, we make way for reflection and contemplation of the landscape.

---

Crecen las ciudades, los pueblos, los barrios. Y crecemos también nosotros que los habitamos.

Hoy nuestro espacio privado se restringe, pero no nuestras necesidades. Pasamos más tiempo fuera de casa, para recuperar ese espacio que nos falta y encontrar conexiones: vivimos las calles, las plazas, las estaciones, los parques... Necesitamos ciudades hechas de lugares ideados para nosotros, para que nos permitan expresarnos, realizarnos, vivir plenamente nuestra dimensión privada, fuera de las paredes de nuestros hogares.

Cuando estos lugares están al alcance de todos, se crea cohesión, se aplanan las desigualdades y podemos sentirnos verdaderamente a gusto en todos los espacios comunes, en cada ciudad.

Este sentido de "casa" lo llevamos por el mundo: reproducimos salones urbanos con asientos como los pufs NORMAN, JASPER y FRANK, con GRANDIFIORIERE se da vida a verdaderos y auténticos jardines para disfrute de todos y con la belleza de CABINEDDA dejamos espacio a la reflexión y a la contemplación del paisaje.





**WE CARE  
ABOUT THE  
ENVIRONMENT**

Respetamos el  
medio ambiente

It would be easy to settle for what we already are: a company that uses 100% sustainable, certified energy, and one that has always believed in renewables. More than 7,500 solar panels, installed on the roofs of our plants, produce clean energy, thereby ensuring that over 850 metric tonnes of CO<sub>2</sub> stay out of the environment each year.

It is not enough to carefully select our suppliers, optimize our raw materials, choose recyclable materials, and adopt virtuous manufacturing processes that have been internationally recognized through qualitative certifications.

We demand more from ourselves.

We invest in research and design to find new, increasingly sustainable and highly-performing materials to further improve our processes, because we want our furniture to last over time and to be easy and intuitive to reuse and dispose of once it has reached the end of its natural life span.

We want to change the rules of the game and help to make all street furniture projects—and thus our cities—more sustainable.

---

Sería fácil conformarse con lo que ya somos: una empresa que usa solo energía de fuentes 100% sostenibles y certificadas y que siempre ha creído en las energías renovables. Más de 7.500 paneles solares instalados en los tejados de nuestras instalaciones producen energía limpia, evitando la emisión, a la atmósfera, de más de 850 toneladas de CO<sub>2</sub> al año.

Para nosotros, no es suficiente con seleccionar cuidadosamente nuestros proveedores, optimizar las materias primas, elegir materiales reciclables y adoptar procesos productivos de vanguardia, premiados con certificaciones de calidad reconocidas a nivel internacional.

Pretendemos más de nosotros mismos.

Invertimos en investigación y desarrollo para encontrar nuevos materiales cada vez más sostenibles y eficaces, para mejorar aún más nuestros procesos, porque deseamos que el mobiliario urbano dure más tiempo, que pueda reutilizarse y eliminarse fácil e intuitivamente una vez finalizado su ciclo natural de vida.

Deseamos cambiar las reglas del juego y contribuir a hacer aún más sostenibles todos los proyectos de mobiliario urbano y con ellos, nuestras ciudades.

A person dressed in all-white clothing is performing a handstand on a red metal bench. The person's legs are raised high, with one leg bent and the other extended. The background is a dark studio space with a light-colored floor. To the left, there is a blue wire chair. In the center, a silver wire bench is visible. To the right, a brown wire chair is partially visible. The overall scene conveys a sense of creative freedom and design.

**WE LOVE  
DESIGN AND  
CREATIVE  
FREEDOM**

Amamos  
el diseño y  
la libertad

We believe in the power of design, the one which attracts with aesthetics and conquers with functionality.

We believe in the industrialization of design, the one which identifies good ideas and turns concepts into products.

We believe in the value of human creativity, individual talent, and teamwork.

We spend each day creating the most suitable products possible so that you can add your distinct signature to the world, transforming it with your projects, making them unique and unmistakable.

Our in-house team of experts, professionals and young talents does not just develop products, but it does so with our unmistakable style. Modularity, aesthetics, and functionality are just a few of the key points in a creative process that aims to offer absolute freedom of expression to all of you who are called upon to bring urban projects to life.

---

Creemos en la fuerza del diseño, el que atrae con la estética y conquista con la funcionalidad.

Creemos en la industrialización del diseño, la que identifica las buenas ideas y transforma los conceptos en productos.

Creemos en el valor de la creatividad humana, en el talento del individuo y en el trabajo en equipo.

El nuestro es un trabajo en el que nos esforzamos cada día en crear los productos más adecuados para que ustedes puedan firmar el mundo y transformarlo con sus proyectos, haciéndolos únicos e inconfundibles.

Nuestro equipo interno de expertos profesionales y jóvenes promesas, no solo desarrolla productos, sino que lo hace con un estilo inconfundible: el nuestro. Modularidad y estética asociada a la funcionalidad son solo algunos de los puntos clave de un proceso creativo que desea dejar la máxima libertad expresiva a todos ustedes, que son los encargados de realizar un proyecto urbano.

A man in a white suit is performing a handstand on a large, dark, curved structure. The structure is illuminated from the side, creating a strong contrast with the dark background. The man is upside down, with his legs tucked and arms supporting his weight. The overall scene is dramatic and artistic.

**WE KNOW-HOW  
WITH *STILE***

Saber hacer  
con *STILE*

We believe in creativity, but we know this is not enough on its own: to implement creativity, you also need technique, know-how and production capacity.

We are a company made up of people, of professionals, each of us with our own expertise, skills, and attitudes.

We rely on the strength of our group, The Placemakers, and on our four production facilities, for a total of over 100,000 m<sup>2</sup>. Here, we blend innovative technologies with our expertise and ability to work steel, aluminium, wood, and concrete.

But it is not enough: we constantly invest in research and development, cutting-edge machinery, and new production techniques to obtain ever better and certified performance, while paying respect to the utmost environmental concerns.

For this purpose, Atoms was established, our Group's scientific lab, which is committed to scientific and chemical research to enable us to employ new materials and increasingly sustainable processes.

Finally, we never forget the importance of listening to our clients and understanding and meeting their needs.

We succeed thanks to our team, our offices in Europe, Latin America and the Middle East, and our extensive network of business partners present throughout the world.

All this makes up our *STILE*.

---

Creemos en la creatividad, pero sabemos que, por si sola, no es suficiente: para ponerla en práctica, se necesita técnica, know-how y capacidad productiva.

Somos una empresa formada por personas, profesionales, cada uno con sus propias habilidades y actitudes.

Contamos con la fuerza de un grupo, The Placemakers y con cuatro plantas de producción, con una superficie total de más de 100.000 m<sup>2</sup>, donde tecnologías innovadoras se encuentran con nuestro saber hacer, nuestra capacidad para trabajar acero y aluminio, madera y hormigón.

Pero todo esto no nos basta: seguimos invirtiendo constantemente en investigación y desarrollo, en maquinaria de última generación, en nuevas técnicas de producción para obtener un rendimiento cada vez mejor y certificado, respetando el medio ambiente.

Para ello nace Atoms, el laboratorio científico de nuestro Grupo, que se apoya en la investigación científica y la química para permitirnos utilizar nuevos materiales y procesos cada vez más sostenibles.

Por último, nunca nos olvidamos de escuchar, comprender y satisfacer las necesidades de nuestros clientes.

Lo hacemos gracias a nuestro equipo, nuestras filiales en Europa, América Latina y Oriente Medio, y una amplia red de socios comerciales presentes en todo el mundo.

Todo esto está en nuestro *STILE*.

# HOLSCHER DESIGN

---



# CARING ISLAND: DESIGNED AROUND THE CONNECTION BETWEEN ADULTS AND CHILDREN

Caring Island:  
diseñado en torno a la  
conexión entre grandes  
y pequeños



CARING ISLAND







## A new paradigm for an inclusive sociality

Holscher Design has developed for Metalco a new type of street furniture “tailored to... adult”: a welcoming oasis for all those adults who are called to take care of the youngest. This project, born from a profitable dialogue with Inglesina, the company that for over 50 years is close to children all over the world, introduces innovative elements that normally would not find space in public places. Circular pavilions, inspired by natural spaces, become real modular equipped areas, equipped with changing tables, benches for breastfeeding, parking for strollers, seats and tables: the ideal place to help adults to be close to children, in maximum comfort and in full sociality.

## Un nuevo paradigma para una sociabilidad inclusiva

Holscher Design ha desarrollado para Metalco una nueva tipología de mobiliario urbano “a la medida de... adulto”: un acogedor oasis para todos aquellos mayores que están llamados a cuidar de los más pequeños. Este proyecto, que nace de un provechoso diálogo con Inglesina, empresa dedicada, desde hace más de 50 años, a los más pequeños de todo el mundo, introduce elementos innovadores que normalmente no suelen hacerse un hueco en lugares públicos. Los pabellones circulares, inspirados en los espacios naturales, se convierten en auténticas áreas modulares equipadas con cambiadores, asientos para la lactancia, estacionamientos para cochecitos y sillecitas, asientos y mesas: el lugar ideal para ayudar a los “grandes” a permanecer cerca de los niños, disfrutando del máximo confort y en plena sociabilidad.

PARKING FOR STROLLERS  
ESTACIONAMIENTO PARA  
COCHECITOS Y SILLETAS

SPACE FOR BREASTFEEDING  
ESPACIO PARA LA LACTANCIA

AREA FOR CHILDREN  
ZONA INFANTIL

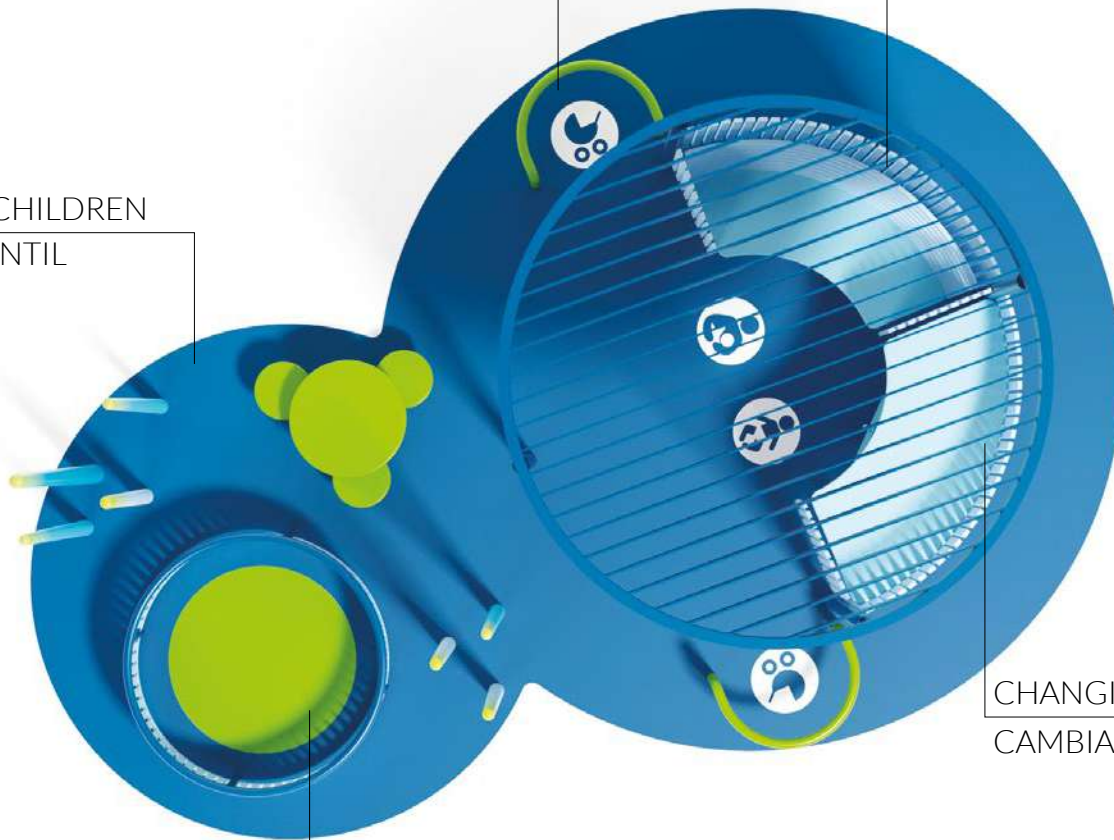

CHANGING TABLE  
CAMBIADOR

FENCED AREA FOR CHILDREN  
ZONA INFANTIL RECINTADA



Outdoor structure consisting of two different functional areas. The first is equipped with a circular shading structure, a semicircular panel that protects both a top, that serves as a changing table, and a system of seats with backrest, dedicated to breastfeeding. The area is equipped with two steel structures that serve as parking for prams and strollers. The second area is equipped with vertical decorative elements, a circular fence that identifies a protected play area for children and a system of stools and a round table for children.

Estructura de exterior formada por dos áreas funcionales. La primera está constituida por una sombrilla circular, por un panel semicircular que cubre una superficie equipada con cambiador y una zona de asientos con respaldo, reservada para la lactancia. El área está provista de dos estructuras en acero que sirven como estacionamiento de cochecitos y silleas de bebé. La segunda zona está formada por un recinto circular que sirve de zona de juegos protegida para niños.

## CARING ISLAND S

Designer:	Holscher Design
Dimensions/Dimensiones:	5400x4820 mm H 2500 mm
Materials/Materiales:	Powder coated steel + Okumé plywood Acero pintado + Contrachapado de Okumé
Fixing/Fijación:	Installation with threaded bars Cimentación con varillas roscadas

Conceived with  
Estudiado con

**Inglesina**

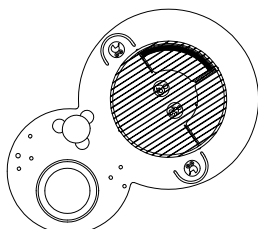
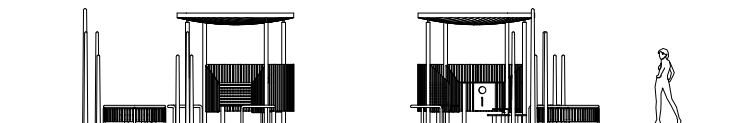



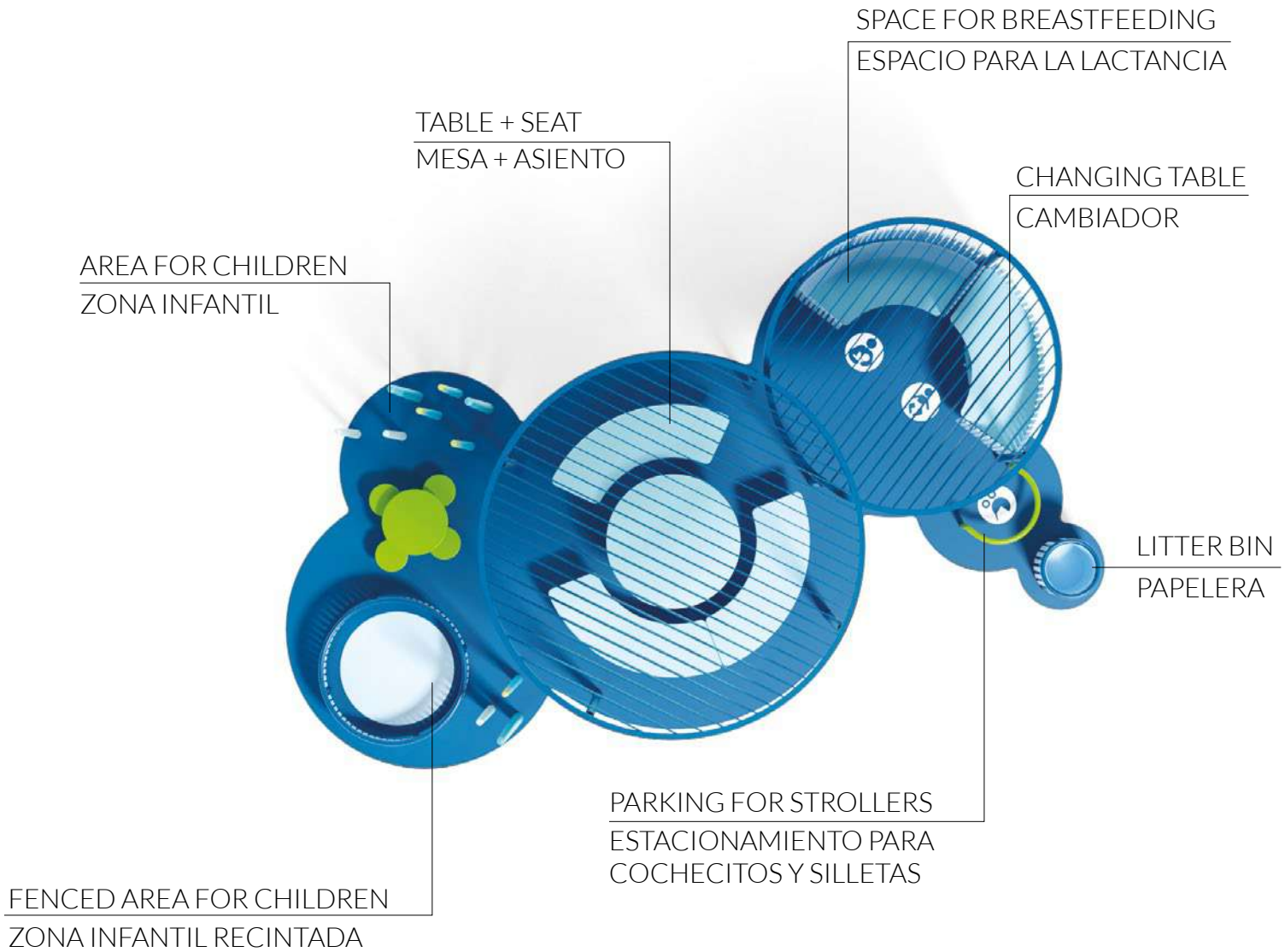

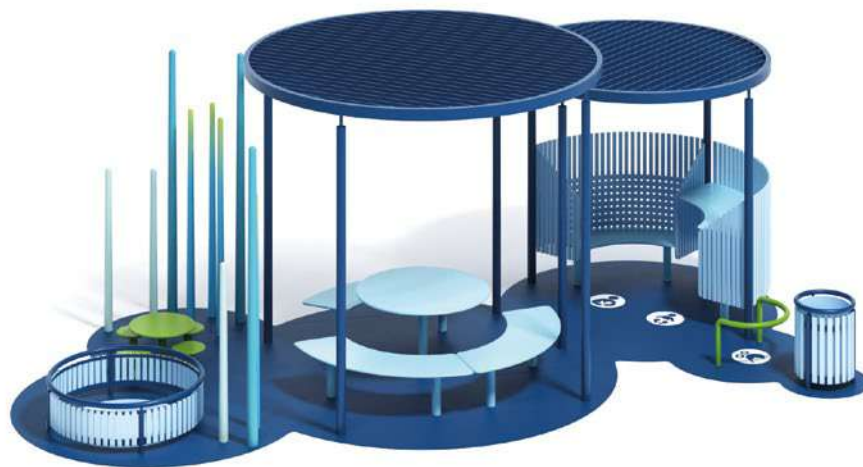

Outdoor structure consisting of two different functional areas. The first is equipped with a circular shading structure, a semicircular panel that protects both a top, that serves as a changing table, and a system of seats with backrest, dedicated to breastfeeding. The area is equipped with two steel structures that serve as parking for prams and strollers. The second area is equipped with vertical decorative elements, a circular fence that identifies a protected play area for children and a system of stools and a round table for children.

Estructura de exterior formada por dos áreas funcionales. La primera está formada por una sombrilla circular, por un panel semicircular que cubre una superficie equipada con cambiador y una zona de asientos con respaldo, reservada para la lactancia. El área está provista de dos estructuras en acero que sirven como estacionamiento de cochecitos y silleas de bebé. La segunda zona está formada de elementos decorativos verticales, de un recinto circular que sirve de zona de juegos protegida para niños y de un sistema de taburetes y mesa circular para niños.

## CARING ISLAND M

Designer:	Holscher Design
Dimensions/Dimensiones:	7390x3900 mm H 2800 mm
Materials/Materiales:	Powder coated steel + Okumé plywood Acero pintado + Contrachapado de Okumé
Fixing/Fijación:	Installation with threaded bars Cimentación con varillas roscadas

Conceived with  
Estudiado con

**Inglesina**

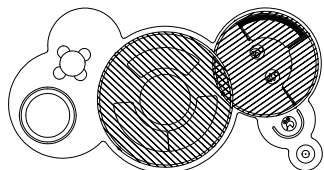

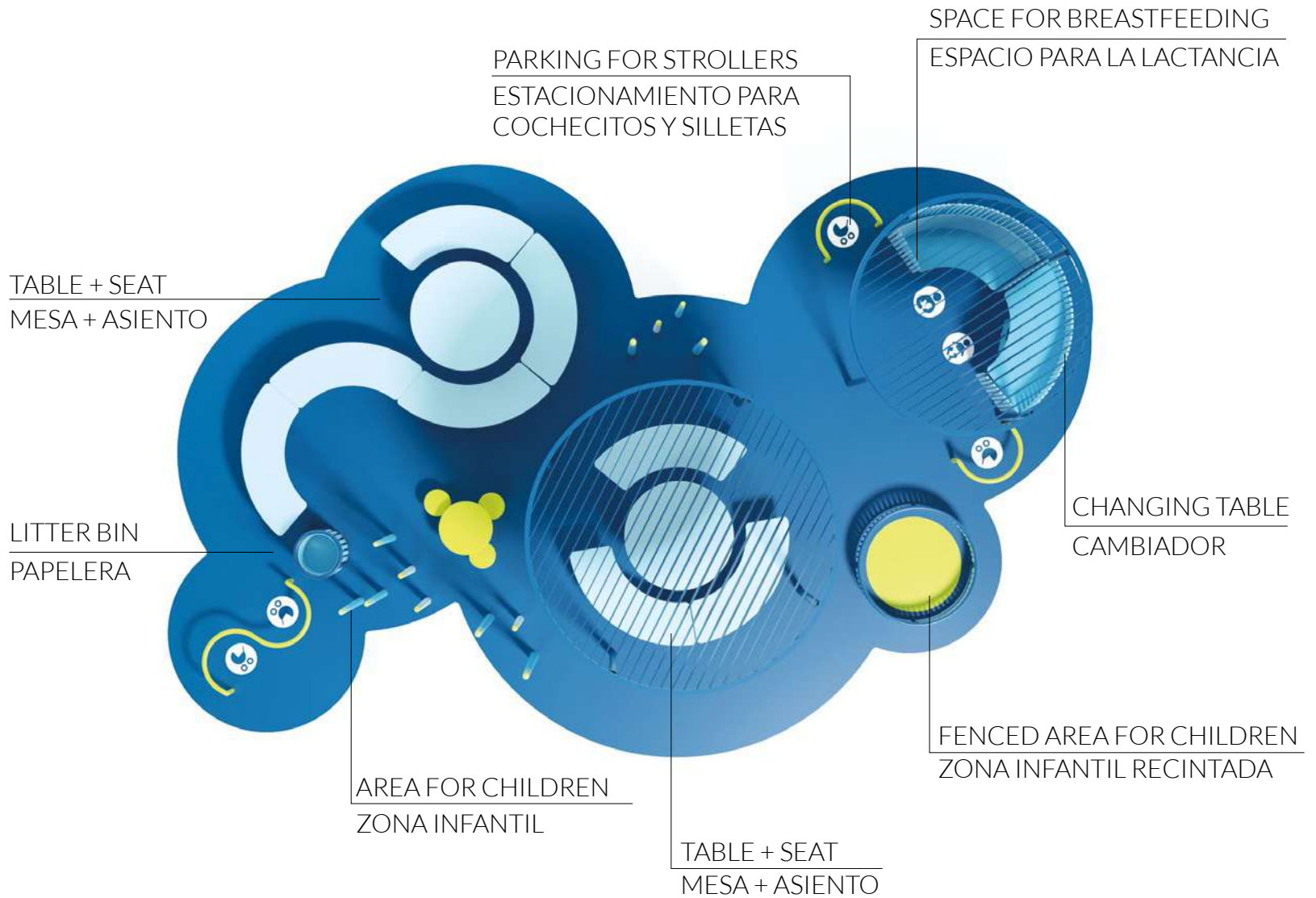

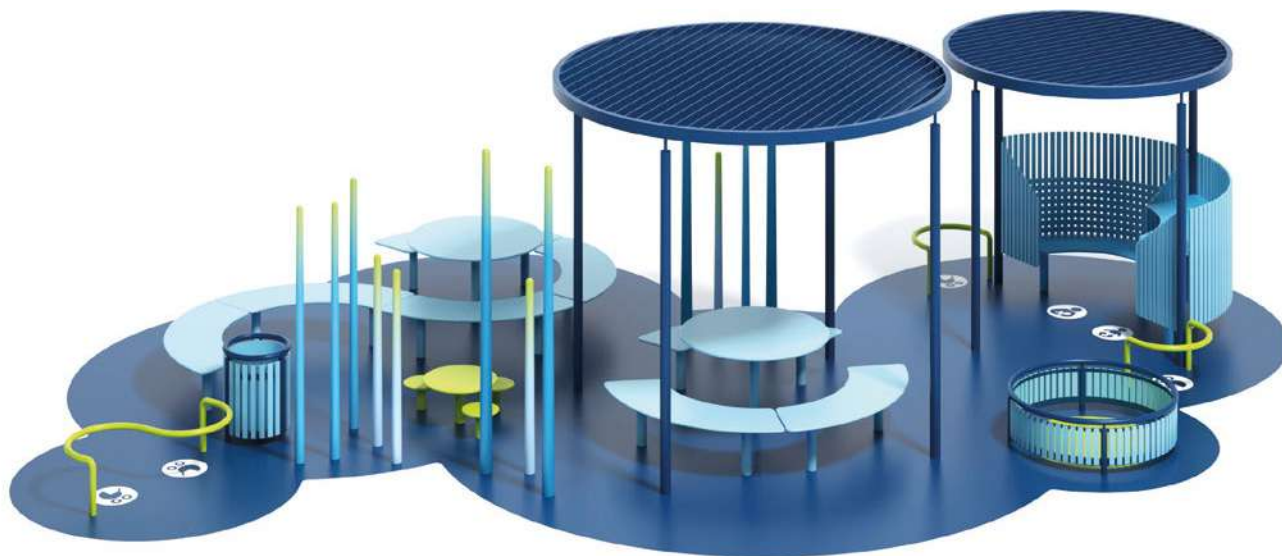

Outdoor structure consisting of three different functional areas. The first is equipped with a circular shading structure, a semicircular panel that protects both a top, that serves as a changing table, and a system of seats with backrest, dedicated to breastfeeding. The area is equipped with two steel structures that serve as parking for prams and strollers and a circular fence that identifies a protected play area for children. The second area is equipped with a circular shading structure, a system of benches without backrest with a round table, a system of stools and a round table for children and vertical decorative elements. The third area is equipped with an S-shaped steel structure that serve as parking for prams and strollers, a cylindrical litter bin with a steel structure, a system of benches without backrest that are arranged in an "S" shape, a round table and vertical decorative elements.

Estructura de exterior formada por tres áreas funcionales. La primera está formada por una sombrilla circular, por un panel semicircular que cubre una superficie equipada con cambiador y una zona de asientos con respaldo, reservada para la lactancia. El área está provisto de dos estructuras en acero que sirven como estacionamiento de cochecitos y silleas de bebé y de un recinto circular que sirve de zona de juegos protegida para niños. La segunda zona está formada por una sombrilla circular, por un conjunto de asientos sin respaldo con mesa circular, por un conjunto de taburetes y mesa circular para los niños y de elementos decorativos verticales. La tercera consta de una estructura en "S" en acero que sirve para el estacionamiento de cochecitos y silleas de bebé, de una papelera cilíndrica con estructura de acero y de un sistema de asientos sin respaldo posicionados en "S" y mesa circular y elementos decorativos verticales.

## CARING ISLAND L

Designer:	Holscher Design
Dimensions/Dimensiones:	10400x6675 mm H 2800 mm
Materials/Materiales:	Powder coated steel + Okumé plywood Acero pintado + Contrachapado de Okumé
Fixing/Fijación:	Installation with threaded bars Cimentación con varillas roscadas

Conceived with  
Estudiado con

**Inglesina**

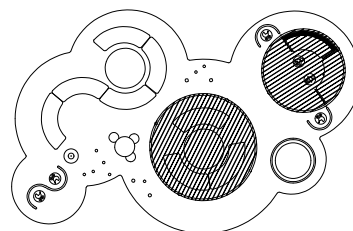
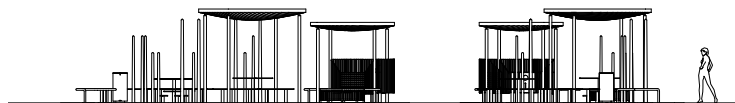



CARING ISLAND







CARING ISLAND INDOOR

PARKING FOR STROLLERS  
ESTACIONAMIENTO PARA  
COCHECITOS Y SILLETAS

AREA FOR CHILDREN  
ZONA INFANTIL

FENCED AREA FOR CHILDREN  
ZONA INFANTIL RECINTADA

SPACE FOR BREASTFEEDING  
ESPACIO PARA LA LACTANCIA

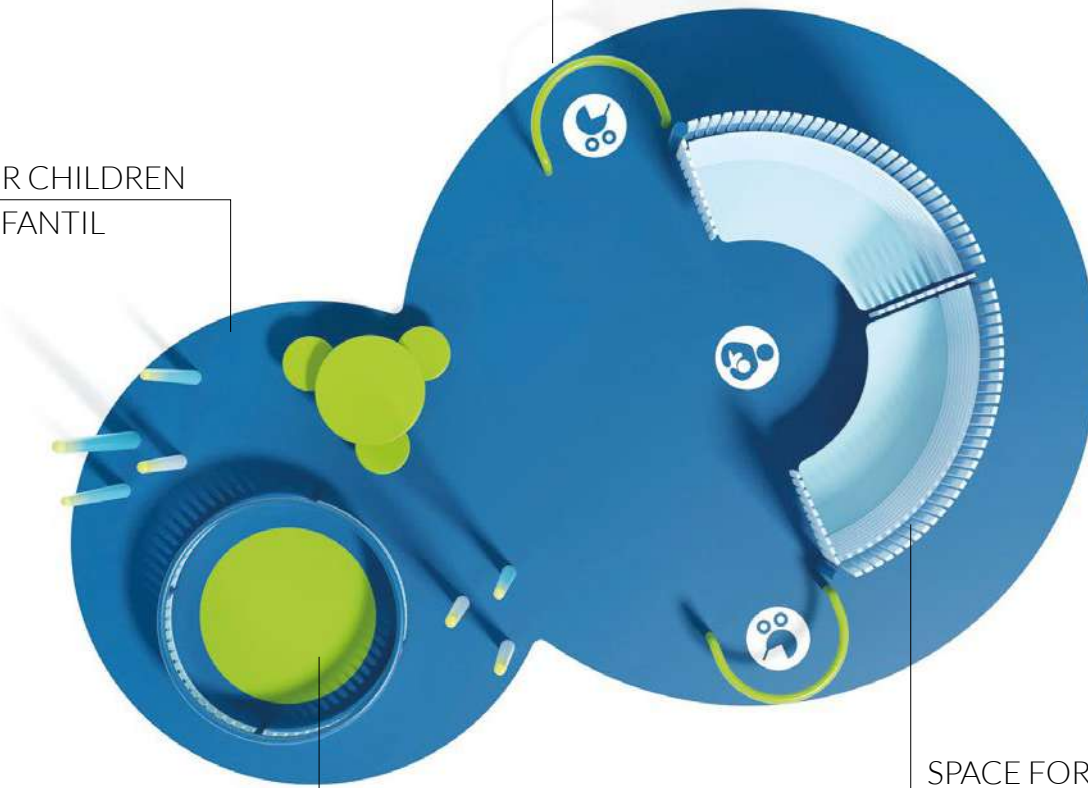

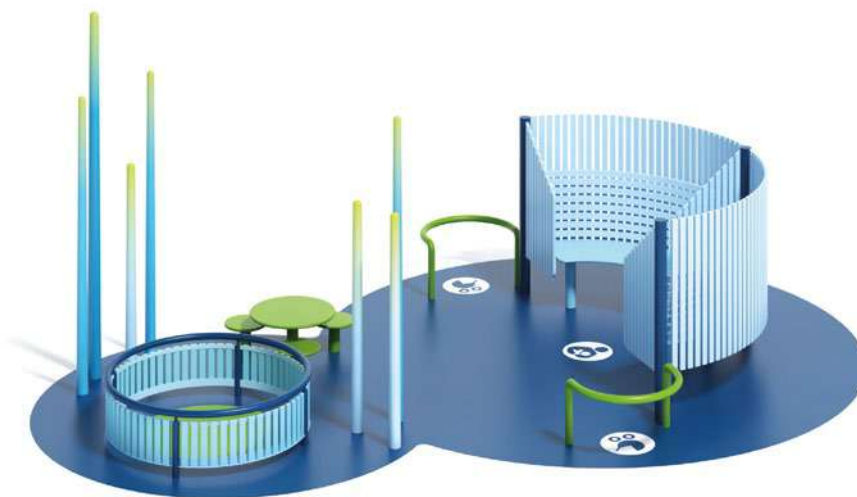

Indoor structure consisting of two different functional areas. The first is equipped with a semicircular panel that protects both a top that serves as a changing table, and a system of seats with backrest, dedicated to breastfeeding. The area is equipped with two steel structures that serve as parking for prams and strollers. The second area is equipped with vertical decorative elements and a circular fence that identifies a protected play area for children.

Estructura de interior formada por dos áreas funcionales. La primera está constituida por un panel semicircular que protege sea una superficie equipada con cambiador, sea una zona de asientos con respaldo, reservada para la lactancia. El área está provista de dos estructuras en acero que sirven como estacionamiento de cochecitos y silleas de bebé. La segunda zona está formada por elementos decorativos verticales y de un recinto circular que componen una zona de juegos protegida para niños.

## CARING ISLAND INDOOR

Designer:	Holscher Design
Dimensions/Dimensiones:	5400x4820 mm H 2500 mm
Materials/Materiales:	Powder coated steel + Okumé plywood Acero pintado + Contreplaqué d'Okumé
Fixing/Fijación:	Installation with threaded bars Cimentación con varillas roscadas

Conceived with  
Estudiado con

**Inglesina**

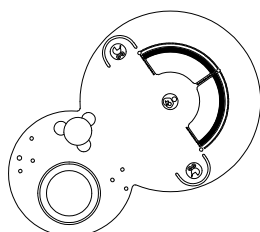



CARING ISLAND

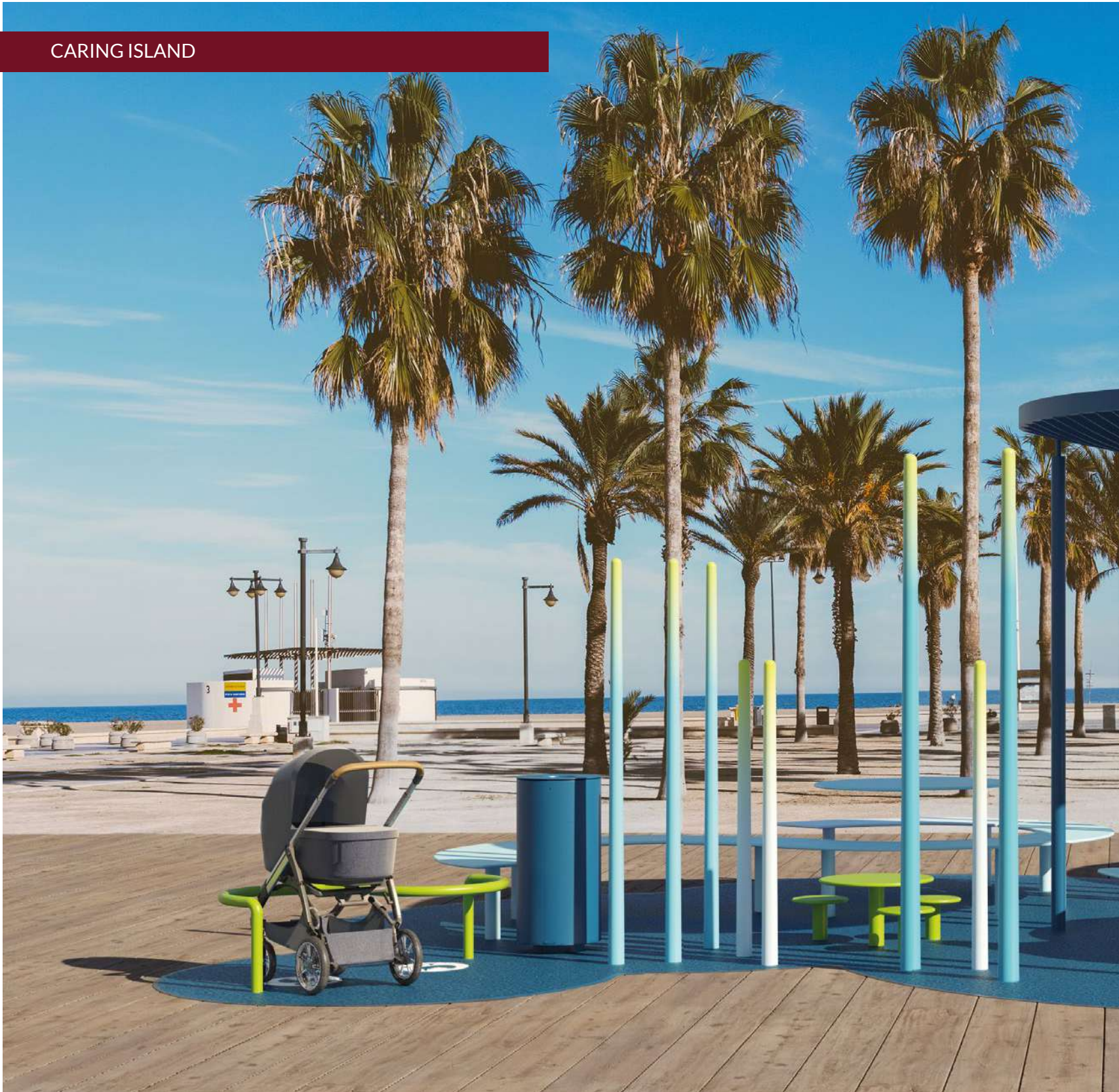





# NICHETTO STUDIO

---



# BAIA - PARKLET: A REFUGE FROM HECTIC CITY LIFE

Baia - Parklet:  
un refugio de la  
vida frenética  
de la ciudad



BAIA - PARKLET







## Creative *outlet* redefined

Born for the first time in San Francisco, Parklets are the answer to give new life to urban spaces: an ideal meeting point and a piece of furniture capable of instilling a sense of identity and recognizability within the urban context. Starting from a reflection on the habits and needs of living in the city, Luca Nichetto has created for Metalco Baia, a modular system of platforms that redefines the very concept of Parklet, offering a series of functional elements designed to create welcoming areas, protected, capable of instilling a sense of warmth and belonging, where outdoor life inspires, finding perfect harmony with design.

## Creative *outlet* redefined

Los Parklet, surgidos por primera vez en San Francisco, son la respuesta para ofrecer una nueva vida a los espacios urbanos: un punto de encuentro ideal y un elemento de mobiliario, que infunde un sentido de identidad e identificación dentro del marco ciudadano. Luca Nichetto ha creado Baia para Metalco, un sistema modular de plataformas, que redefine el concepto de Parklet, ofreciendo una serie de elementos funcionales, pensados para crear áreas acogedoras, protegidas, capaces de transmitir un sentido de calidez y pertenencia y donde la vida al aire libre inspira, encontrando una perfecta armonía con el diseño.



## BAIA - PARKLET A

Designer:	Nichetto Studio
Dimensioni/Dimensions:	4800x2000 mm H 1180 mm
Materiali/Matériaux:	CLS o WPC Ultra + Powder coated steel + HPC + HPL CLS o WPC Ultra + Acero pintado + HPC + HPL
Finiture/Finitions:	HPC Velluto - Natural smooth HPC Velluto - Liso natural
Fissaggio/Fixation:	Freestanding with pedestals or Installation with threaded bars Apoyo con pies o Cimentación con varillas roscadas

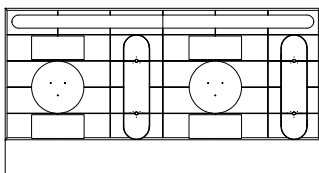
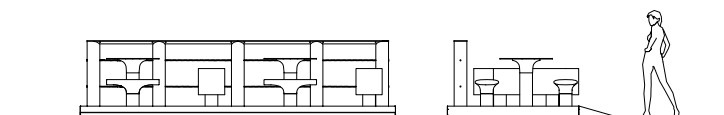

Parklet module composed of a platform with a decorative steel band, composed of a steel frame with flooring in concrete plates or slats in WPC Plus (Wood Polymer Composite) and a parapet with supporting structure in steel tube, equipped with glass panel or stainless steel ropes, arranged horizontally, with upper element in HPL (High Pressure Laminate). The platform accommodates two compositions, both composed of two single benches without backrest with table and planter. The benches are composed of a seat in HPC (High Performance Concrete) and a central steel support. The tables are composed of a steel base and a circular top in HPL (High Pressure Laminate) that stands on a support in HPC (High Performance Concrete). The planter is composed of a steel sheet structure elevated by supports. The module can be installed individually or in composition with the other platforms of the Baia Parklet collection.

Módulo parklet formado por una plataforma con un listón decorativo de acero, compuesto por una estructura de acero con el suelo en losas de hormigón o laminas de WPC Plus (Wood Polymer Composite) y un parapeto con estructura portante en tubo de acero, equipado con un panel de vidrio o alambre de acero Inoxidable, dispuesto horizontalmente, con un elemento superior en HPL (High Pressure Laminate). La plataforma alberga dos composiciones, ambas formadas por dos asientos monoplaza sin respaldo, con mesa y jardinera. Los asientos se componen de un asiento de HPC (High Performance Concrete) y de un soporte central de acero. Las mesas constan de una base de acero y una superficie circular en HPL (High Pressure Laminate) que se apoya sobre un soporte en HPC (High Performance Concrete). La jardinera está compuesta de una estructura en chapa de acero elevada por soportes. El módulo se puede instalar individualmente o en composición, combinándolo con el resto de las plataformas de la colección Baia Parklet.



Parklet module composed of a platform with a decorative steel band, composed of a steel frame with flooring in concrete plates or slats in WPC Plus (Wood Polymer Composite) and a parapet with supporting structure in steel tube, equipped with glass panel or stainless steel ropes, arranged horizontally, with upper element in HPL (High Pressure Laminate). The platform accommodates two compositions, both composed of two high benches without backrest with high table, equipped with cover.

The benches are composed of a seat in HPC (High Performance Concrete) and a central steel support. The tables are composed of a steel base and a circular top in HPL (High Pressure Laminate) that stands on a support in HPC (High Performance Concrete). The cover is composed of a steel support with opaline methacrylate upper element predisposed for LED lighting. The module can be installed individually or in composition with the other platforms of the Baia Parklet collection.

Módulo parklet formado por una plataforma con un listón decorativo de acero, compuesto por una estructura de acero con el suelo en losas de hormigón o laminas de WPC Plus y un parapeto con estructura portante en tubo de acero, equipado con un panel de vidrio o alambre de acero inoxidable, dispuesto horizontalmente, con un elemento superior en HPL (High Pressure Laminate).

La plataforma alberga dos composiciones, ambas formadas por dos asientos altos sin respaldo, con mesa de bar y una cobertura. Los asientos se componen de un asiento en HPC (High Performance Concrete) y de un soporte central de acero. Las mesas constan de una base de acero y una superficie circular en HPL (High Pressure Laminate) que se apoya sobre un soporte en HPC (High Performance Concrete). La cobertura está formada por un soporte de acero con un elemento superior en metacrilato opalino, diseñado para albergar la iluminación LED. El módulo se puede instalar individualmente o en composición, combinándolo con el resto de las plataformas de la colección Baia Parklet.

## BAIA - PARKLET B

Designer:	Nichetto Studio
Dimensioni/Dimensions:	4800x2000 mm H 2900 mm
Materiali/Matériaux:	CLS o WPC Ultra + Powder coated steel + HPC + HPL CLS o WPC Ultra + Acero pintado + HPC + HPL
Finiture/Finitions:	HPC Velluto - Natural smooth HPC Velluto - Liso natural
Fissaggio/Fixation:	Freestanding with pedestals or Installation with threaded bars Apoyo con pies o Cimentación con varillas roscadas

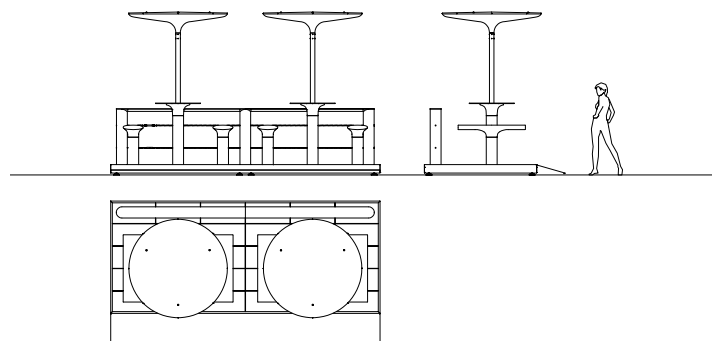

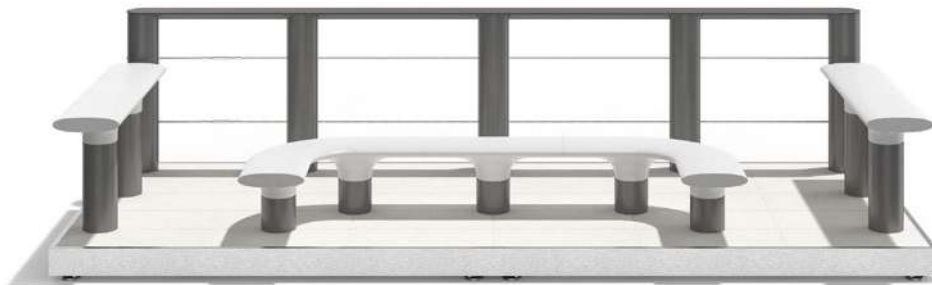

## BAIA - PARKLET C

Designer:	Nichetto Studio
Dimensions/Dimensiones:	4800x2000 mm H 1180 mm
Materials/Materiales:	CLS o WPC Ultra + Powder coated steel + HPC + HPL CLS o WPC Ultra + Acero pintado + HPC + HPL
Finishes/Acabados:	HPC Velluto - Natural smooth HPC Velluto - Liso natural
Fixing/Fijación:	Freestanding with pedestals or Installation with threaded bars Apoyo con pies o Cimentación con varillas roscadas

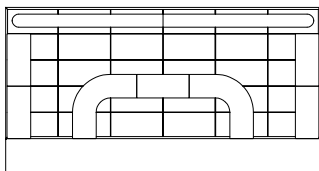
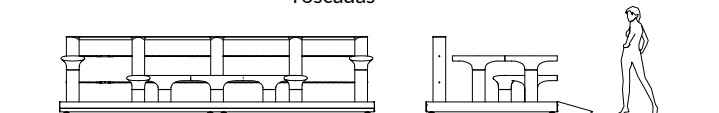

Parklet module composed of a platform with a decorative steel band, composed of a steel frame with flooring in concrete plates or slats in WPC Plus (Wood Polymer Composite) and a parapet with supporting structure in steel tube, equipped with glass panel or stainless steel ropes, arranged horizontally, with upper element in HPL (High Pressure Laminate). The platform accommodates a composition composed of two high benches without backrest, arranged on the sides of the platform, and a central system of benches without backrest, with two curved elements and a linear one, arranged in a "C". All the benches are composed of a seat in HPC (High Performance Concrete) and a central steel support. The module can be installed individually or in composition with the other platforms of the Baia Parklet collection.

Módulo parklet formado por una plataforma con un listón decorativo de acero, compuesto por una estructura de acero con el suelo en losas de hormigón o lamas WPC Plus y un parapeto con estructura portante en tubo de acero, equipado con un panel de vidrio o alambre de acero Inoxidable, dispuesto horizontalmente, con elemento superior en HPL (High Pressure Laminate).

La plataforma alberga dos composiciones, ambas formadas por dos asientos altos sin respaldo situados a ambos lados de la plataforma y de un sistema central de asientos sin respaldo, con dos elementos curvos y uno lineal, dispuestos en "C". Todos los asientos están hechos de HPC (High Performance Concrete) y un soporte central de acero. El módulo se puede instalar individualmente o en composiciones combinándolo con el resto de las plataformas de la colección Baia Parklet.

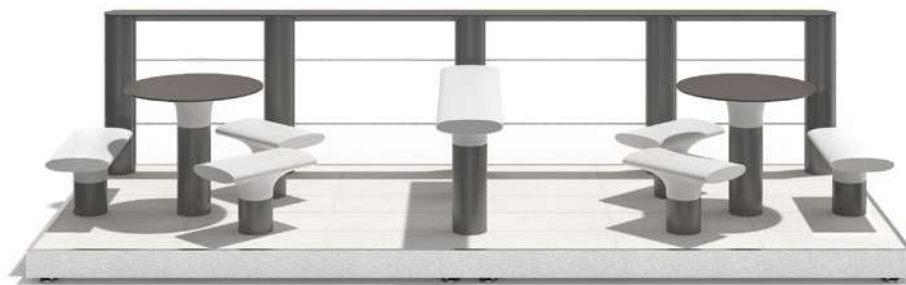

Parklet module composed of a platform with a decorative steel band, composed of a steel frame with flooring in concrete plates or slats in WPC Plus (Wood Polymer Composite) and a parapet with supporting structure in steel tube, equipped with glass panel or stainless steel ropes, arranged horizontally, with upper element in HPL (High Pressure Laminate). The platform accommodates two compositions, both composed of three single benches without backrest with table. The benches are composed of a seat in HPC (High Performance Concrete) and a central steel support. The tables are composed of a steel base and a circular top in HPL (High Pressure Laminate) that stands on a support in HPC (High Performance Concrete). The two compositions are separated by a high bench without backrest in HPC (High Performance Concrete) with central steel supports, placed in the center of the platform. The module can be installed individually or in composition with the other platforms of the Baia Parklet collection.

Módulo parklet formado por una plataforma con un listón decorativo de acero, compuesto por una estructura de acero con el suelo en losas de hormigón o laminas de WPC Plus y un parapeto con estructura portante en tubo de acero, equipado con un panel de vidrio o alambre de acero inoxidable, dispuesto horizontalmente, con elemento superior en HPL (High Pressure Laminate).

La plataforma alberga dos composiciones, ambas formadas por tres asientos monoplaza sin respaldo, con mesa. Los asientos se componen de un asiento en HPC (High Performance Concrete) y de un soporte central de acero. Las mesas constan de una base de acero y una superficie circular en HPL (High Pressure Laminate) que se apoya sobre un soporte en HPC (High Performance Concrete). Las dos composiciones están separadas por un asiento alto sin respaldo en HPC (High Performance Concrete) con soportes centrales en acero, posicionado en el centro de la plataforma. El módulo se puede instalar individualmente o en composición, combinándolo con el resto de las plataformas de la colección Baia Parklet.

## BAIA - PARKLET D

Designer:	Nichetto Studio
Dimensions/Dimensiones:	4800x2000 mm H 1180 mm
Materials/Materiales:	CLS o WPC Ultra + Powder coated steel + HPC + HPL CLS o WPC Ultra + Acero pintado + HPC + HPL
Finishes/Acabados:	HPC Velluto - Natural smooth HPC Velluto - Liso natural
Fixing/Fijación:	Freestanding with pedestals or Installation with threaded bars Apoyo con pies o Cimentación con varillas roscadas

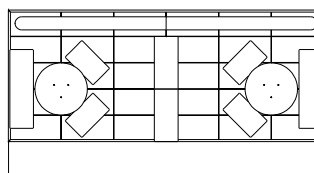
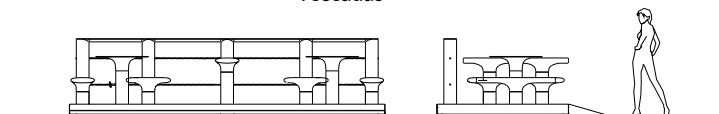



## BAIA - PARKLET E

Designer:	Nichetto Studio
Dimensions/Dimensiones:	4800x2000 mm H 1180 mm
Materials/Materiales:	CLS o WPC Ultra + Powder coated steel + HPC + HPL CLS o WPC Ultra + Acero pintado + HPC + HPL
Finishes/Acabados:	HPC Velluto - Natural smooth HPC Velluto - Liso natural
Fixing/Fijación:	Freestanding with pedestals or Installation with threaded bars Apoyo con pies o Cimentación con varillas roscadas

Parklet module composed of a platform with a decorative steel band, composed of a steel frame with flooring in concrete plates or slats in WPC Plus (Wood Polymer Composite) and a parapet with supporting structure in steel tube, equipped with glass panel or stainless steel ropes, arranged horizontally, with upper element in HPL (High Pressure Laminate). The platform accommodates two compositions, both composed of four single benches without backrest with table. The benches are composed of a seat in HPC (High Performance Concrete) and a central steel support. The tables are composed of a steel base and a circular top in HPL (High Pressure Laminate) that stands on a support in HPC (High Performance Concrete). The two compositions are separated by a planter composed of a steel sheet structure elevated by supports and placed in the center of the platform. The module can be installed individually or in composition with the other platforms of the Baia Parklet collection.

Módulo parklet formado por una plataforma con un listón decorativo de acero, compuesto por una estructura de acero con el suelo en losas de hormigón o lamas en WPC Plus y un parapeto con estructura portante en tubo de acero, equipado con un panel de vidrio o alambre de acero inoxidable, dispuesto horizontalmente, con elemento superior en HPL (High Pressure Laminate).

La plataforma alberga dos composiciones, ambas formadas por cuatro asientos monoplaza sin respaldo, con mesa. Los asientos están hechos de HPC (High Performance Concrete) y un soporte central de acero. Las mesas constan de una base de acero y una superficie circular en HPL (High Pressure Laminate) que se apoya sobre un soporte en HPC (High Performance Concrete). Las dos composiciones están separadas por una jardinera, compuesta de una estructura de chapa de acero elevada por soportes, posicionada en el centro de la plataforma. El módulo se puede instalar individualmente o en composición, combinándolo con el resto de las plataformas de la colección Baia Parklet.

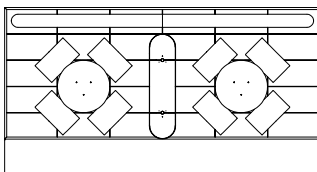
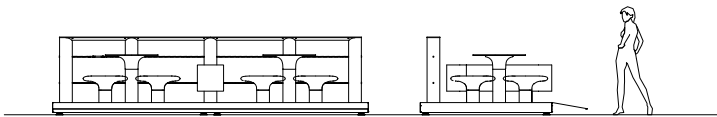



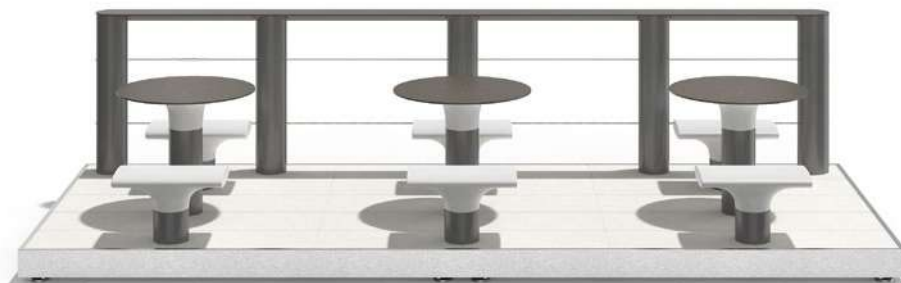

Parklet module composed of a platform with a decorative steel band, composed of a steel frame with flooring in concrete plates or slats in WPC Plus (Wood Polymer Composite) and a parapet with supporting structure in steel tube, equipped with glass panel or stainless steel ropes, arranged horizontally, with upper element in HPL (High Pressure Laminate). The platform accommodates three compositions, composed of two single benches without backrest with table. The benches are composed of a seat in HPC (High Performance Concrete) and a central steel support. The tables are composed of a steel base and a circular top in HPL (High Pressure Laminate) that stands on a support in HPC (High Performance Concrete). The module can be installed individually or in composition with the other platforms of the Baia Parklet collection.

Módulo parklet formado por una plataforma con un listón decorativo de acero, compuesto por una estructura de acero con el suelo en losas de hormigón o laminas de WPC Plus y un parapeto con estructura portante en tubo de acero, equipado con un panel de vidrio o alambre de acero inoxidable, dispuesto horizontalmente, con elemento superior en HPL (High Pressure Laminate).

La plataforma alberga tres composiciones, ambas formadas por dos asientos monoplaza sin respaldo, con mesa. Los asientos se componen de un asiento en HPC (High Performance Concrete) y de un soporte central de acero. Las mesas constan de una base de acero y una superficie circular en HPL (High Pressure Laminate) que se apoya sobre un soporte en HPC (High Performance Concrete). El módulo se puede instalar individualmente o en composición, combinándolo con el resto de las plataformas de la colección Baia Parklet.

## BAIA - PARKLET F

Designer:	Nichetto Studio
Dimensions/Dimensiones:	4800x2000 mm H 1180 mm
Materials/Materiales:	CLS o WPC Ultra + Powder coated steel + HPC + HPL CLS o WPC Ultra + Acero pintado + HPC + HPL
Finishes/Acabados:	HPC Velluto - Natural smooth HPC Velluto - Liso natural
Fixing/Fijación:	Freestanding with pedestals or Installation with threaded bars Apoyo con pies o Cimentación con varillas roscadas

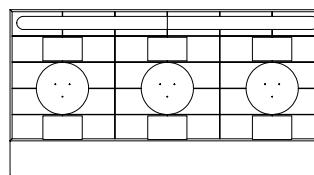
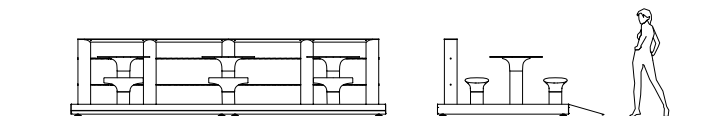





## BAIA - PARKLET G

Designer:	Nichetto Studio
Dimensions/Dimensiones:	4800x2000 mm H 1180 mm
Materials/Materiales:	CLS o WPC Ultra + Powder coated steel + HPC + HPL CLS o WPC Ultra + Acero pintado + HPC + HPL
Finishes/Acabados:	HPC Velluto - Natural smooth HPC Velluto - Liso natural
Fixing/Fijación:	Freestanding with pedestals or Installation with threaded bars Apoyo con pies o Cimentación con varillas roscadas

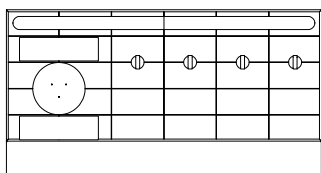
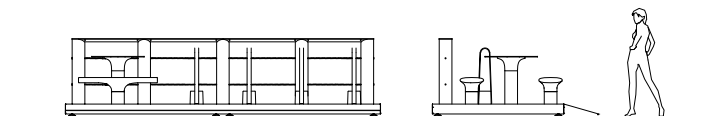

Parklet module composed of a platform with a decorative steel band, composed of a steel frame with flooring in concrete plates or slats in WPC Plus (Wood Polymer Composite) and a parapet with supporting structure in steel tube, equipped with glass panel or stainless steel ropes, arranged horizontally, with upper element in HPL (High Pressure Laminate). The platform accommodates one composition, composed of two benches without backrest with table and four bike racks. The benches are composed of a seat in HPC (High Performance Concrete) and a central steel support. The tables are composed of a steel base and a circular top in HPL (High Pressure Laminate) that stands on a support in HPC (High Performance Concrete). The bike racks are made of steel with a base in HPC (High Performance Concrete). The module can be installed individually or in composition with the other platforms of the Baia Parklet collection.

Módulo parklet formado por una plataforma con un listón decorativo de acero, compuesto por una estructura de acero con el suelo en losas de hormigón o laminas de WPC Plus y un parapeto con estructura portante en tubo de acero, equipado con un panel de vidrio o alambre de acero inoxidable, dispuesto horizontalmente, con elemento superior en HPL (High Pressure Laminate).

La plataforma alberga una composición formada por dos asientos sin respaldo, con mesa y cuatro aparcabicicletas. Los asientos se componen de un asiento en HPC (High Performance Concrete) y de un soporte central de acero. La mesa consta de una base de acero y una superficie circular en HPL (High Pressure Laminate) que se apoya sobre un soporte en HPC (High Performance Concrete). El aparcabicicletas está realizado en acero con una base en HPC (High Performance Concrete). El módulo se puede instalar individualmente o en composición, combinándolo con el resto de las plataformas de la colección Baia Parklet.



Parklet module composed of a platform with a decorative steel band, composed of a steel frame with flooring in concrete plates or slats in WPC Plus (Wood Polymer Composite) and a parapet with supporting structure in steel tube, equipped with glass panel or stainless steel ropes, arranged horizontally, with upper element in HPL (High Pressure Laminate). The platform accommodates two compositions, both composed of two curved benches without backrest with table, equipped with cover. The benches are composed of a seat in HPC (High Performance Concrete) and a central steel support. The tables are composed of a steel base and a circular top in HPL (High Pressure Laminate) that stands on a support in HPC (High Performance Concrete). The cover is composed of a steel support with opaline methacrylate upper element predisposed for LED lighting.

The two compositions are separated by a planter composed of a steel sheet structure elevated by supports and placed in the center of the platform.

The module can be installed individually or in composition with the other platforms of the Baia Parklet collection.

Módulo parklet formado por una plataforma con un listón decorativo de acero, compuesto por una estructura de acero con el suelo en losas de hormigón o lamina de WPC Plus y un parapeto con estructura portante en tubo de acero, equipado con un panel de vidrio o alambre de acero inoxidable, dispuesto horizontalmente, con elemento superior en HPL (High Pressure Laminate).

La plataforma alberga dos composiciones, ambas formadas por dos asientos curvos sin respaldo, con mesa dotado de cobertura. Los asientos se componen de un asiento en HPC (High Performance Concrete) y de un soporte central de acero. Las mesas constan de una base de acero y una superficie circular en HPL (High Pressure Laminate) que se apoya sobre un soporte en HPC (High Performance Concrete). La cubierta está formada por un soporte de acero con un elemento superior en metacrilato opal, diseñado para albergar la iluminación LED. Las dos composiciones están separadas por una jardinera, compuesta de una estructura de chapa de acero elevada por soportes, posicionada en el centro de la plataforma. El módulo se puede instalar individualmente o en composición, combinándolo con el resto de las plataformas de la colección Baia Parklet.

## BAIA - PARKLET H

Designer:	Nichetto Studio
Dimensions/Dimensiones:	4800x2000 mm H 2900 mm
Materials/Materiales:	CLS o WPC Ultra + Powder coated steel + HPC + HPL CLS o WPC Ultra + Acero pintado + HPC + HPL
Finishes/Acabados:	HPC Velluto - Natural smooth HPC Velluto - Liso natural
Fixing/Fijación:	Freestanding with pedestals or Installation with threaded bars Apoyo con pies o Cimentación con varillas roscadas

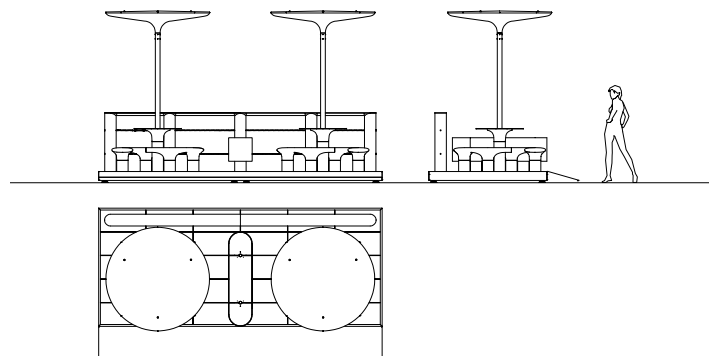

BAIA - PARKLET

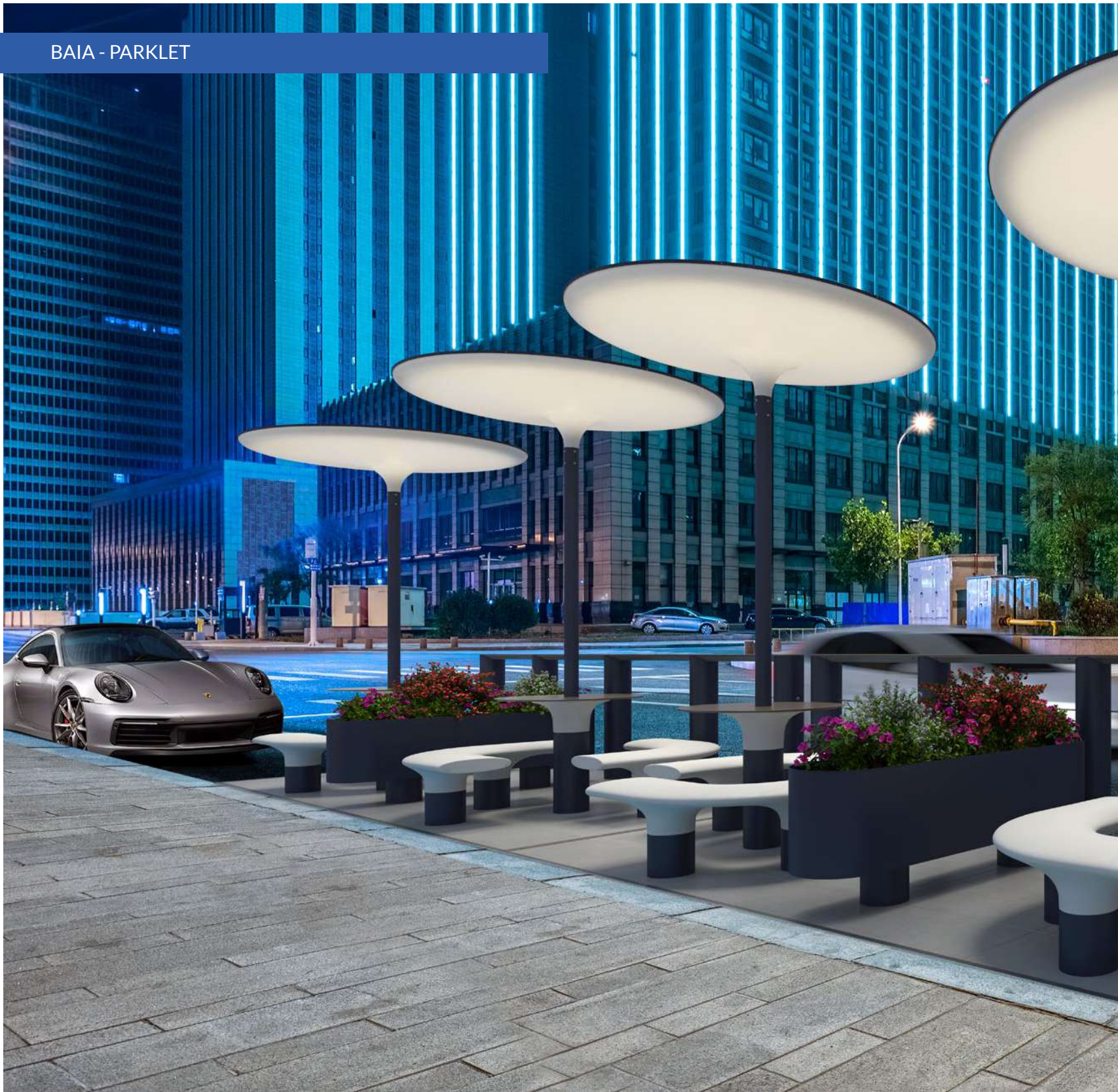







BAIA - PARKLET

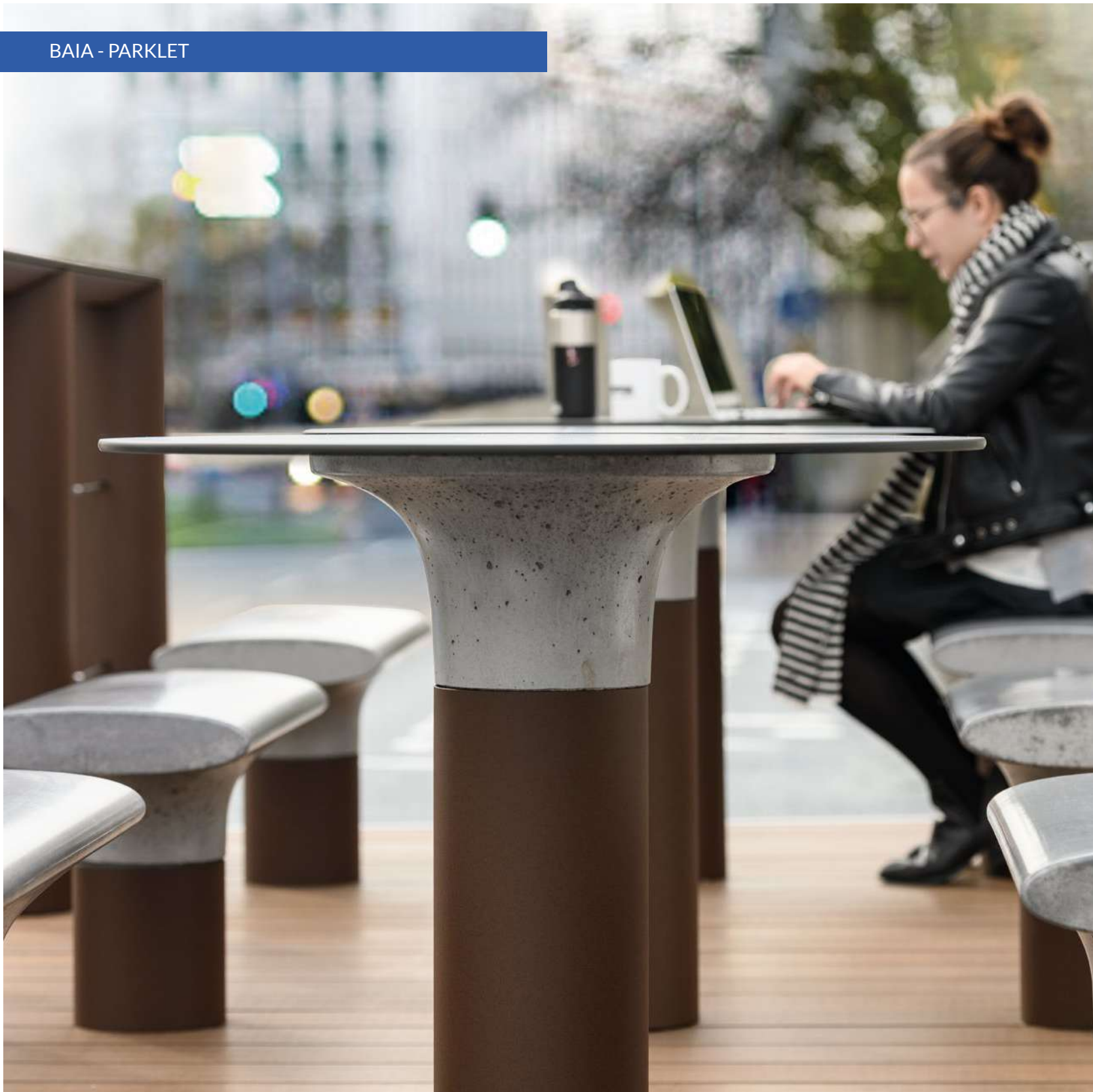





BAIA - ELEMENTS

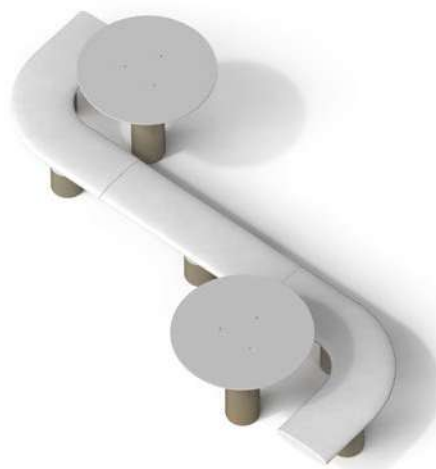
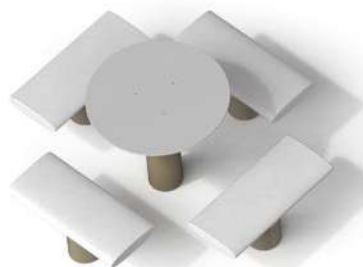
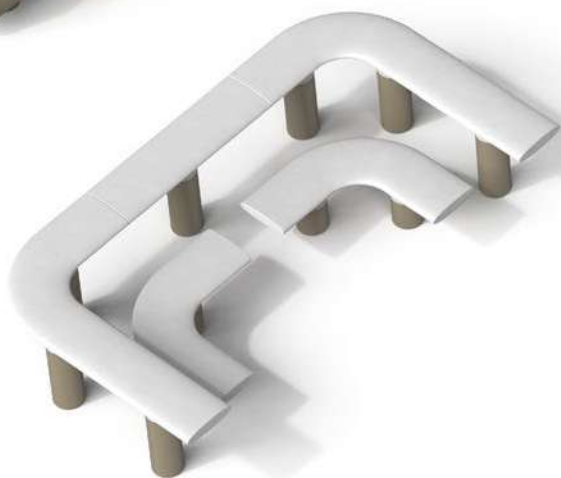



## Unconventional creativity

Baia is synonymous with aggregation, sociability and personal experiences.

To leave maximum free creativity, Baia Elements can be combined together to create meeting points, places to share aspirations and fully experience the city and its spaces.



## Creatividad fuera de todo esquema

Baia es sinónimo de agregación, de sociabilidad, de experiencias a la medida de la persona.

Para permitir la máxima libertad creativa, los Baia Elements se pueden combinar para crear puntos de encuentro, lugares donde compartir aspiraciones y vivir plenamente la ciudad y sus espacios.







BAIA - FLOWER



BAIA - UMBRELLA



BAIA - LOW TABLE



BAIA - HIGH TABLE



BAIA - BIKE

## BAIA - ELEMENTS

Designer:	Nichetto Studio		
Dimensions and weight Dimensiones y peso:	BAIA - FLOWER 1600x400 mm H 575 mm	71 kg	
	BAIA - UMBRELLA Ø 1760 mm H 2720 mm	118   122 kg	
	BAIA - TABLE Ø 790 mm H 1100 mm h 755 mm	44 kg 40 kg	
	BAIA - BIKE 205x200 mm H 860 mm	21 kg	
Materials/Materiales:	Powder coated steel + HPC + HPL Acero pintado + HPC + HPL		
Finishes/Acabados:	HPC Velluto - Natural smooth HPC Velluto - Liso natural		
Fixing/Fijación:	Pre-drilled for anchors or Below ground installation Predisposición para tacos o Cimentación		
Accessories/Accesorios:	LED lighting (Baia - Umbrella) Iluminación LED (Baia - Umbrella)		

Baia collection consists of different elements. The linear or curved benches, available in two different heights, are composed of a seat in HPC (High Performance Concrete) and a central steel support. The tables, available in two heights, are composed of a steel base and a circular top in HPL (High Pressure Laminate) that stands on a support in HPC (High Performance Concrete); they can be simple or with a cover made of a steel support with opaline methacrylate upper element. The planter is composed of a steel sheet structure elevated by supports. The bike rack is made of steel with a base in HPC (High Performance Concrete). All the elements are to be fixed to the ground by counterplates, pre-drilled for anchors or for below ground installation.

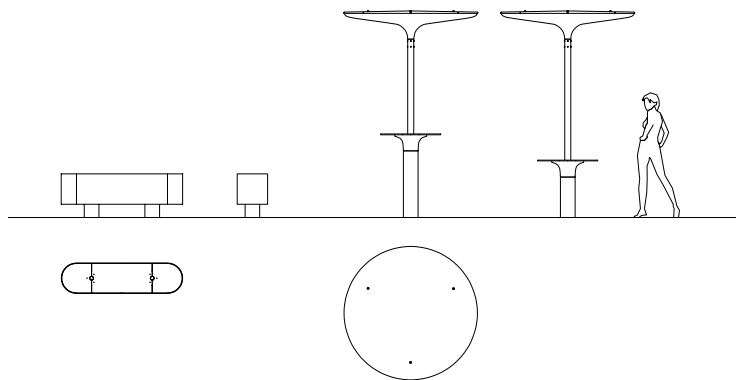



BAIA - HIGH SEAT S

BAIA - LOW SEAT S

BAIA - LOW SEAT L

BAIA - ANGLE L

BAIA - ANGLE H

La colección Baia se compone de diferentes elementos. Los asientos, lineales o curvos y disponibles en dos alturas diferentes, están compuestos por un asiento en HPC (High Performance Concrete) y un soporte central de acero. Las mesas, disponibles en dos alturas, constan de una base de acero y una superficie circular en HPL (High Pressure Laminate) que se apoya sobre un soporte en HPC (High Performance Concrete); las mesas pueden ser sencillas o con una cubierta formada por un soporte de acero con un elemento superior en metacrilato opal. La jardinera está compuesta por una estructura de chapa de acero elevada por soportes. El aparcabicicletas está realizado en acero con una base en HPC (High Performance Concrete). Todos los elementos deben ser fijados al suelo mediante contraplacas, dotadas de predisposición para anclajes o por cementación.

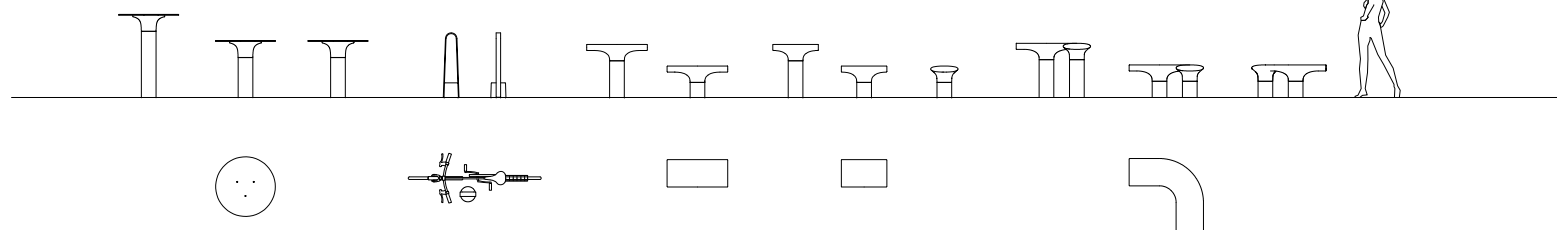
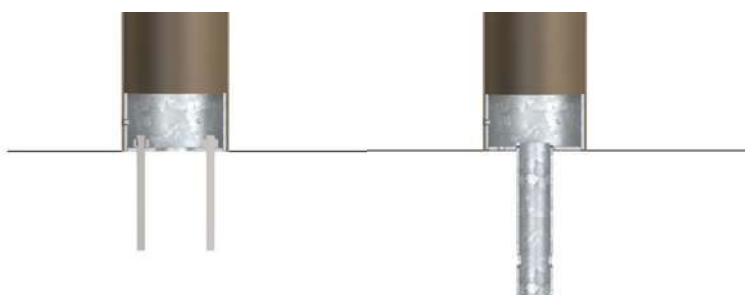

## BAIA - ELEMENTS

Designer:	Nichetto Studio
Dimensions and weight Dimensiones y peso:	<p><b>BAIA - SEAT S</b> 600x360 mm H 710 mm h 420 mm 60 55 kg</p> <p><b>BAIA - SEAT L</b> 800x360 mm H 710 mm h 420 mm 71 67 kg</p> <p><b>BAIA - ANGLE</b> 980x980 mm H 710 mm h 420 mm 130 122 kg</p>
Materials/Materiales:	Powder coated steel + HPC + HPL Acero pintado + HPC + HPL
Finishes/Acabados:	HPC Velluto - Natural smooth HPC Velluto - Liso natural
Fixing/Fijación:	Pre-drilled for anchors or Below ground installation Predisposición para tacos o Cementación



BAIA - ELEMENTS



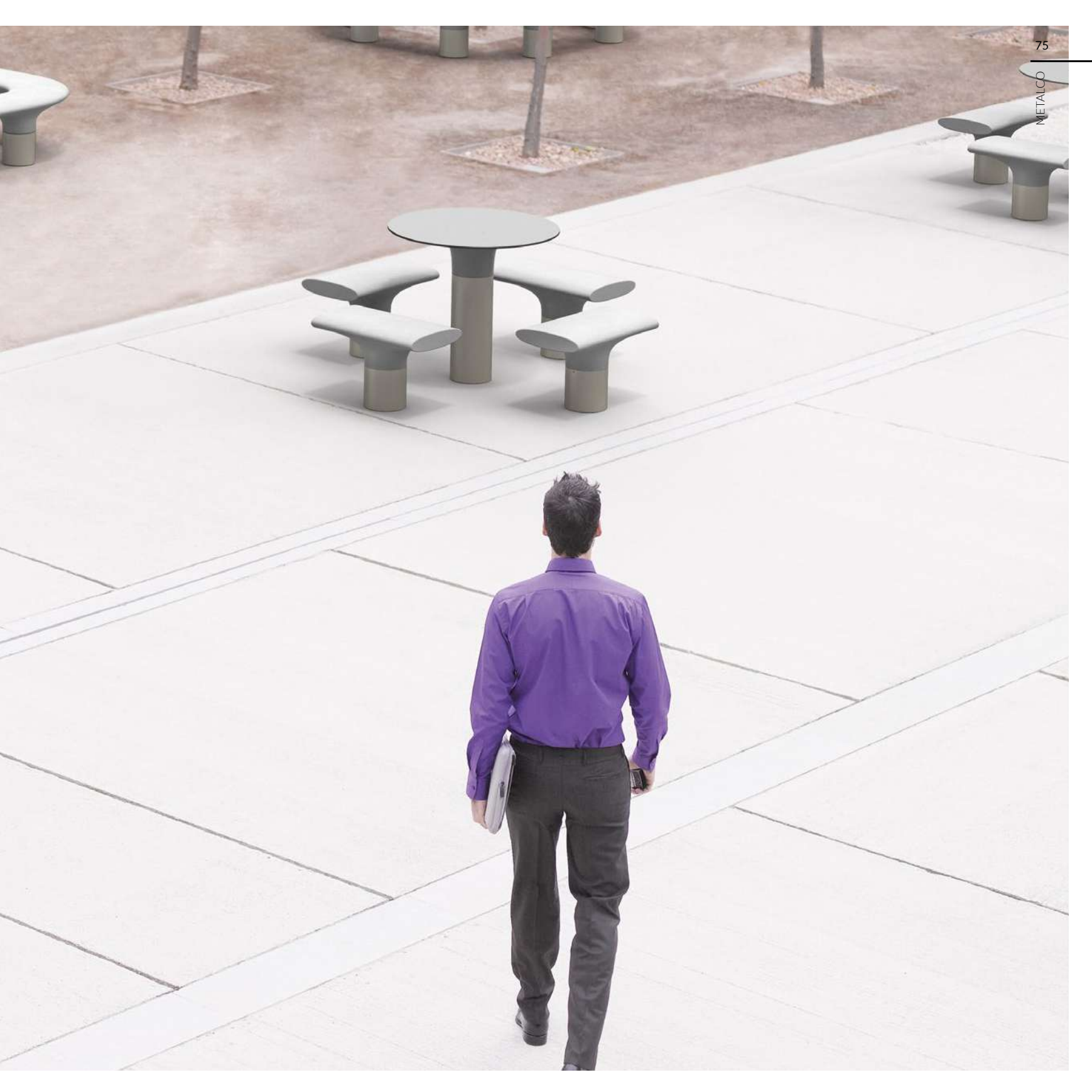

**BELANDSCAPE**  
**MASSIMO TASCA**  
**RAFFAELE LAZZARI**  
**MATTIA LI POMI**  
**PIO & TITO TOSO**

---



# VITAUROBANA: SOCIAL DESIGN STORIES

Vitaurbana:  
narraciones de  
diseño social













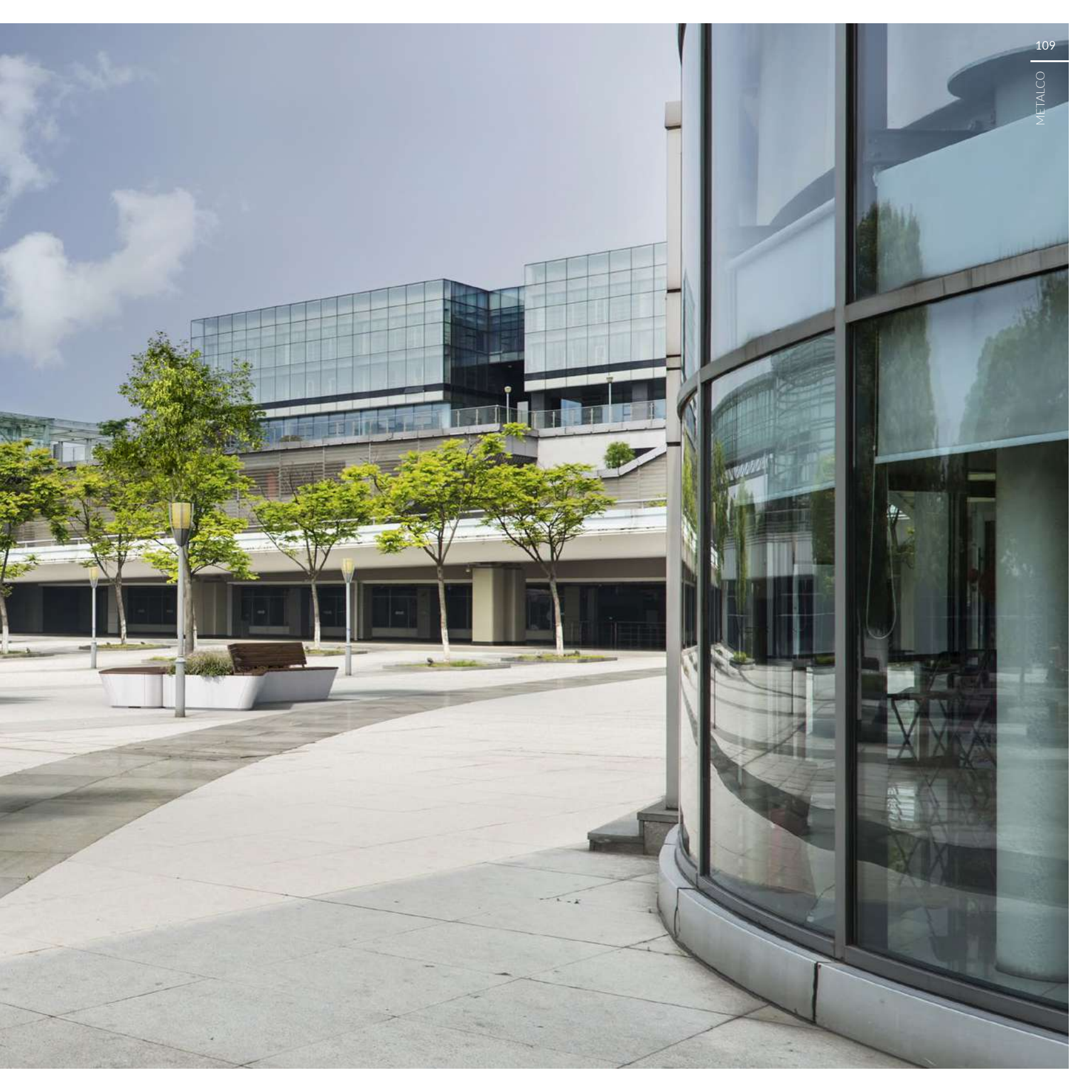





EH



EH + S

## CITY OF SION EH | EH+S

Designer:	Belandscape		
Dimensions and weight Dimensiones y peso:	<b>EH</b>		
	3990x1570 mm h 550 mm	Hardwood   Madera dura	433 kg
		Larch   Alerce	422 kg
	<b>EH + S</b>		
	3990x1570 mm H 955 mm h 550 mm	Hardwood   Madera dura	471 kg
		Larch   Alerce	451 kg
Materials/Materiales:	Powder coated steel + Hardwood or Larch Acero pintado + Madera dura o Alerce		
Fixing/Fijación:	Freestanding Apoyo		

Modular concave planters made of sheet steel and equipped with wooden seat. Two models, with or without backrest, are available. They can be installed in composition with all the other elements of the City of Sion collection.

Jardineras modulares realizadas en chapa de acero, de forma cóncava y equipado con asiento de madera. Disponibles en dos modelos: con y sin respaldo. Se pueden instalar en composición, combinándolos con los demás elementos de la colección City of Sion.

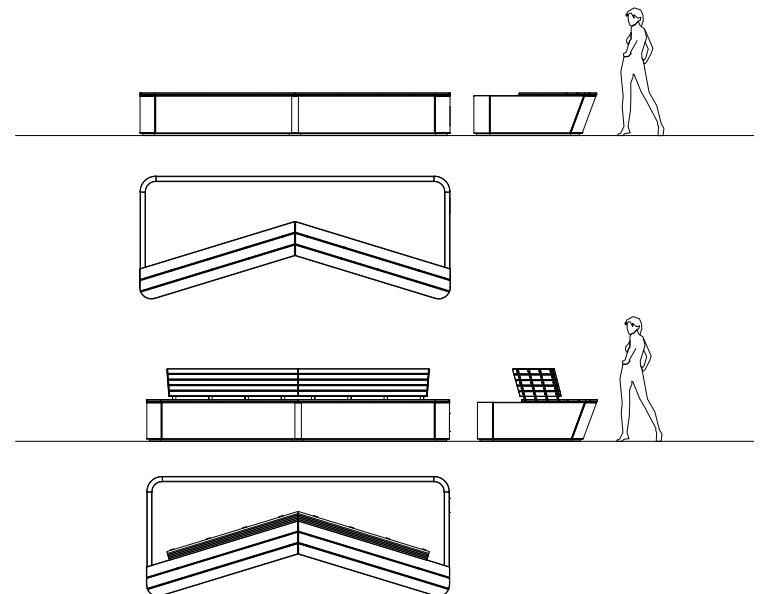



DH



DH + S

Modular convex planters made of sheet steel and equipped with wooden seat. They can be installed in composition with all the other elements of the City of Sion collection.

Jardineras modulares realizadas en chapa de acero, de forma convexa y equipado con asiento de madera. Disponibles en dos modelos: con o sin respaldo. Se pueden instalar en composición, combinándolos con los demás elementos de la colección City of Sion.

## CITY OF SION DH | DH+S

Designer:

Belandscape

Dimensions and weight  
Dimensiones y peso:

**DH**  
3990x1570 mm H 550 mm  
Hardwood | Madera dura 418 kg  
Larch | Alerce 407 kg

**DH + S**  
3990x1570 mm H 955 mm h 550 mm  
Hardwood | Madera dura 456 kg  
Larch | Alerce 436 kg

Materials/Materiales:

Powder coated steel + Hardwood or Larch  
Acero pintado + Madera dura o Alerce

Fixing/Fijación:

Freestanding  
Apoyo

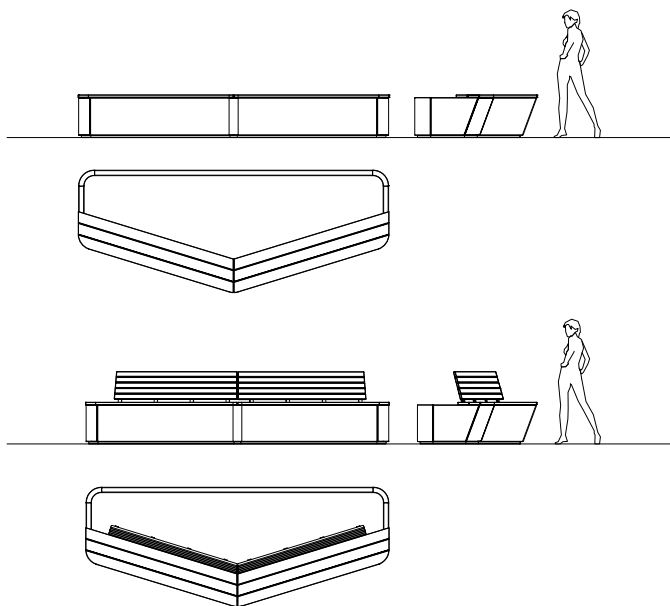



DW



EW

## CITY OF SION DW | EW

Designer:	Belandscape		
Dimensions and weight Dimensiones y peso:	DW		
	3990x1570 mm H 550 mm	Hardwood   Madera dura	423 kg
		Larch   Alerce	391 kg
	EW		
	3990x1570 mm H 550 mm	Hardwood   Madera dura	437 kg
		Larch   Alerce	407 kg
Materials/Materiales:	Powder coated steel + Hardwood or Larch Acero pintado + Madera dura o Alerce		
Fixing/Fijación:	Freestanding Apoyo		

Modular wooden seats composed of a supporting structure in steel sheet and equipped with central planter in steel. Available two models: one concave, the other convex. They can be installed in composition with all the other elements of the City of Sion collection.

Asientos modulares de madera con una estructura portante en chapa de acero y dotada de una jardinera central también en acero. Disponibles en dos modelos: uno cóncavo, el otro convexo. Se pueden instalar en composición, combinándolos con los demás elementos de la colección City of Sion.

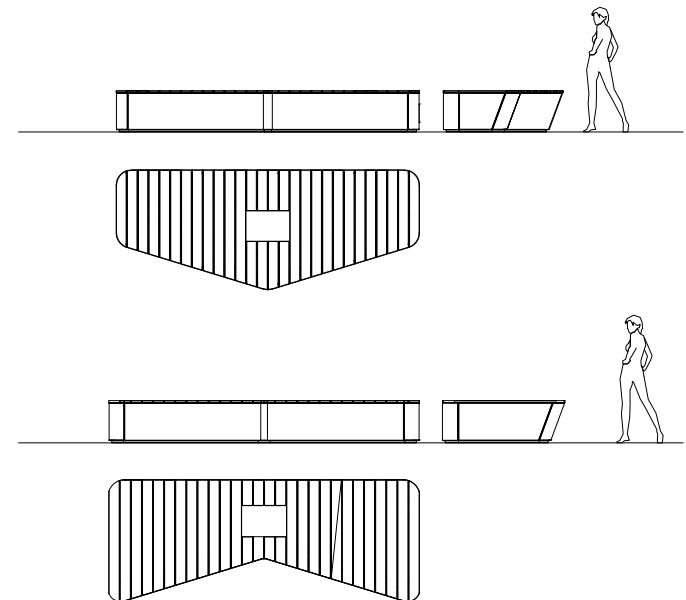





D



E

Modular planters made of sheet steel, available in two models: one concave, the other convex. They can be installed in composition with all the other elements of the City of Sion collection.

Jardineras modulares realizadas en chapa de acero, disponibles en dos modelos: uno cóncavo, el otro convexo. Se pueden instalar en composición, combinándoles con los demás elementos de la colección City of Sion.

## CITY OF SION D | E

Designer:	Belandscape		
Dimensions and weight	3990x1570 mm H 515 mm		
Dimensiones y peso:	D	323 kg	
	E	340 kg	
Materials/Materiales:	Powder coated steel Acero pintado		
Fixing/Fijación:	Freestanding Apoyo		

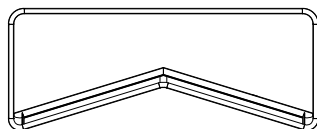
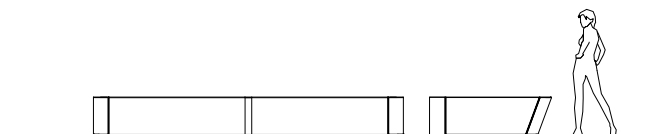
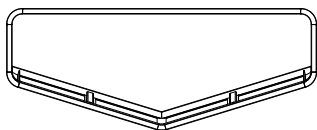

JARDIN









JARDIN





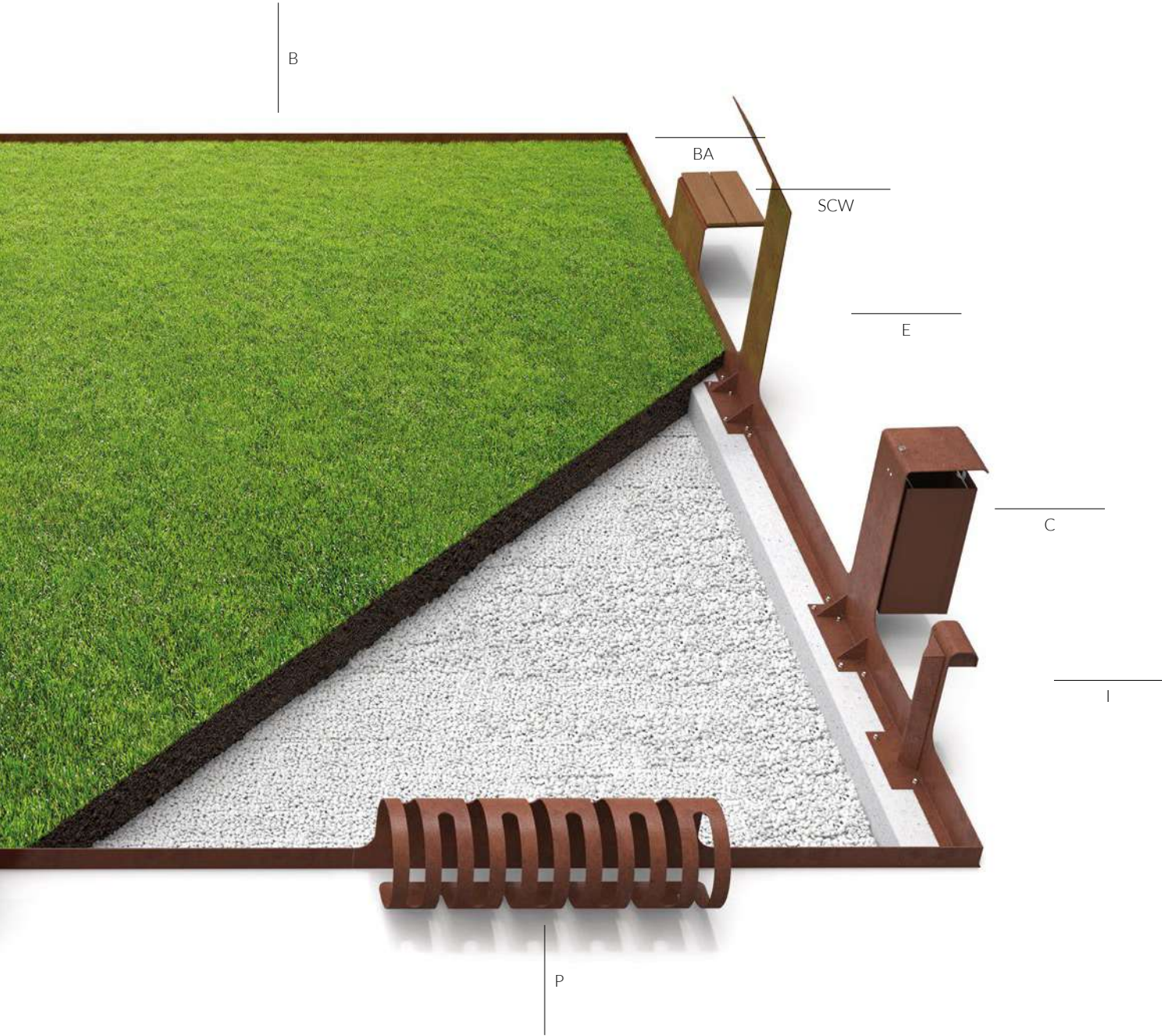



SC



SL

## JARDIN SC | SL

Designer:	Pio & Tito Toso
Dimensions and weight Dimensiones y peso:	<p>SC 740x495 mm H 405 mm (+ 100 mm) 25 kg</p> <p>SL 1980x495 mm H 405 mm (+ 100 mm) 74 kg</p>
Materials/Materiales:	Corten steel Acero Corten
Fixing/Fijación:	Pre-drilled for anchors Predisposición para tacos

Modules of the Jardín collection, which can be combined with the other elements of the collection to build a system to delimit green spaces, while integrating furniture elements. The SC and SL models are composed of a seat without backrest, obtained from a single shaped Corten steel sheet. The SC model is a single seat.

Módulos de la colección Jardín que pueden ser combinados con los otros elementos de la colección para construir un sistema, con elementos de decoración integrados, para delimitar los espacios verdes. Los modelos SC y SL están formados por un asiento sin respaldo, obtenido con una única hoja de chapa moldeada en acero Corten. El modelo SC es monoplaza.

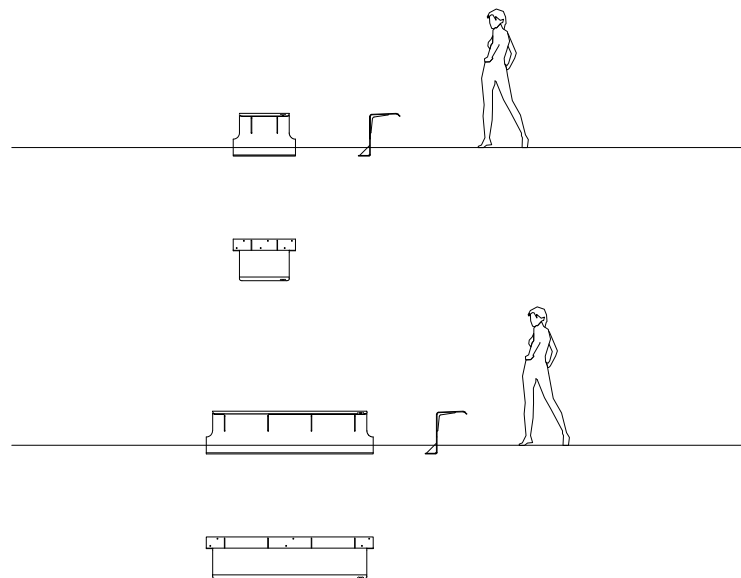



SCW



SLW

Modules of the Jardín collection, which can be combined with the other elements of the collection to build a system with integrated furniture elements, to delimit green spaces. The SCW and SLW models are composed of a seat without backrest, obtained from a single sheet of shaped Corten steel sheet, equipped with a plane in WPC (Wood Polymer Composite). The SCW model is single-seater.

Módulos de la colección Jardín que pueden ser combinados con los otros elementos de la colección para construir un sistema, con elementos de decoración integrados, para delimitar los espacios verdes. Los modelos SCW y SLW están formados por un asiento sin respaldo, obtenido con una única hoja de chapa moldeada en acero Corten, dotada de una superficie en WPC (Wood Polymer Composite). El modelo SCW es monoplaza.

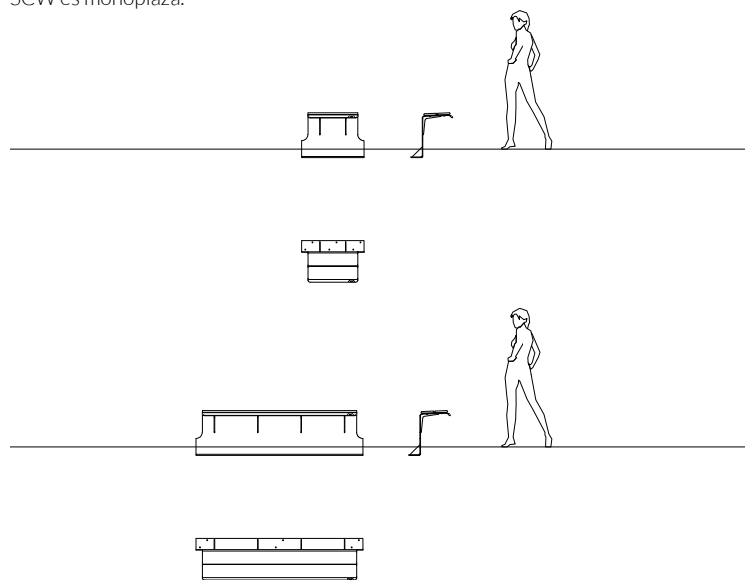

## JARDIN SCW | SLW

Designer:	Pio & Tito Toso
Dimensions and weight Dimensiones y peso:	<p><b>SCW</b> 740x495 mm H 430 mm (+ 100 mm) 32 kg</p> <p><b>SLW</b> 1980x495 mm H 430 mm (+ 100 mm) 90 kg</p>
Materials/Materiales:	<p>Corten steel + WPC Plus (Wood Polymer Composite) Acero Corten + WPC Plus (Wood Polymer Composite)</p>
Fixing/Fijación:	<p>Pre-drilled for anchors Predisposición para tacos</p>





BA



B

## JARDIN BA | B

Designer:	Pio & Tito Toso
Dimensions and weight Dimensiones y peso:	<p><b>BA</b> 1050x635 mm H 100 mm (+ 100 mm) 17 kg</p> <p><b>B</b> 1980x60 mm H 100 mm (+ 100 mm) 20 kg</p> <p>1480x60 mm H 100 mm (+ 100 mm) 15 kg</p> <p>980x60 mm H 100 mm (+ 100 mm) 10 kg</p>
Materials/Materiales:	Corten steel Acero Corten
Fixing/Fijación:	Pre-drilled for anchors Predisposición para tacos

Modules of the Jardín collection composed of Corten steel borders. Two versions are available: one linear (B) with three different lengths and one angular (BA). The modules can be combined with the other elements of the collection to delimit green areas.

Módulos de la colección Jardín formados por bordes en chapa de acero Corten que pueden ser combinados con los otros elementos de la colección para delimitar los espacios verdes. Disponibles en dos versiones: una lineal (B) con tres largos diferentes y una en ángulo (BA).

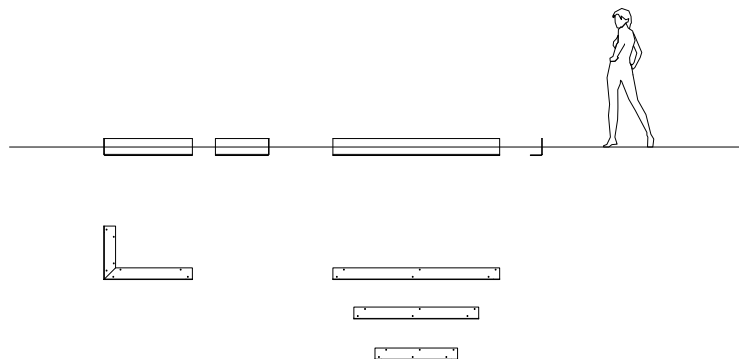



SA



SAW

Modules of the Jardín collection, that can be combined with the other elements of the collection to build a system to delimit green spaces, while integrating furniture elements. The SA and SAW models are composed of a corner structure that serves as a seat without backrest, obtained from a single shaped Corten steel sheet. The SAW model is equipped with a plane made of WPC (Wood Polymer Composite).

Módulos de la colección Jardín que pueden combinarse con los otros elementos de la colección para construir un sistema, con elementos de decoración integrados, para delimitar los espacios verdes. Los modelos SA y SAW están formados por una estructura a ángulo que hace de asiento sin respaldo, obtenido con una única hoja de chapa moldeada en acero Corten. El modelo SAW es dotado de una superficie en WPC (Wood Polymer Composite).

## JARDIN SA | SAW

Designer:	Pio & Tito Toso
Dimensions and weight Dimensiones y peso:	<p><b>SA</b> 1405x990 mm H 405 mm (+ 100 mm) 67 kg</p> <p><b>SAW</b> 1405X990 mm H 430 mm (+ 100 mm) 83 kg</p>
Materials/Materiales:	<p>Corten steel + WPC Plus (Wood Polymer Composite) Acero Corten + WPC Plus (Wood Polymer Composite)</p>
Fixing/Fijación:	<p>Pre-drilled for anchors Predisposición para tacos</p>

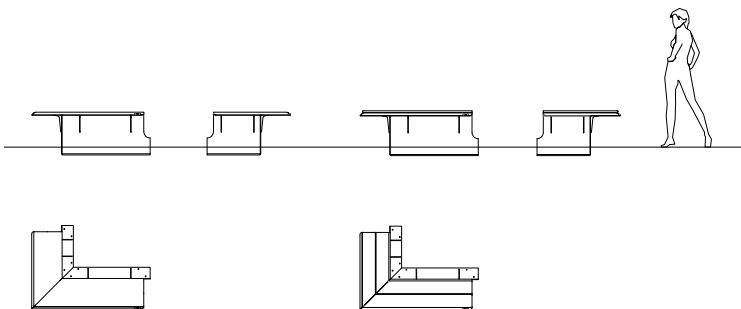



JARDIN









I



E

## JARDIN I | E

Designer:	Pio & Tito Toso
Dimensions and weight Dimensiones y peso:	<p>I 360x260 mm H 555 mm (+ 100 mm) 14 kg</p> <p>E 480x280 mm H 1625 mm (+ 100 mm) 28 kg</p>
Materials/Materiales:	Corten steel Acero Corten
Fixing/Fijación:	Pre-drilled for anchors Predisposición para tacos

Modules of the Jardín collection, that can be combined with the other elements of the collection to build a system to delimit green spaces, while integrating furniture elements. The I model is a Corten steel sheet path marker with LED lighting system. The E model is an information panel composed of a Corten steel structure with stainless steel plate, customizable with stickers, pre-spaced writing or serigraphy.

Módulos de la colección Jardín que pueden combinarse con los otros elementos de la colección para construir un sistema, con elementos de decoración integrados, para delimitar los espacios verdes. El modelo I es un iniciador de acceso en chapa de acero Corten con sistema de iluminación LED. El modelo E es un panel informativo dotado de una estructura de acero Corten con placa en acero inoxidable personalizable con adhesivos, letras pre-espaciadas o serigrafía.

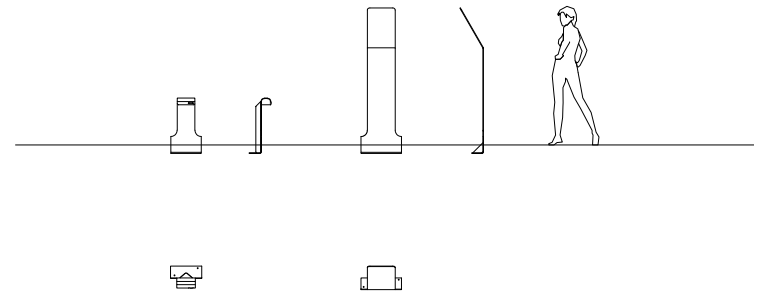





P



C

Modules of the Jardín collection, that can be combined with the other elements of the collection to build a system to delimit green spaces, while integrating furniture elements. The P model is a bike rack made of calendered Corten steel sheet. The C model is a square litter bin in Corten steel, equipped with rain cover and a drop-down opening container.

Módulos de la colección Jardín que pueden combinarse con otros elementos de la colección para construir un sistema, con elementos de decoración integrados, para delimitar los espacios verdes. El modelo P es un aparcabicicletas formado por una chapa de acero Corten calandrada. El modelo C es una papelera con base cuadrada en acero Corten, dotada de cobertura para la lluvia y de un contenedor abatible.

## JARDIN P | C

Designer:	Pio & Tito Toso
Dimensions and weight Dimensiones y peso:	<p><b>P</b> 1410x545 mm H 465 mm (+ 100 mm) 62 kg</p> <p><b>C</b> 480x495 mm H 925 mm (+ 100 mm) 33 kg</p>
Materials/Materiales:	Corten steel Acero Corten
Fixing/Fijación:	Pre-drilled for anchors Predisposición para tacos

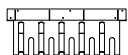
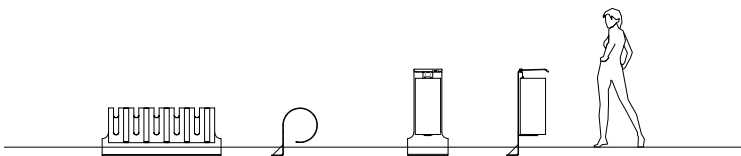



GRANDIFIORIERE

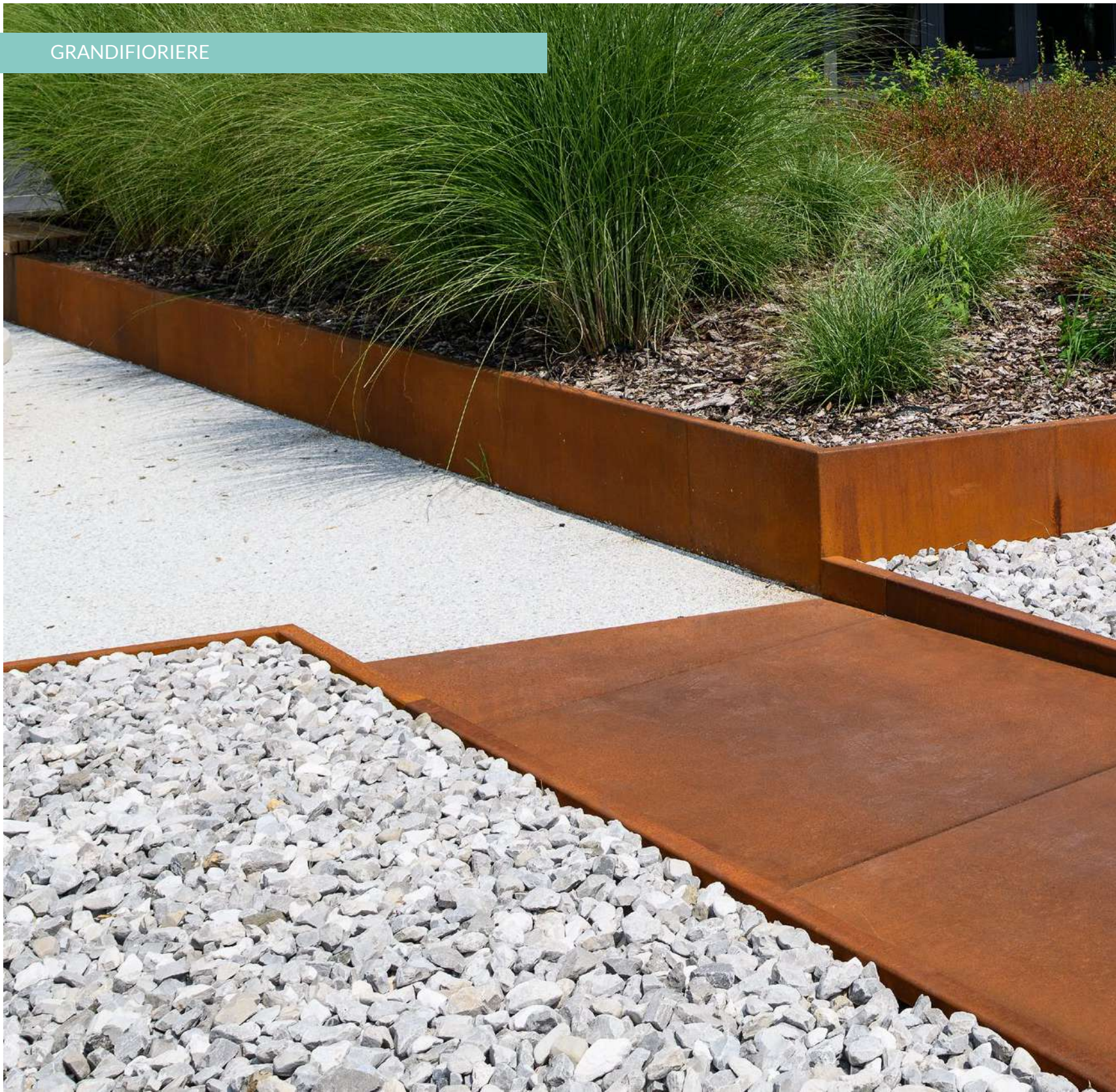







GRANDIFIORIERE











GSO



GSV

## GRANDIFIORIERE GSO | GSV

Designer:	Massimo Tasca
Dimensions and weight Dimensiones y peso:	GSO 950x445 mm H 385 mm (+ 100 mm) Hardwood   Madera dura 72 kg Larch   Alerce 65 kg
	GSV 950x445 mm H 385 mm (+ 100 mm) Hardwood   Madera dura 72 kg Larch   Alerce 65 kg
	1900x445 mm H 385 mm (+ 100 mm) Hardwood   Madera dura 127 kg Larch   Alerce 114 kg
Materials/Materiales:	Corten steel + Hardwood or Larch Acero Corten + Madera dura o Alerce
Fixing/Fijación:	Pre-drilled for anchors or Below ground installation Predisposición para tacos o Cimentación

Modular linear element of the Grandiforiere collection, composed of a Corten steel structure, with horizontal or transversal integrated wooden seat. It can be combined with the other modules of the collection, to build a soil containment system with integrated seats.

Elemento modular lineal de la colección Grandiforiere, con estructura en acero Corten y con la superficie del asiento de madera integrada, horizontal o transversal. Se puede combinar con los otros módulos de la colección, para construir un sistema de contención del terreno con asientos integrados.

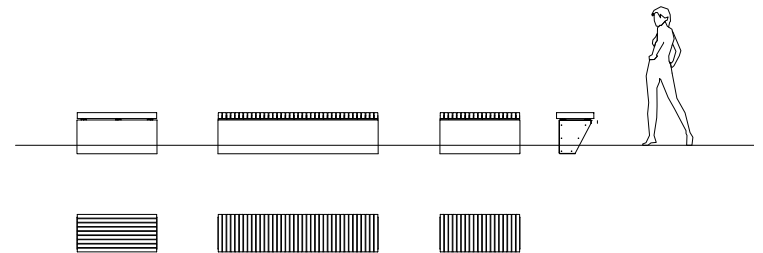



GSA1

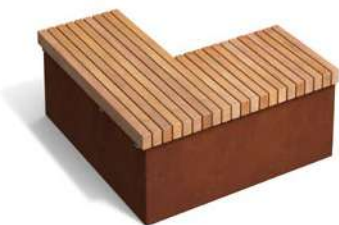

GSA2



Modular corner element of the Grandiforiere collection, composed of a Corten steel structure, with concave or convex integrated wooden seat. It can be combined with the other modules of the collection, to build a soil containment system with integrated seats.

Elemento modular, a forma de ángulo, de la colección Grandiforiere, con estructura en acero Corten y con la superficie del asiento de madera integrada, cóncava o convexa. Se puede combinar con los otros módulos de la colección, para construir un sistema de contención del terreno con asientos integrados.

## GRANDIFORIERE GSA1 | GSA2

Designer:	Massimo Tasca
Dimensions and weight Dimensiones y peso:	945x945 mm H 385 mm (+ 100 mm) Hardwood   Madera dura 114 kg Larch   Alerce 102 kg
Materials/Materiales:	Corten steel + Hardwood or Larch Acero Corten + Madera dura o Alerce
Fixing/Fijación:	Pre-drilled for anchors or Below ground installation Predisposición para tacos o Cimentación

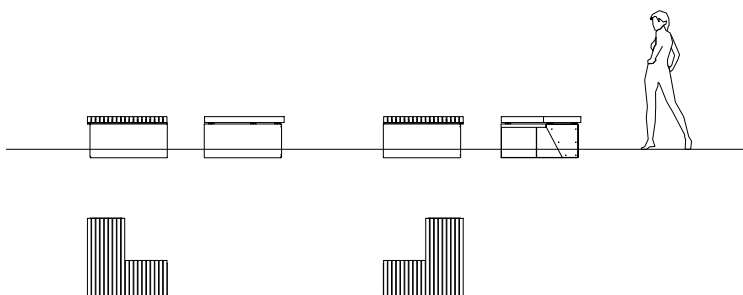





GSR

## GRANDIFIORIERE GSR

Designer:	Massimo Tasca
Dimensions and weight Dimensiones y peso:	1830x590 mm H 385 mm (+ 100 mm) Ri 1925 mm Re 2370 mm Hardwood   Madera dura 107 kg Larch   Alerce 97 kg
Materials/Materiales:	Corten steel + Hardwood or Larch Acero Corten + Madera dura o Alerce
Fixing/Fijación:	Pre-drilled for anchors or Below ground installation Predisposición para tacos o Cimentación

Modular circular element of the Grandiforiere collection, composed of a Corten steel structure, with integrated wooden seat. It can be combined with the other modules of the collection, to build a soil containment system with integrated seats.

Elemento modular circular de la colección Grandiforiere, con estructura en acero Corten y con la superficie del asiento de madera integrada. Se puede combinar con los otros módulos de la colección, para construir un sistema de contención del terreno con asientos integrados.

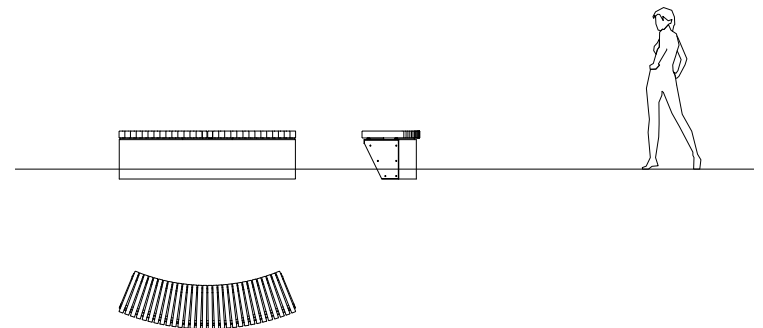



Modular linear element of the Grandiforiere collection, available in three heights and two lengths. It can be combined with the other modules of the collection, to build a soil containment system.

Elemento modular lineal de la colección Grandiforiere, disponible en tres alturas y en dos largos. Se puede combinar con los otros módulos de la colección, para construir un sistema de contención del terreno.

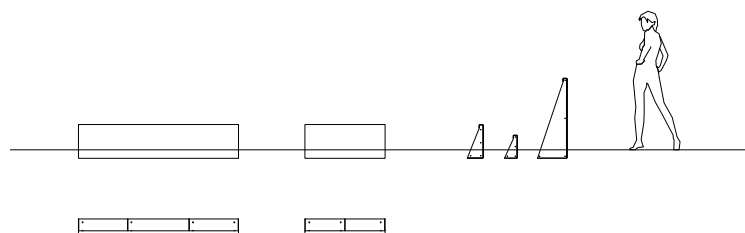

## GRANDIFIORIERE GBO | GBV

Designer:

Massimo Tasca

Dimensions and weight  
Dimensiones y peso:

**GBO**  
L 950 mm  
H 200 mm (+ 100 mm) P 150 mm 18 kg  
H 300 mm (+ 100 mm) P 190 mm 27 kg  
H 850 mm (+ 100 mm) P 350 mm 58 kg

**GBV**  
L 1900 mm  
H 200 mm (+ 100 mm) P 150 mm 39 kg  
H 300 mm (+ 100 mm) P 190 mm 45 kg  
H 850 mm (+ 100 mm) P 350 mm 105 kg

Materials/Materiales:

Corten steel  
Acero Corten

Fixing/Fijación:

Pre-drilled for anchors or Below ground installation  
Predisposición para tacos o Cimentación



## GRANDIFIORIERE GBA I | GBA E

Designer:	Massimo Tasca		
Dimensions and weight Dimensiones y peso:	GBA I		
	1055x1055 mm		
	H 200 mm (+ 100mm)		42 kg
	H 300 mm (+ 100mm)		56 kg
	H 850 mm (+ 100mm)		110kg
	GBA E		
	915x915 mm		
	H 200 mm (+ 100mm)		32 kg
	H 300 mm (+ 100mm)		46 kg
	H 850 mm (+ 100mm)		88 kg
Materials/Materiales:	Corten steel Acero Corten		
Fixing/Fijación:	Pre-drilled for anchors or Below ground installation Predisposición para tacos o Cimentación		

Modular corner element of the Grandiforiere collection, concave or convex, available in three heights. It can be combined with the other modules of the collection, to build a soil containment system with integrated seats.

Elemento modular, a forma de ángulo, de la colección Grandiforiere, cóncavo o convexo, disponible en tres alturas. Se puede combinar con los otros módulos de la colección, para construir un sistema de contención del terreno con asientos integrados.

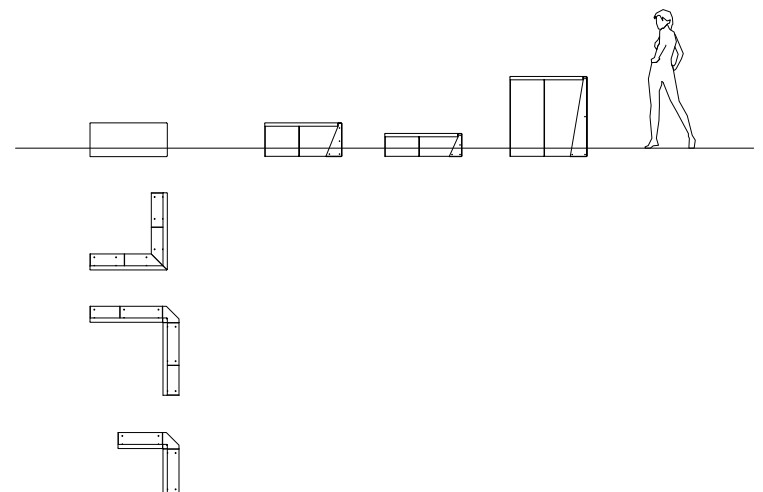





GBR



Modular circular element of the Grandiforiere collection, available in three heights. It can be combined with the other modules of the collection, to build a soil containment system.

Elemento modular circular de la colección Grandiforiere, disponible en tres alturas. Se puede combinar con los otros módulos de la colección, para construir un sistema de contención del terreno.

## GRANDIFIORIERE GBR

Designer:	Massimo Tasca
Dimensions and weight Dimensiones y peso:	1830x360 mm Re 2345 mm Ri 2295 mm H 200 mm (+ 100 mm) 33 kg H 300 mm (+ 100 mm) 44 kg H 850 mm (+ 100 mm) 100 kg
Materials/Materiales:	Corten steel Acero Corten
Fixing/Fijación:	Pre-drilled for anchors or Below ground installation Predisposición para tacos o Cimentación

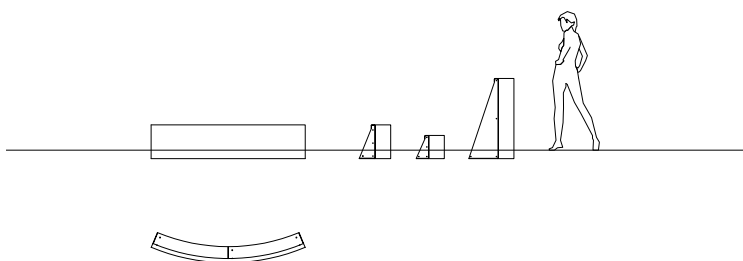

GRANDIFIORIERE

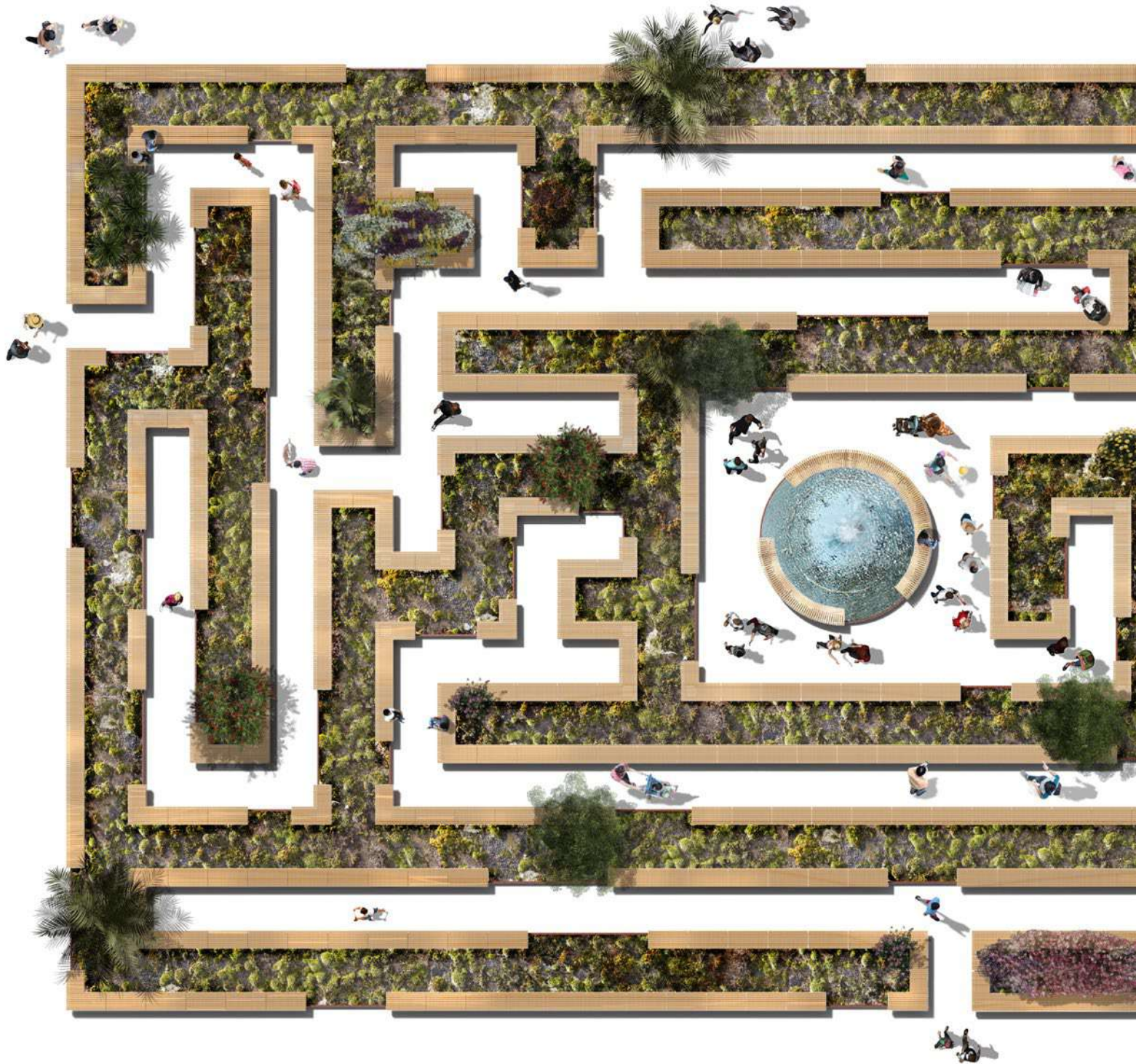







ALTEREGO







1D



4V

## ALTEREGO 1D | 4V

Designer:	Massimo Tasca + Mattia Li Pomi	
Dimensions and weight	1D	
Dimensiones y peso:	600x600 mm H 440 mm	310 kg
	4V	
	2300x600 mm H 440 mm	970 kg
Materials/Materiales:	HPC (High Performance Concrete)	
Finishes/Acabados:	Velluto - Natural smooth Velluto - Liso natural	
Fixing/Fijación:	Freestanding Apoyo	
Accessories/Accesorios:	LED lighting Iluminación LED	

Modules of the Alterego collection composed of monolithic seats made of HPC (High Performance Concrete), partially emptied inside and available in two sizes. They can be installed individually or in compositions.

Módulos de la colección Alterego constituidos por asientos monolíticos en HPC (High Performance Concrete), aligerados internamente, disponibles en dos tamaños. Se pueden instalar individualmente o en composición.

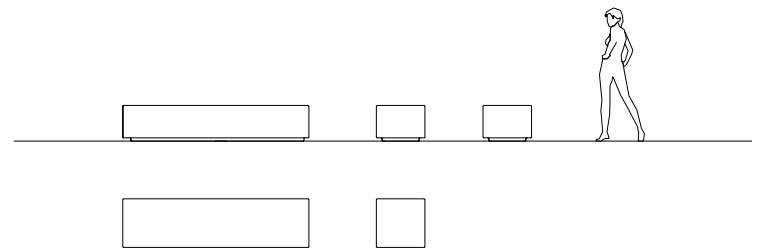





4V + SP 750



4V + SP 1750

Modules of the Alterego collection composed of monolithic seats made of HPC (High Performance Concrete), partially emptied inside. The 4V+SP model is equipped with wooden seat, without backrest, available in two sizes. Each model can be installed individually or in compositions.

Módulos de la colección Alterego constituidos por asientos monolíticos en HPC (High Performance Concrete), aligerados internamente, disponibles en dos versiones. El modelo 4V + SP tiene un elemento de madera que actúa como asiento disponible en dos versiones con tamaños diferentes, ambas sin respaldo. Se pueden instalar individualmente o en composición.

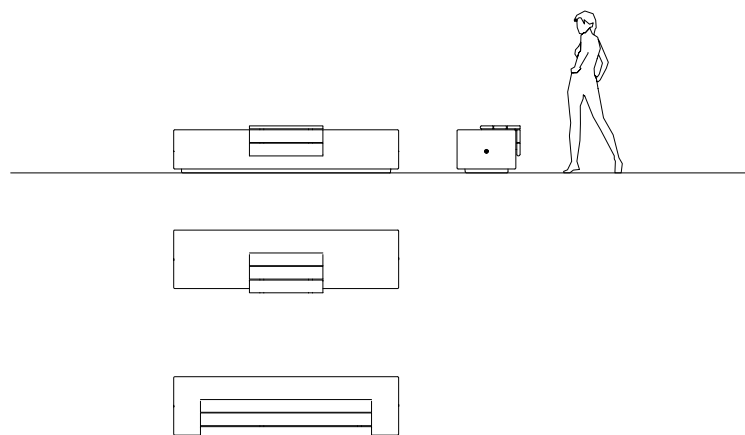

## ALTEREGO 4V + SP 750 | 4V + SP 1750

Designer:	Massimo Tasca + Mattia Li Pomi				
Dimensions and weight Dimensiones y peso:	<table> <tr> <td>4V + SP 750 2300x640 mm H 480 mm</td> <td>987 kg</td> </tr> <tr> <td>4V + SP 1750 2300x640 mm H 480 mm</td> <td>1007 kg</td> </tr> </table>	4V + SP 750 2300x640 mm H 480 mm	987 kg	4V + SP 1750 2300x640 mm H 480 mm	1007 kg
4V + SP 750 2300x640 mm H 480 mm	987 kg				
4V + SP 1750 2300x640 mm H 480 mm	1007 kg				
Materials/Materiales:	HPC (High Performance Concrete) + Hardwood HPC (High Performance Concrete) + Madera dura				
Finishes/Acabados:	HPC Velluto - Natural smooth HPC Velluto - Liso natural				
Fixing/Fijación:	Freestanding Apoyo				
Accessories/Accesorios:	LED lighting Iluminación LED				



4V + SS 750



4V + SS 1750

## ALTEREGO 4V + SS 750 | 4V + SS 1750

Designer:	Massimo Tasca + Mattia Li Pomi	
Dimensions and weight Dimensiones y peso:	4V + SS 750 2300x640 mm H 880 mm	996 kg
	4V + SS 1750 2300x640 mm H 880 mm	1029 kg
Materials/Materiales:	HPC (High Performance Concrete) + Hardwood HPC (High Performance Concrete) + Madera dura	
Finishes/Acabados:	HPC Velluto - Natural smooth HPC Velluto - Liso natural	
Fixing/Fijación:	Freestanding Apoyo	
Accessories/Accesorios:	LED lighting Iluminación LED	

Modules of the Alterego collection composed of seats made of HPC (High Performance Concrete), partially emptied inside. The 4V+SS model is equipped with a wooden seat, with backrest, available in two sizes. They can be installed individually or in compositions.

Módulos de la colección Alterego constituidos de asientos en HPC (High Performance Concrete), aligerados internamente. El modelo 4V + SS tiene un elemento de madera que actúa como un asiento, disponible en dos versiones con tamaños diferentes, ambas con respaldo. Se pueden instalar individualmente o en composición.

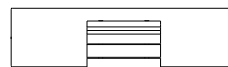
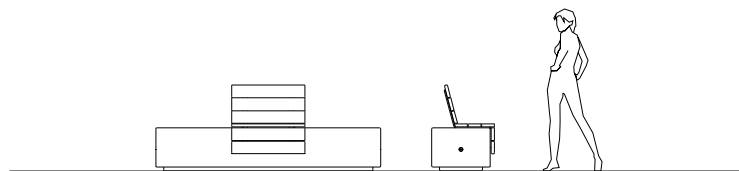



4V + DE



4V + TA

Modules of the Alterego collection made of HPC (High Performance Concrete), partially emptied inside, available in two versions. The 4V+DE model is equipped with single wooden seat with backrest and armrests. The 4V+TA model is equipped with a wooden table. They can be installed individually or in compositions.

Módulos de la colección Alterego constituidos en HPC (High Performance Concrete), aligerados internamente, disponibles en dos versiones. El modelo 4V + DE tiene un elemento de madera que actúa como un asiento monoplaza con respaldo y apoyabrazos. El modelo 4V + TA está equipado con una mesa de madera. Se pueden instalar individualmente o en composición.

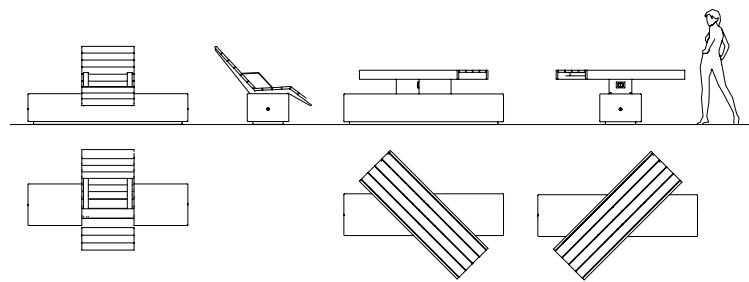

## ALTEREGO 4V + DE | 4V + TA

Designer:	Massimo Tasca + Mattia Li Pomi
Dimensions and weight Dimensiones y peso:	<p><b>4V + DE</b> 2300x1420 mm H 1125 mm 1018 kg</p> <p><b>4V + TA</b> 2300x1850 mm H 782 mm 1049 kg</p>
Materials/Materiales:	HPC (High Performance Concrete) + Powder coated steel or Corten steel + Hardwood HPC (High Performance Concrete) + Acero pintado o Acero Corten + Madera dura
Finishes/Acabados:	HPC Velluto - Natural smooth HPC Velluto - Liso natural
Fixing/Fijación:	Freestanding Apoyo
Accessories/Accesorios:	LED lighting Iluminación LED





FP



FS



FG

## ALTEREGO FP | FS | FG

Designer:	Massimo Tasca + Mattia Li Pomi	
Dimensions and weight Dimensiones y peso:	FP	55 kg
	1150x600 mm H 440 mm	
	FS   FG	98 kg
	2300x600 mm H 440 mm	
Materials/Materiales:	Powder coated steel or Corten steel Acero pintado o Acero Corten	
Fixing/Fijación:	Freestanding or Pre-drilled for anchors Apoyo o Predisposición para tacos	
Accessories/Accesorios:	LED lighting Iluminación LED	

Modules of the Alterego collection composed of planters made of steel sheet, available in two sizes. They can be installed individually or in compositions with the other elements of the Alterego collection. The FP and FG models can be combined with the Alterego OM shading structure.

Módulos de la colección Alterego constituidos por jardineras realizadas en chapa de acero, disponibles en dos tamaños. Se pueden instalar formando composiciones, combinándolos con otros elementos de la colección. Los modelos FP y FG permiten la combinación con la sombrilla OM.

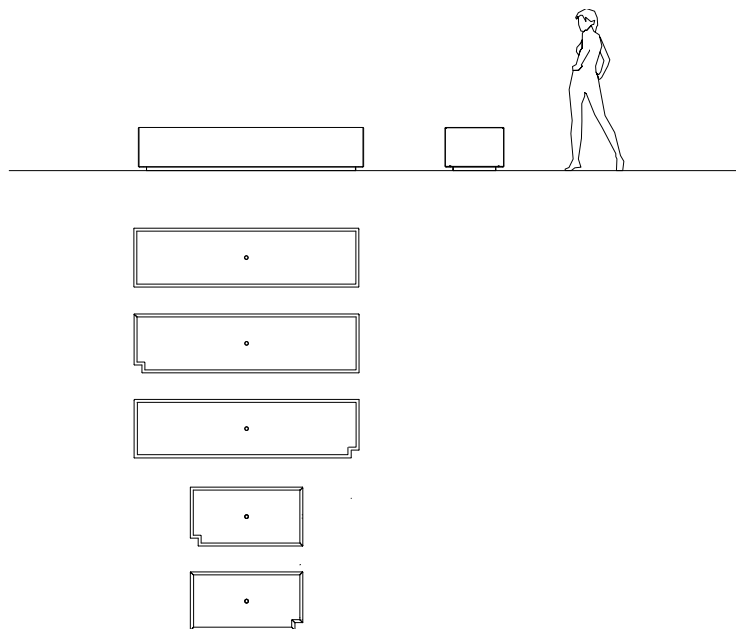



4VC



1VC

Modules of the Alterego collection composed of monolithic seats made of steel sheet, available in two sizes. They can be installed individually or in composition with the other elements of the collection.

Módulos de la colección Alterego constituidos por asientos monolíticos en chapa de acero, disponibles en dos versiones. Se pueden instalar formando composiciones, combinándolos con otros elementos de la colección.

## ALTEREGO 4VC | 1VC

Designer:	Massimo Tasca + Mattia Li Pomi	
Dimensions and weight Dimensiones y peso:	4VC 2300x600 mm H 440 mm	93 kg
	1VC 600x600 mm H 440 mm	25 kg
Materials/Materiales:	Powder coated steel or Corten steel Acero pintado o Acero Corten	
Fixing/Fijación:	Freestanding or Pre-drilled for anchors Apoyo o Predisposición para tacos	
Accessories/Accesorios:	LED lighting Iluminación LED	

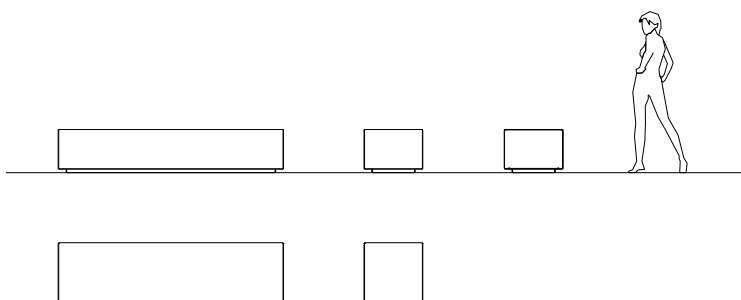

ALTEREGO







OM

Module of the Alterego collection composed of seat in HPC (High Performance Concrete), equipped with shading structure in powder coated steel composed of two tubes and a frame with steel slats. Two versions are available, with or without stainless steel cables.

Módulos de la colección Alterego formados por un asiento en HPC (High Performance Concrete), equipado con una sombrilla de acero pintado formado por dos tubos y un marco con lamias de acero. Disponible en dos versiones con o sin cables de acero inoxidable.

## ALTEREGO OM

Designer:	Massimo Tasca + Mattia Li Pomi
Dimensions and weight Dimensiones y peso:	3980x1940 mm H 2490 mm 1800 kg
Materials/Materiales:	HPC (High Performance Concrete) + Powder coated steel HPC (High Performance Concrete) + Acero pintado
Finishes/Acabados:	HPC Velluto - Natural smooth HPC Velluto - Liso natural
Fixing/Fijación:	Installation with threaded bars Cimentación con varillas roscadas

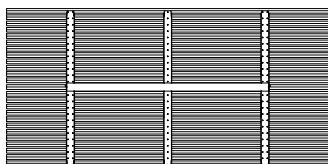
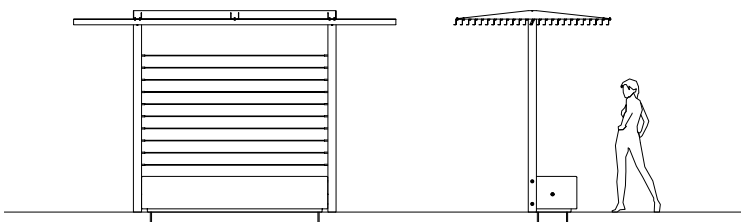



EGO 1



EGO 2



EGO 3



EGO 7



EGO 8



EGO 9



EGO 13



EGO 14



EGO 15



EGO 4



EGO 5



EGO 6



EGO 10



EGO 11



EGO 12



EGO 16



EGO 17



EGO 18





EGO 19



EGO 20



EGO 21



EGO 22



EGO 23



EGO 24





COBRA

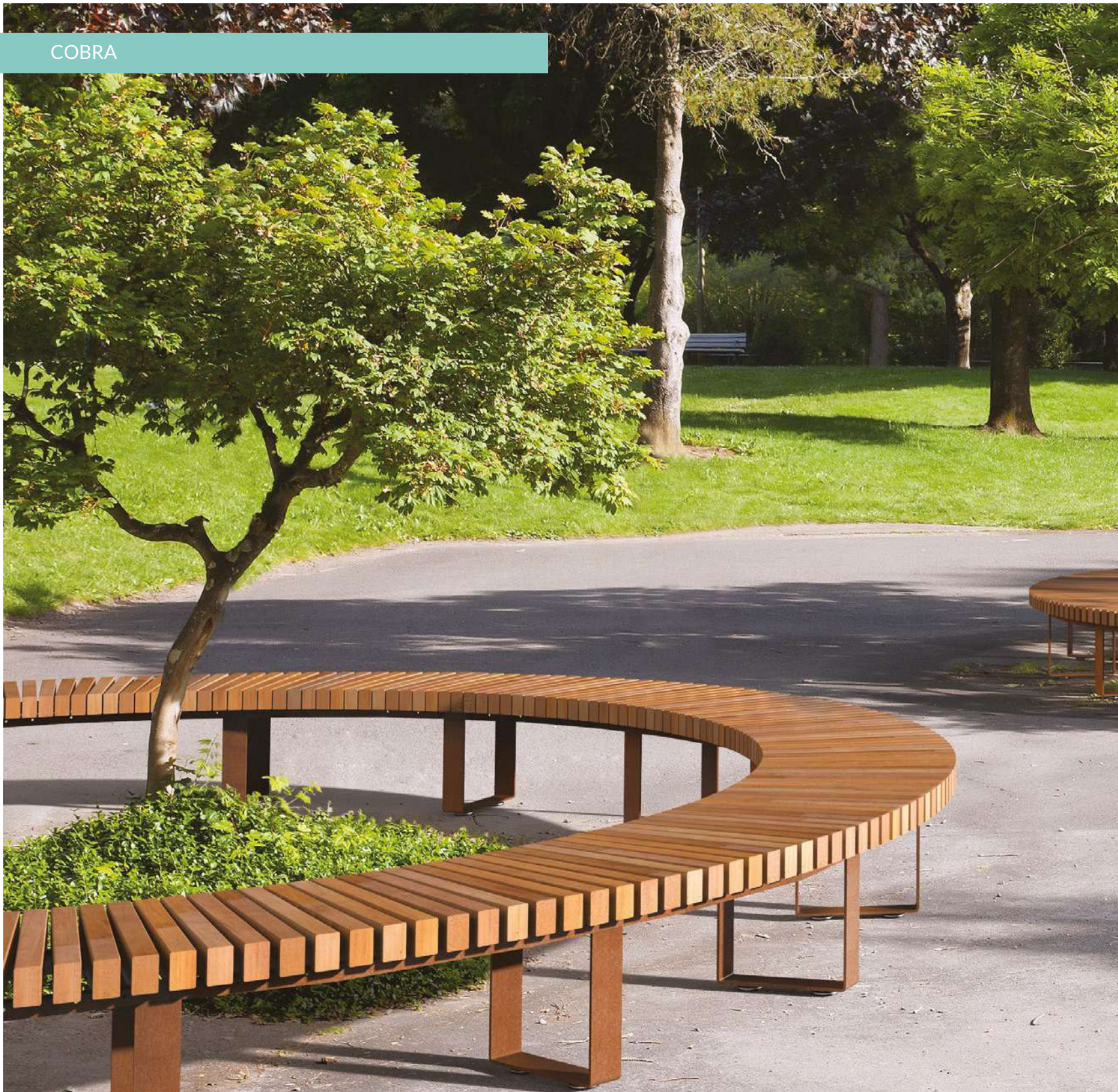









CA1



CA2

## COBRA CA1 | CA2

Designer:	Massimo Tasca	
Dimensions and weight Dimensiones y peso:	1093x1093 mm H 453 mm Hardwood   Madera dura Larch   Alerce	57 kg* 44 kg*
	*only seat without supports *aciento sin soportes	
Materials/Materiales:	Powder coated steel or Corten steel + Hardwood or Larch wood Acero pintado o Acero Corten + Madera dura o Alerce	
Fixing/Fijación:	Pre-drilled for anchors or Below ground installation Predisposición para tacos o Cimentación	

Modules of the Cobra collection consisting of "L" benches, with wooden seat, composed of a supporting structure and supports in plate or steel sheet. Two versions are available: with horizontal or transversal wooden slats, with or without armrests. They can be installed in composition with the other elements of the collection.

Módulos de la colección Cobra constituidos de asientos en "L", con asientos de madera, constituidos de una estructura portante y soportes en acero planos o en chapa de acero. Disponibles en dos versiones con listones en madera horizontal o transversal, con o sin apoyabrazos. Pueden instalarse en composición, combinándolos con otros elementos de la colección.

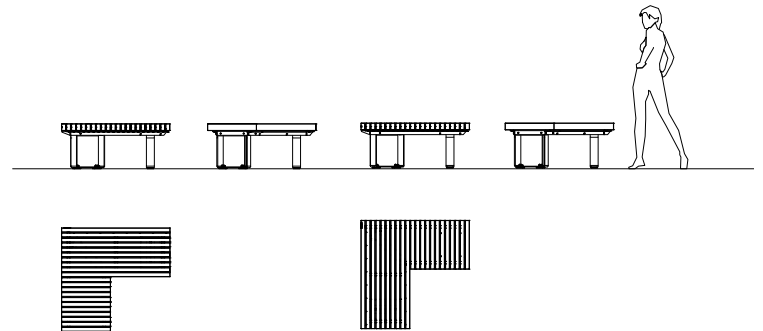



CV



CO



CVS

Modules of the Cobra collection consisting of benches, with or without backrest, composed of a wooden seat, a supporting structure and supports in plate or steel sheet. Two versions are available: with horizontal or transversal wooden slats, with or without armrests. They can be installed in composition with the other elements of the collection.

Módulos de la colección Cobra, formados por asientos, con o sin respaldo, con asientos de madera, constituidos de una estructura portante y de soportes en acero planos o en chapa de acero. Disponibles dos versiones con listones de madera horizontales o transversales, con o sin apoyabrazos. Pueden instalarse en composición, combinándolos con otros elementos de la colección.

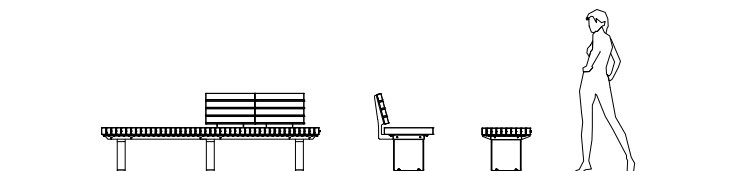

## COBRA CV | CO | CVS

Designer:	Massimo Tasca
Dimensions and weight Dimensiones y peso:	<p><b>CV</b> 2193x493 mm H 453 mm Hardwood   Madera dura 70 kg* Larch   Alerce 54 kg*</p> <p><b>CO</b> 1093x493 mm H 453 mm Hardwood   Madera dura 39 kg* Larch   Alerce 31 kg*</p> <p><b>CVS</b> 2193x493 mm H 792 mm h 453 mm L 500 mm (backrest - dossier) Hardwood   Madera dura 103 kg* Larch   Alerce 84 kg* *only seat without supports *aciento sin soportes</p>
Materials/Materiales:	Powder coated steel or Corten steel + Hardwood or Larch Wood Acero pintado o Acero Corten + Madera dura o Alerce
Fixing/Fijación:	Pre-drilled for anchors or Below ground installation Predisposición para tacos o Cimentación
Accessories/Accesorios:	Armrests - Apoyabrazos





CR



CRS

## COBRA CR | CRS

Designer:	Massimo Tasca
Dimensions and weight Dimensiones y peso:	<p>CR 1832x638 mm Ri 1925 mm h 453 mm H 792 mm Hardwood   Madera dura 52 kg* Larch   Alerce 41 kg*</p> <p>CRS 1832x638 mm Ri 1925 mm h 453 mm H 792 mm Hardwood   Madera dura 59 kg* Larch   Alerce 47 kg* *only seat without supports seul asiento sans supports</p>
Materials/Materiales:	Powder coated steel or Corten steel + Hardwood or Larch wood Acero pintado o Acero Corten + Madera dura o Alerce
Fixing/Fijación:	Pre-drilled for anchors or Below ground installation Predisposición para tacos o Cimentación
Accessories/Accesorios:	Armrests - Apoyabrazos

Modules of the Cobra collection consisting of curved benches, with or without backrest, composed of a wooden seat, a supporting structure and supports in plate or steel sheet. They are available with or without armrests. They can be installed in composition with the other elements of the collection.

Módulos de la colección Cobra formados por asientos curvos, con o sin respaldo, con asientos de madera, constituidos de una estructura portante y soportes en acero planos o en chapa de acero. Disponibles con o sin apoyabrazos. Pueden instalarse en composición, combinándolos con otros elementos de la colección.

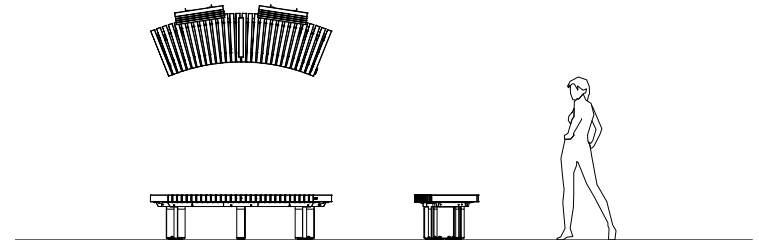
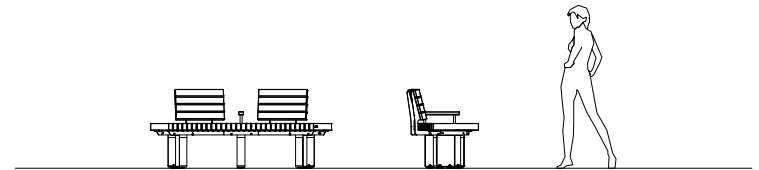

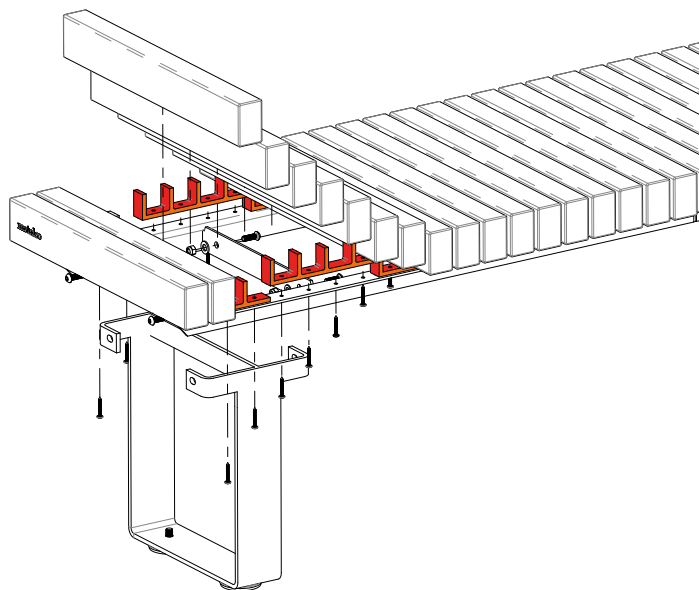

SV



SP

The whole Cobra collection can be equipped with two different types of support: SP made of steel sheet or SV in steel plate. The CA1-CA2-CV-CO-CVS versions are equipped with a fixing system with a technopolymer U-shaped element.

Toda la colección Cobra puede realizarse con dos tipos diferentes de soportes. SP realizado en chapa de acero o SV en acero plano. La versión CA1-CA2-CV-CO-CVS están equipadas con un sistema de fijación con un elemento en forma de U de tecnopolímero.

## COBRA SUPPORTI SV | SP

Designer:	Massimo Tasca						
Dimensions and weight Dimensiones y peso:	<table> <tr> <td>SV</td> <td>306x195 mm H 370</td> <td>7 kg</td> </tr> <tr> <td>SP</td> <td>398x195 mm H 370 mm</td> <td>9 kg</td> </tr> </table>	SV	306x195 mm H 370	7 kg	SP	398x195 mm H 370 mm	9 kg
SV	306x195 mm H 370	7 kg					
SP	398x195 mm H 370 mm	9 kg					
Materials/Materiales:	Powder coated steel or Corten steel Acero pintado o Acero Corten						



COBRA 1



COBRA 2



COBRA 5

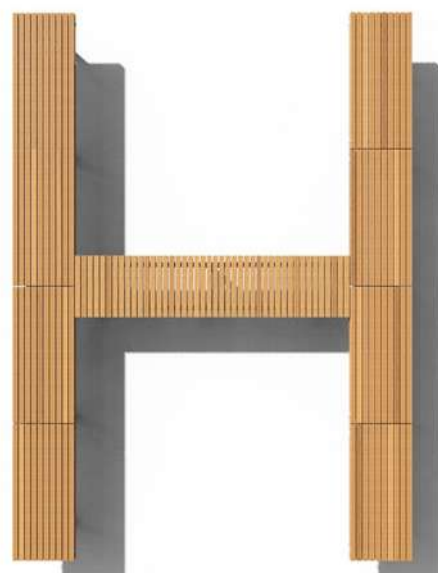

COBRA 6



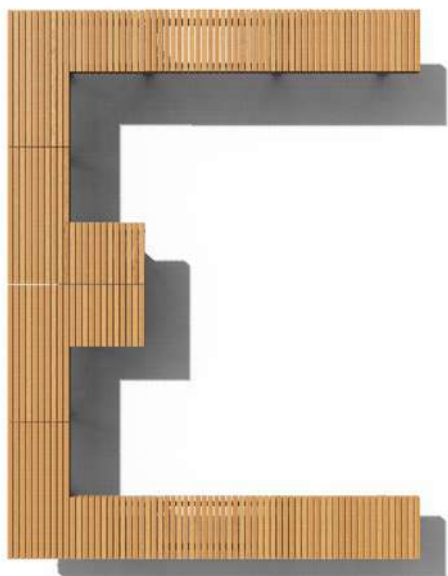

COBRA 3

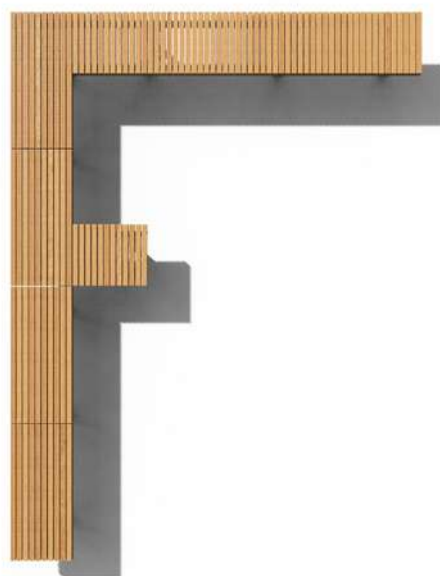

COBRA 4



COBRA 7

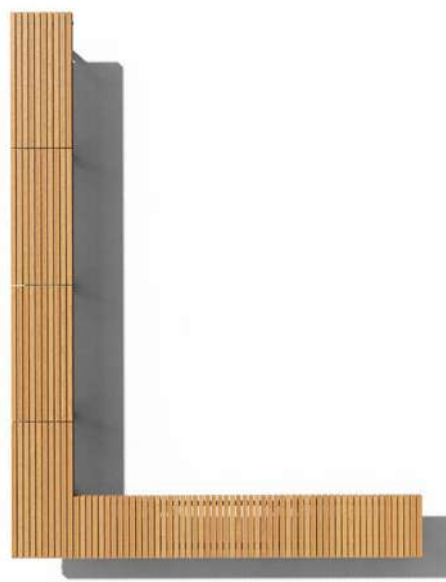

COBRA 8

COBRA

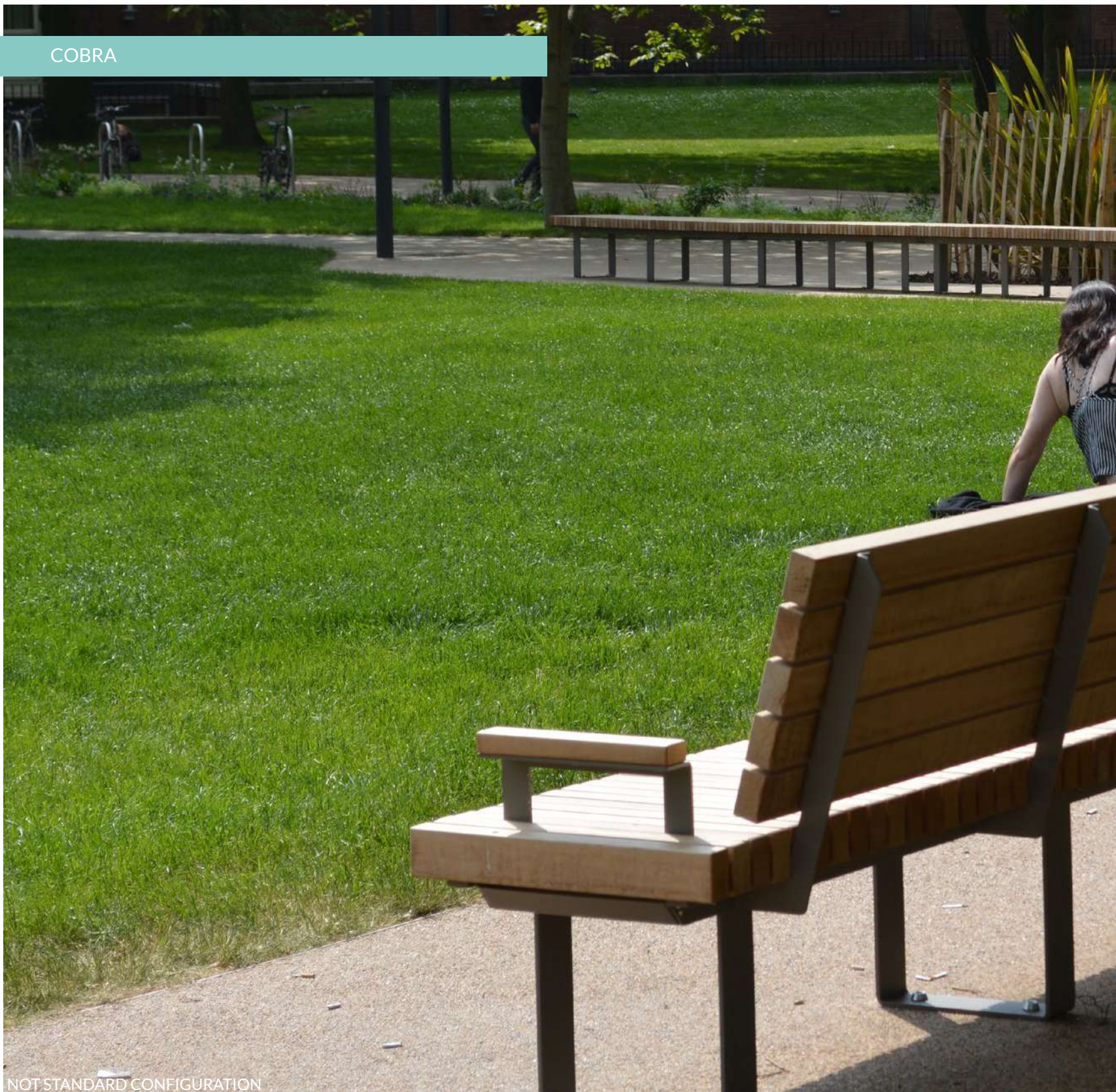

NOT STANDARD CONFIGURATION







ISOLAURBANA

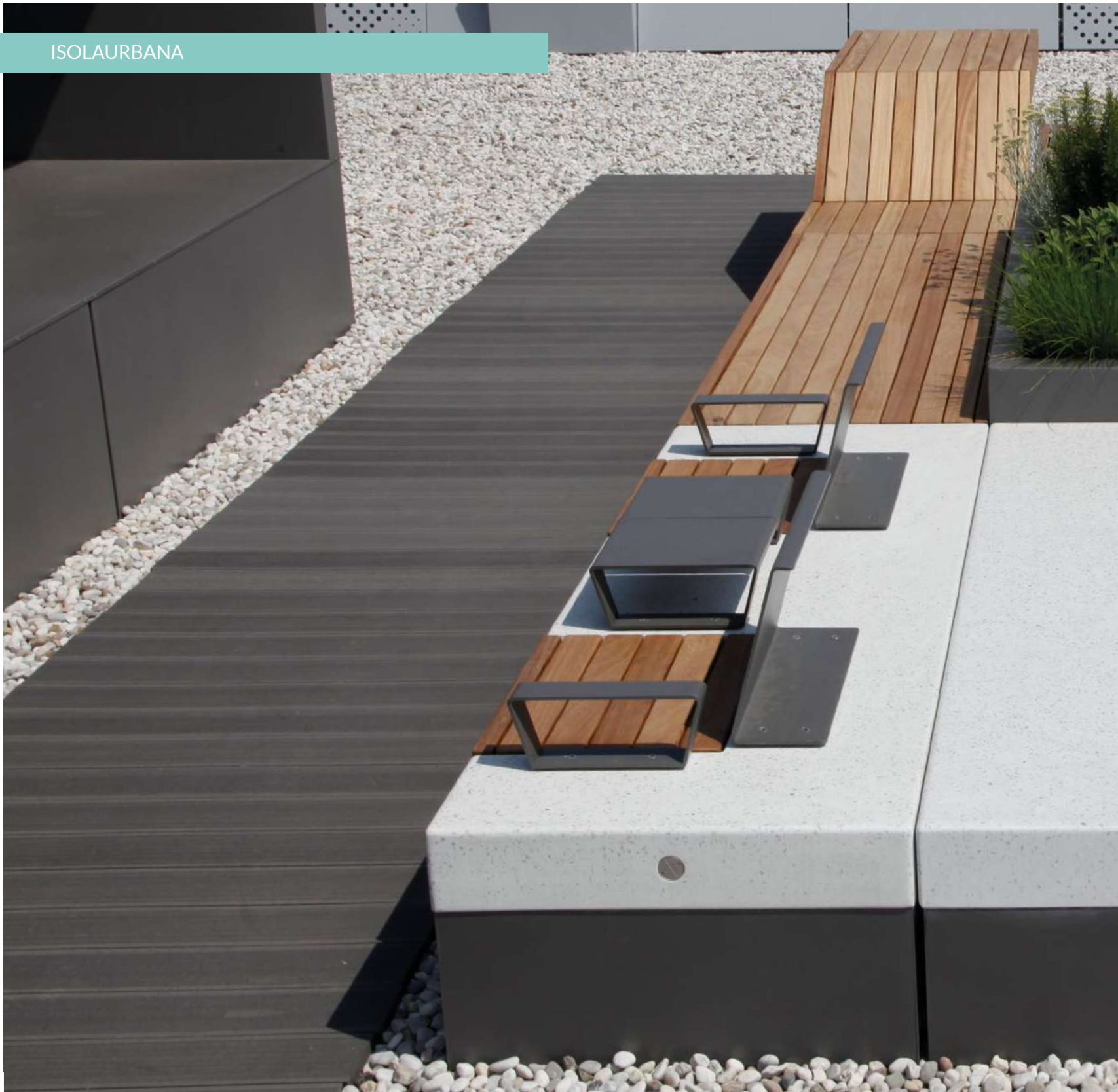







D



W

## ISOLAURBANA D | W

Designer:	Massimo Tasca + Raffaele Lazzari	
Dimensions and weight Dimensiones y peso:	D 2100x750 mm H 420 mm	410 kg
	W 2100x750 mm H 420 mm	110 kg
Materials/Materiales:	HPC (High Performance Concrete) + Powder coated steel + aluminum + Hardwood HPC (High Performance Concrete) + Acero + Aluminio pintado + Madera dura	
Finishes/Acabados:	HPC Velluto - Natural smooth HPC Velluto - Liso natural	
Fixing/Fijación:	Pre-drilled for anchors Predisposición para tacos	
Accessories/Accesorios:	LED lighting Iluminación LED	

Modules of the Isolaurbana collection. The D model is a bench, without backrest, composed of a seat in HPC (High Performance Concrete) and two supports in powder coated aluminum. The W model is a bench without backrest, composed of a wooden seat and two supports in powder coated aluminum. They can be installed in composition with the other elements of the Isolaurbana collection.

Módulos de la colección Isolaurbana. El modelo D es un asiento sin respaldo formado por una superficie que sirve de asiento en HPC (High Performance Concrete) y por dos soportes en aluminio pintado. El modelo W es un asiento sin respaldo, formado por una superficie de madera, que sirve como asiento y por dos soportes en aluminio pintado. Pueden ser instalados en composiciones, combinándolos con los otros elementos de la colección Isolaurbana.

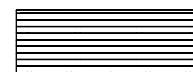
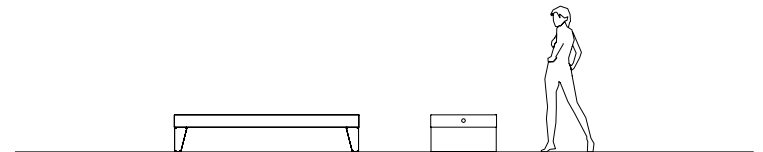





DTS



DTS + A

Modules of the Isolaurbana collection. The DTS model is a bench, without backrest, composed of a seat in HPC (High Performance Concrete), with two wooden inserts and two supports in powder coated aluminum. The DTS+A model is a bench composed of a plane made of HPC (High Performance Concrete), with two single seats composed of a wooden insert, with backrest and armrests in steel sheet. Between the two seats there is a raised steel sheet top, which serves as a table. They can be installed in composition with the other elements of the Isolaurbana collection.

Módulos de la colección Isolaurbana. El modelo DTS es un asiento sin respaldo formado por una superficie que sirve de asiento en HPC (High Performance Concrete) con dos insertos de madera y por dos soportes en aluminio pintado. El modelo DTS+A es un asiento, constituido por una superficie en HPC (High Performance Concrete), con dos asientos monoplaza compuestos por un inserto de madera con respaldo y apoyabrazos en chapa de acero. Entre los asientos hay una superficie elevada, realizada en chapa de acero que sirve como mesa. Pueden ser instalados en composiciones, combinándolos con los otros elementos de la colección Isolaurbana.

## ISOLAURBANA DTS | DTS + A

Designer:	Massimo Tasca + Raffaele Lazzari
Dimensions and weight Dimensiones y peso:	<p><b>DTS</b> 2100x750 mm H 420 mm 531 kg</p> <p><b>DTS + A</b> 2100x750 mm H 738 mm h 420 mm seat   asiento L 500 mm 600 kg</p>
Materials/Materiales:	HPC (High Performance Concrete) + Powder coated steel + aluminum + Hardwood HPC (High Performance Concrete) + Acero + Aluminio pintado + Madera dura
Finishes/Acabados:	HPC Velluto - Natural smooth HPC Velluto - Liso natural
Fixing/Fijación:	Pre-drilled for anchors Predisposición para tacos
Accessories/Accesorios:	LED lighting Iluminación LED

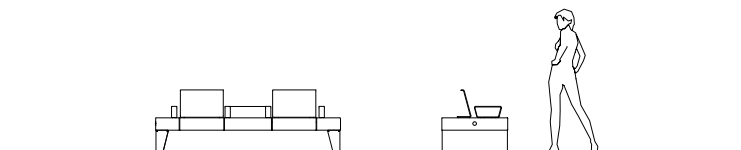



WT



W2

## ISOLAURBANA WT | W2

Designer:	<b>Massimo Tasca + Raffaele Lazzari</b>
Dimensions and weight Dimensiones y peso:	<p><b>WT</b> 2100x750 mm H 790 mm h 420 mm 121 kg</p> <p><b>W2</b> 2100x1500 mm H 420 mm 193 kg</p>
Materials/Materiales:	<p>Powder coated steel + aluminum + Hardwood Acero + Aluminio pintado + Madera dura</p>
Fixing/Fijación:	<p>Pre-drilled for anchors Predisposición para tacos</p>
Accessories/Accesorios:	<p>LED lighting Iluminación LED</p>

Modules of the Isolaurbana collection. The WT model is a cantilevered wooden element with two supports, one in powder coated aluminum, the other in steel sheet, used as a connecting element, as a chaise longue or as a single seat with an extension that serves as a table. The W2 model is a seat, without backrest, composed of a wooden seat and two supports in powder coated aluminum. It can be installed in composition with the others elements of the Isolaurbana collection.

Módulos de la colección Isolaurbana. El modelo WT es un elemento en voladizo de madera con dos soportes, uno en aluminio, el otro en chapa de acero. Puede ser utilizado como elemento de conexión, como chaise longue, como asiento monoplaza con una extensión que puede utilizarse como mesa. El modelo W2 es un asiento sin respaldo constituido por una superficie en madera que sirve de asiento y por dos soportes en aluminio pintado. Pueden ser instalados en composición con los otros de la colección Isolaurbana.

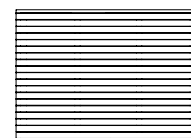
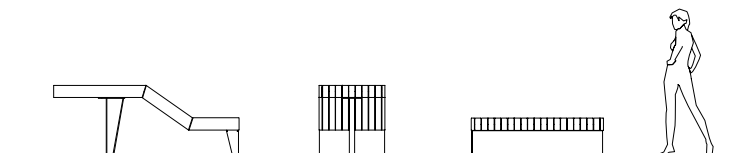

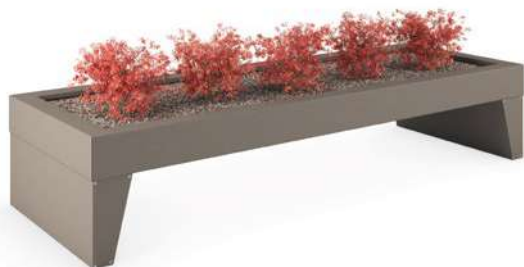

FB



FA

Modules of the Isolaurbana collection composed of two rectangular planters with steel sheet structure and two supports in powder coated aluminum. Two heights are available.

Módulos de la colección Isolaurbana constituidos por dos jardineras rectangulares con estructura en chapa de acero y dos soportes en aluminio pintado. Disponibles dos tamaños.

## ISOLAURBANA FB | FA

Designer:	Massimo Tasca + Raffaele Lazzari	
Dimensions and weight Dimensiones y peso:	FB 2100x750 mm H 420 mm	70 kg
	FA 2100x750 mm H 560 mm	82 kg
Materials/Materiales:	Powder coated steel + aluminum Acero + Aluminio pintado	
Fixing/Fijación:	Pre-drilled for anchors Predisposición para tacos	
Accessories/Accesorios:	LED lighting Iluminación LED	

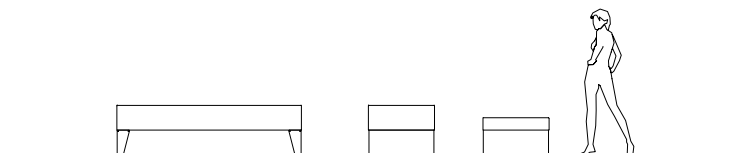



ISOLAURBANA



ISO 1



ISO 2



ISO 3



ISO 7

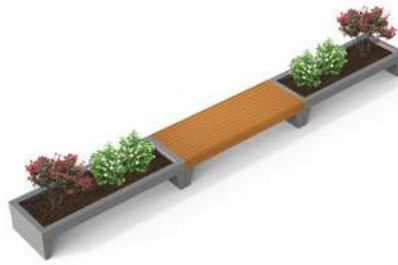

ISO 8

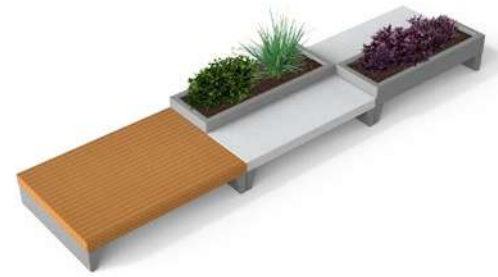

ISO 9



ISO 13

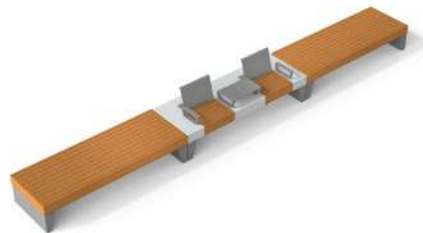

ISO 14

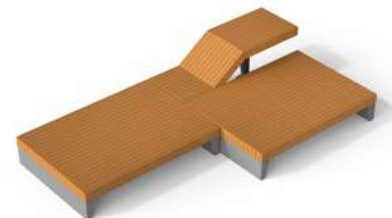

ISO 15



ISO 4



ISO 5



ISO 6



ISO 10



ISO 11



ISO 12



ISO 16

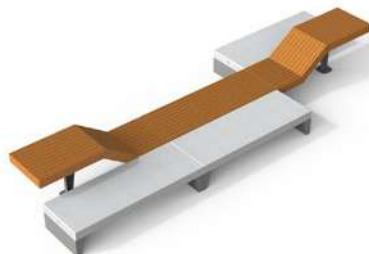

ISO 17

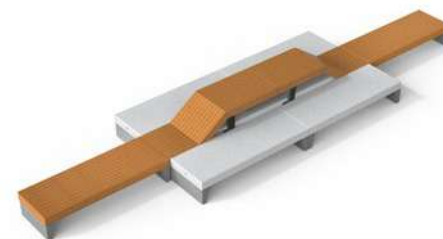

ISO 18



ISO 19



ISO 20



ISO 21



ISO 24



ISO 25



ISO 26





ISO 22



ISO 23

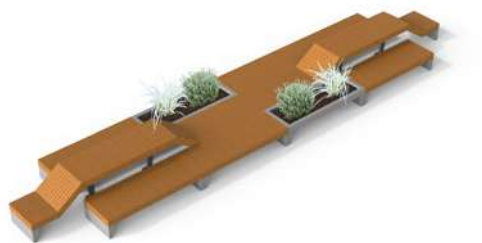

ISO 27



ISO 28

ISOLAURBANA









ISOLAURBANA

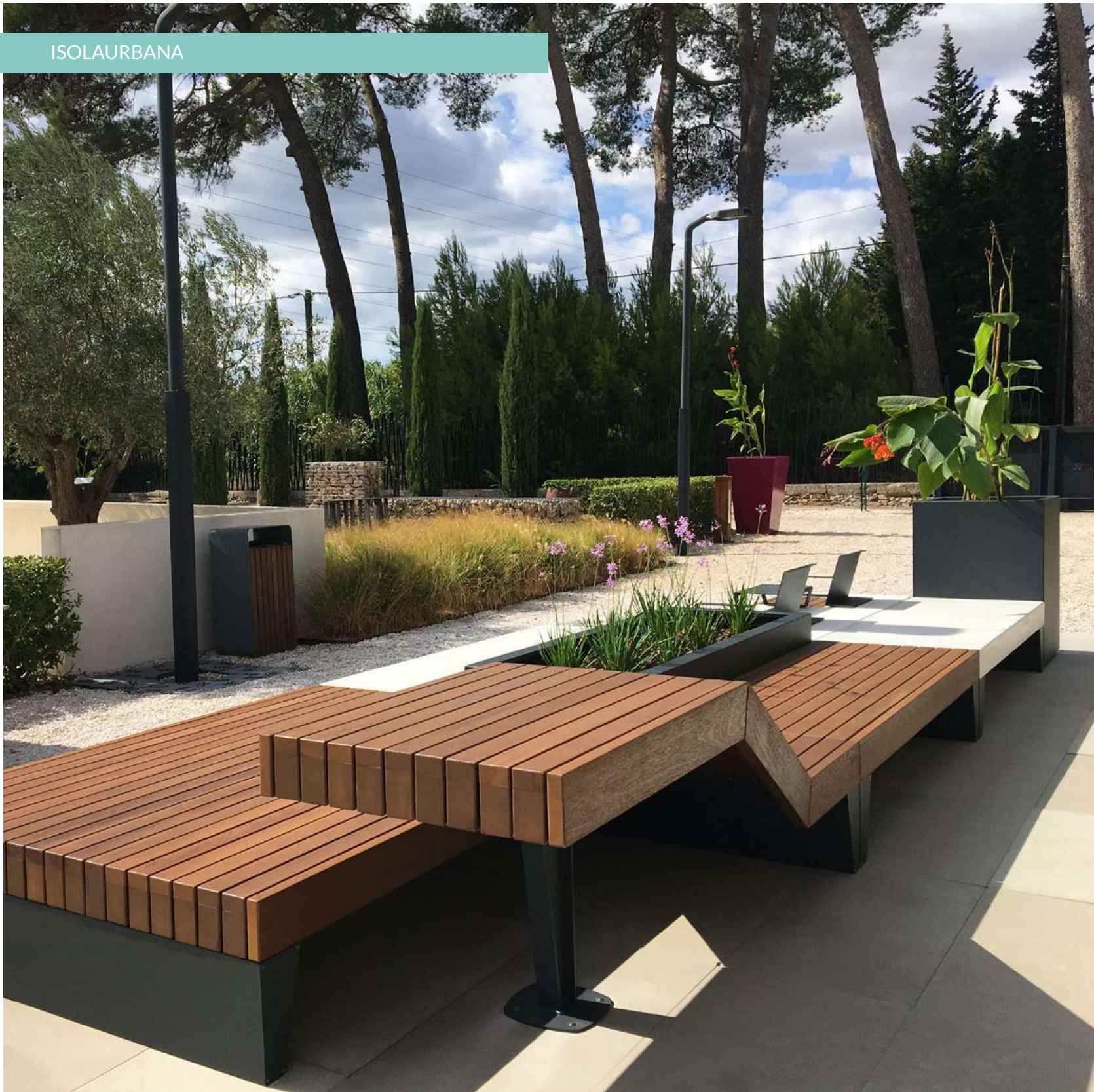









# METALCO COMFORT PROGRAM: TECHNOLOGY FOR THE BODY'S WELL-BEING

Metalco  
Comfort Program:  
Tecnología  
para el bienestar  
del cuerpo

METALCO COMFORT PROGRAM









## **INTELLIGENT TECHNOLOGY THAT RESPECTS THE ENVIRONMENT**

**Thanks to its innovative functions, Metalco Comfort Program allows you to set and program the ideal temperature, avoiding unnecessary waste. In addition, it does not produce dust and gases, harmful to the environment, nor does it produce noise pollution.**

## UNA TECNOLOGÍA INTELIGENTE QUE RESPETA EL MEDIO AMBIENTE

Gracias a sus innovadoras funciones, Metalco Comfort Program permite configurar y programar la temperatura ideal, evitando desperdicios innecesarios. Además, no produce polvos y gases nocivos para el medio ambiente, ni contaminación acústica.



## METALCO COMFORT PROGRAM

### FIR technology for the body's well-being

Metalco Comfort Program is a project born from the awareness that the heat emitted by FIR rays is extremely beneficial for our body: an idea that combines design, technology and functionality to transform street furniture elements into heating systems.

Developed in collaboration with Thermal Technology, a pioneer in the heating sector, FIR technology applied in some of our products guarantees energy efficiency\*, spreading heat evenly across the surface and bringing the temperature up to a maximum of 36°C\*\*.

\*In order to optimise the management of the system, an electrical panel is available on request to enable the heating elements to be switched on and off by means of a thermostat timer equipped with a probe for the measurement of the external temperature, or through a timer programmable through twilight function or time slots.

\*\*Evaluations are carried out on the basis of optimal climatic conditions with an outside temperature of 0°C.

### La tecnología FIR para el bienestar del cuerpo

Metalco Comfort Program es un proyecto que nace de la conciencia de que el calor emitido por los rayos FIR es sumamente beneficioso para nuestro cuerpo: una idea que conjuga diseño, tecnología y funcionalidad, para transformar los elementos del mobiliario urbano en sistemas de calefacción.

Desarrollada en colaboración con Thermal Technology, pionera en el sector de la calefacción, la tecnología FIR aplicada en el interior de algunos de nuestros productos garantiza la eficiencia energética, difundiendo el calor uniformemente por la superficie, elevando la temperatura hasta un máximo de 36°C.\*\*

\*Para optimizar la gestión del sistema, bajo solicitud, se puede disponer de un cuadro eléctrico que permite el encendido y apagado de los elementos calefactores mediante un cronotermostato dotado de sonda que mide la temperatura exterior, o mediante un temporizador programable a través la función crepuscular o por horas.

\*\*Las evaluaciones se realizan en función de condiciones climáticas óptimas con una temperatura exterior de 0°C.

METALCO COMFORT PROGRAM







ANTONIO CITTERIO CON TOAN NGUYEN  
INDIO DA COSTA AUDT  
STAUBACH & KUCKERTZ  
UWE KUCKERTZ  
AGENCE LAVERNE PAYSAGISTES  
ALESSANDRO LENARDA  
ALFREDO TASCA  
MASSIMO TASCA  
RAFFAELE LAZZARI  
MATTIA LI POMI  
MICHELE SLAVIERO  
METALCO DESIGN  
AUREL DESIGN URBAIN  
PIO & TITO TOSO  
SJIT  
ALENA MOCOVÀ  
ANDREA MORGANTE + SHIRO STUDIO  
STUDIO ASSOCIATO PECORARO + ABATE + BRUNAZZI

---



# BENCHES: CHOICES THAT INVITE TO SOCIABILITY

Bancos:  
opciones que  
invitan a socializar



KORE









KORE







A



B



C

Collection of free form modular seats in HPC (High Performance Concrete), equipped with four thick steel sheet supports. Three different shapes (A, B, C) are available. The seats can be installed individually or in linear composition (A + B + C).

Colección de asientos modulares, con forma libre en HPC (High Performance Concrete), dotados de cuatro soportes en gruesa chapa de acero. Disponibles en tres formas diferentes (A, B, C). Los asientos pueden ser instalados individualmente o en una composición linear (A + B + C).

## KORE

Designer:	Michele Slaviero
Dimensions and weight Dimensiones y peso:	<p><b>KORE A</b> 1750x1750 mm H 695 mm 522 kg</p> <p><b>KORE B</b> 1750x1750 mm H 1155 mm 680 kg</p> <p><b>KORE C</b> 1750x1750 mm H 1155 mm 633 kg</p>
Materials/Materiales:	<p>HPC (High Performance Concrete) + Powder coated steel HPC (High Performance Concrete) + Acero pintado</p>
Finishes/Acabados:	<p>HPC Velluto - Natural smooth HPC Velluto - Liso natural</p>
Fixing/Fijación:	<p>Installation with threaded bars Cimentación con varillas roscadas</p>

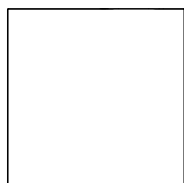
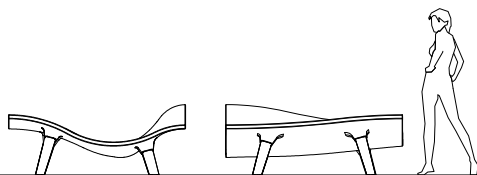

KORE





KORE

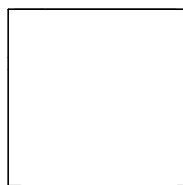
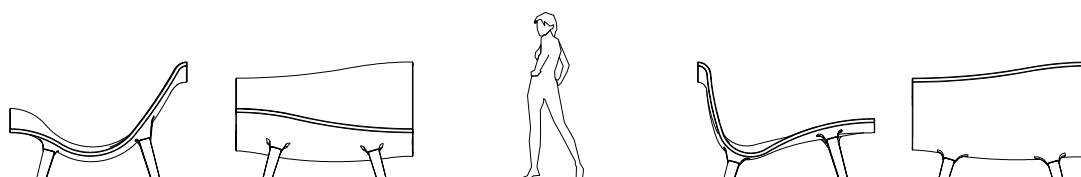



KORE







AMETISTA

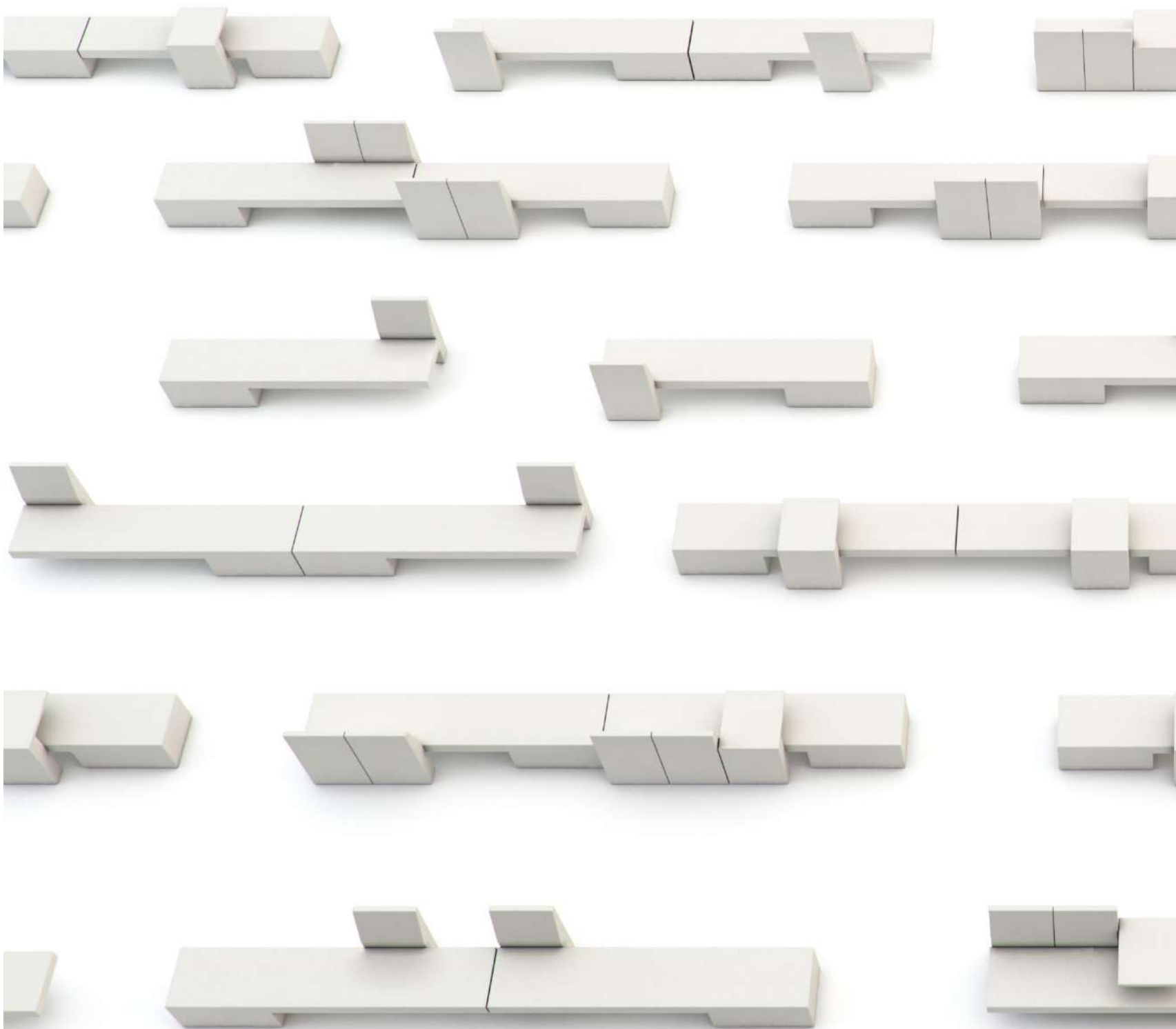



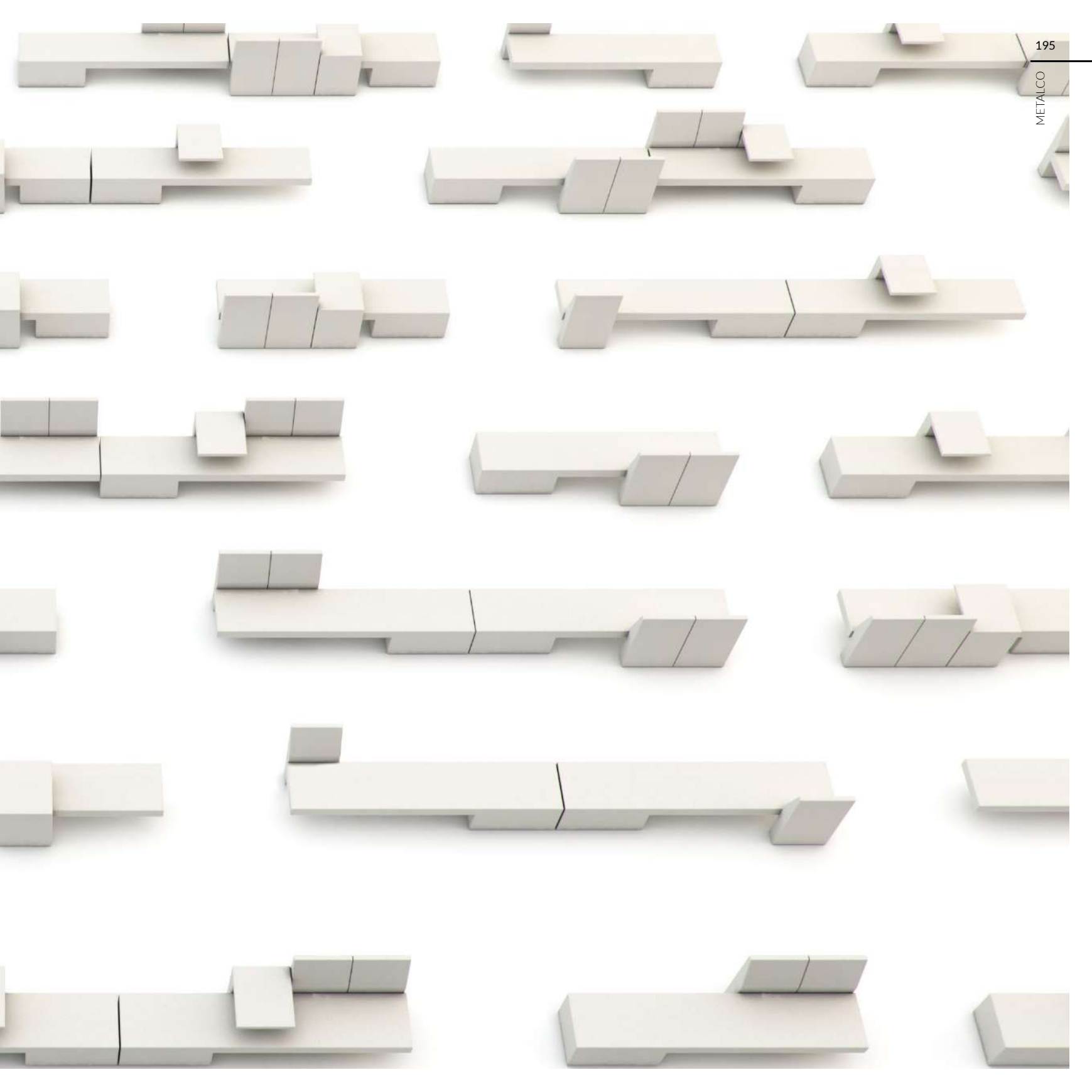

AMETISTA





Collection of modular benches made of HPC (High Performance Concrete). The base composition is composed of a cantilevered monolithic element in combination with at least one backrest module or table module.

Colección de asientos modulares en HPC (High Performance Concrete). La composición básica está formada de un elemento monolítico en voladizo combinado con al menos un módulo con respaldoo o un módulo con mesa.

## AMETISTA

Designer:	Massimo Tasca + Mattia Li Pomi						
Dimensions and weight Dimensiones y peso:	2500x610 mm H 885 mm h 420 mm <table> <tr> <td>seat asiento</td> <td>660 kg</td> </tr> <tr> <td>table mesa</td> <td>125 kg</td> </tr> <tr> <td>backrest respaldo</td> <td>110 kg</td> </tr> </table>	seat asiento	660 kg	table mesa	125 kg	backrest respaldo	110 kg
seat asiento	660 kg						
table mesa	125 kg						
backrest respaldo	110 kg						

Materials/Materiales: HPC (High Performance Concrete)

Finishes/Acabados: Velluto - Natural smooth  
Velluto - Liso natural

Fixing/Fijación: Installation with threaded bars  
Cimentación con varillas roscadas

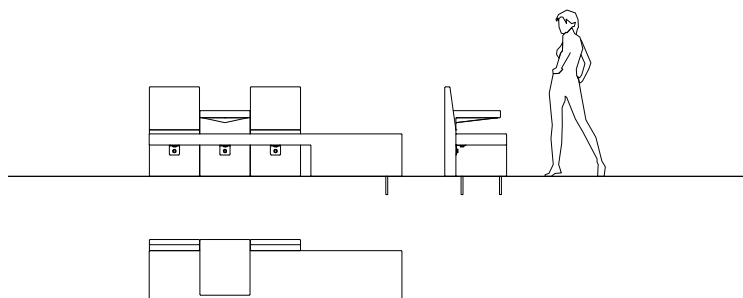



AMETISTA ACCESSORIES





The seat and the backrest compatible with the Ametista collection can be equipped with WPC (Wood Polymer Composite) coating.

El asiento y el respaldo compatibles con la colección Ametista pueden revestirse con WPC (Wood Polymer Composite).

## AMETISTA ACCESSORIES

Designer:	Massimo Tasca + Mattia Li Pomi	
Dimensions and weight Dimensiones y peso:	seat - asiento 2460x460 mm H 30 mm	35 kg
	backrest - respaldo 455x385 mm H 30 mm	6 kg
Materials/Materiales:	WPC Plus (Wood Polymer Composite)	

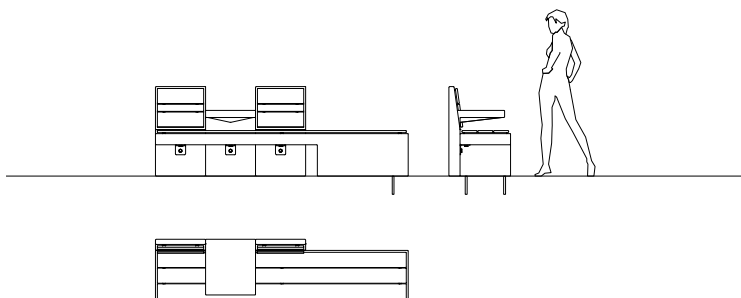

BAILO

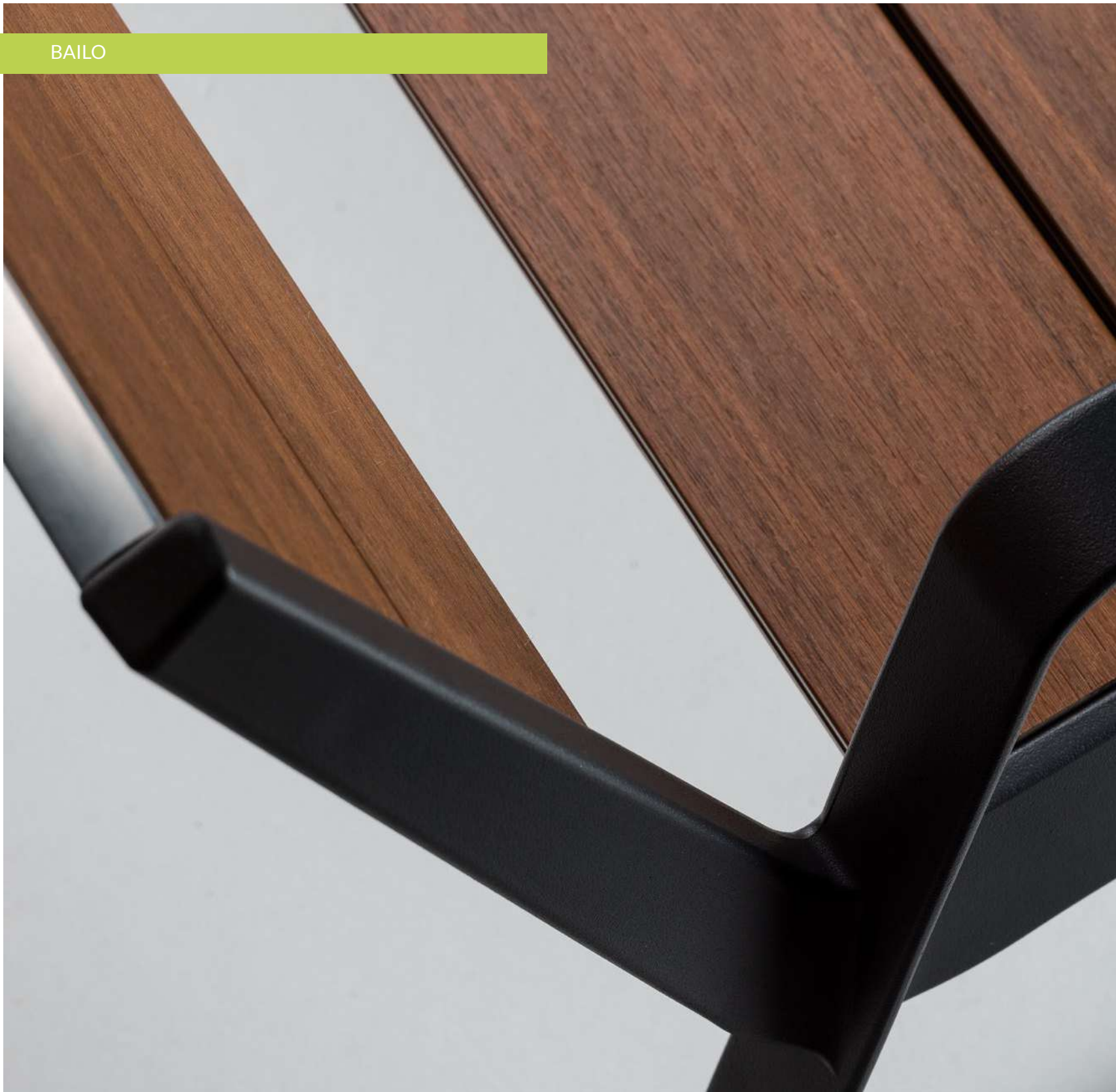



metalco





BAILO











## BAILO WPC

Designer:	Massimo Tasca
Dimensions and weight Dimensiones y peso:	815x645 mm H 810 mm h 434 mm 21 kg
	1865x645 mm H 810 mm h 434 mm 43 kg
Materials/Materiales:	Powder coated steel + Powder coated aluminum + WPC Ultra (Wood Polymer Composite) Acero pintado + Aluminio pintado + WPC Ultra (Wood Polymer Composite)
Fixing/Fijación:	Installation with threaded bars Cimentación con varillas roscadas

Collection of benches composed of backrest and seat in WPC (Wood Polymer Composite) equipped with an aluminum perimeter profile in aluminum and two supports with armrests in powder coated cast aluminum. The single seat version is also available.

Colección de bancos con respaldo y asiento en WPC (Wood Polymer Composite), dotados de una estructura perimetral en aluminio y de dos soportes con apoyabrazos en fundición de aluminio pintado. Disponible también en versión monoplaza.

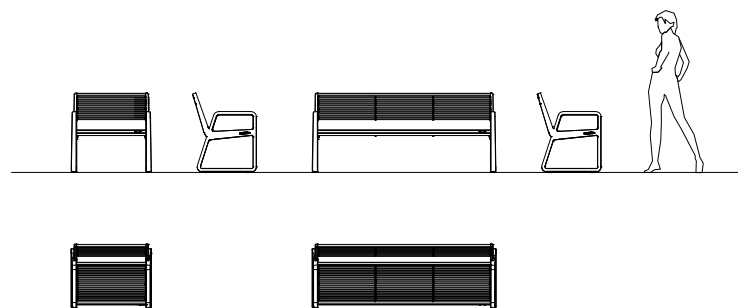



Collection of benches composed of backrest and seat in wood equipped with two supports with armrests in powder coated cast aluminum. The single seat version is also available.

Colección de bancos con respaldo y asiento en madera, dotados de dos soportes con apoyabrazos en fundición de aluminio pintado. Disponible también en versión monoplaza.

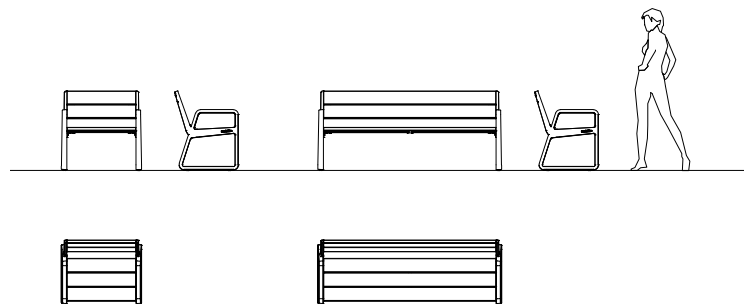

## BAILO W

Designer:	Massimo Tasca
Dimensions and weight Dimensiones y peso:	815x645 mm H 810 mm h 434 mm 24 kg
	1865x645 mm H 810 mm h 434 mm 44 kg
Materials/Materiales:	Powder coated steel + Powder coated aluminum + Hardwood Acero pintado + Aluminio pintado + Madera dura
Fixing/Fijación:	Installation with threaded bars Cimentación con varillas roscadas

BAILO I





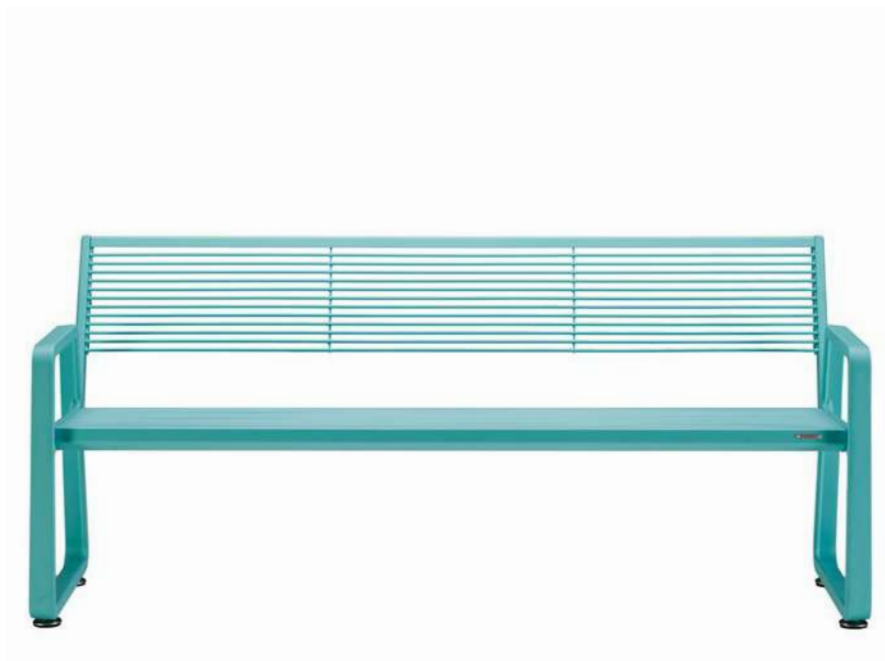

Collection of benches composed of backrest and seat in steel rods equipped with two supports with armrests in powder coated cast aluminum. The single seat version is also available.

Colección de bancos con respaldo y asiento en varillas de acero, dotado de dos soportes con apoyabrazos en fundición de aluminio pintado. Disponible también en versión monoplaza.

## BAILO I

Designer:	Massimo Tasca
Dimensions and weight Dimensiones y peso:	815x645 mm H 810 mm h 434 mm 26 kg
	1865x645 mm H 810 mm h 434 mm 47 kg
Materials/Materiales:	Powder coated steel + Powder coated aluminum Acero pintado + Aluminio pintado
Fixing/Fijación:	Installation with threaded bars Cimentación con varillas roscadas

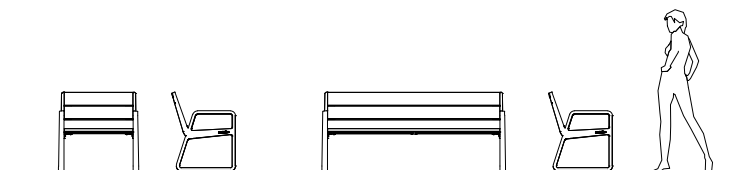

BAILO







ATOLLO









ATOLLO

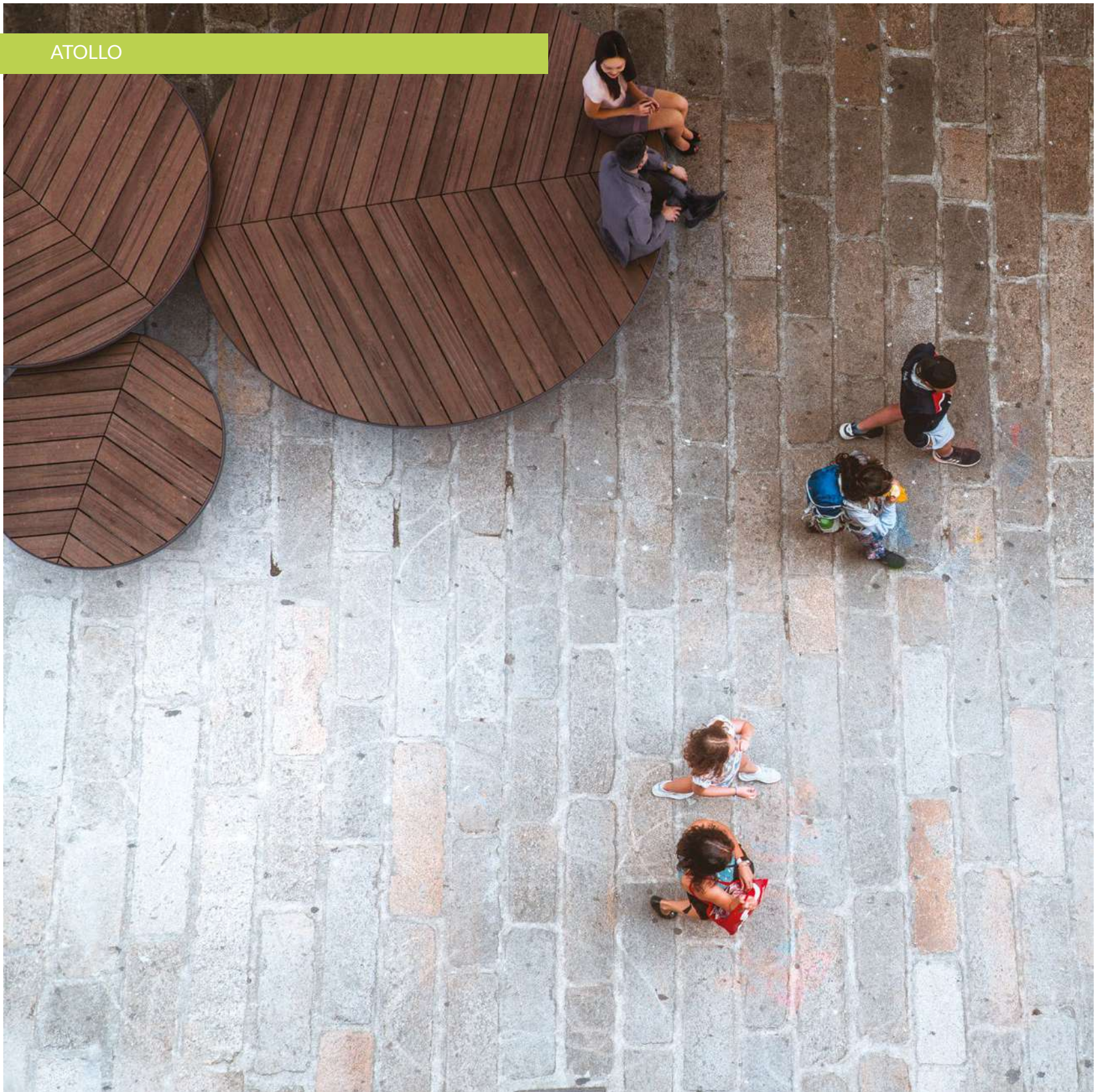





Collection of circular seats composed of a frame and steel supports, an aluminum perimeter frame and a seating plane in wood, arranged in herringbone pattern.

Colección de asientos circulares formados por una estructura y soportes de acero, de un marco perimetral de aluminio y de un asiento de madera, dispuestos en forma de espiga.

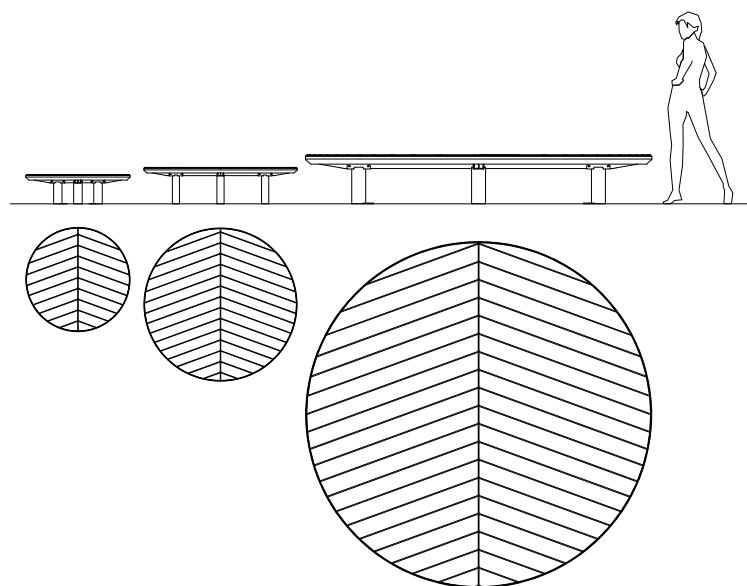

## ATOLLO

Designer:	Pio & Tito Toso	
Dimensions and weight Dimensiones y peso:	<b>ATOLLO 1500</b> Ø 1490 mm H 420 mm	109 kg
	<b>ATOLLO 2200</b> Ø 2190 mm H 520 mm	180 kg
	<b>ATOLLO 3000</b> Ø 2950 mm H 420 mm	313 kg
Materials/Materiales:	Powder coated steel + Powder coated aluminum + Hardwood Acero pintado + Aluminio pintado + Madera dura	
Fixing/Fijación:	Pre-drilled for anchors or Below ground installation Predisposición para tacos o Cimentación	



ATOLLO











## CANN

Designer:	Massimo Tasca
Dimensions and weight Dimensiones y peso:	2270x751 mm H 430 mm 660 kg
Materials/Materiales:	PDM (Reconstituted Stones) PDM (Piedras Reconstituidas)
Finishes/Acabados:	Brushed top + Sandblasted sides Parte superior trabajada con púas rígidas + laterales tratados con chorro de arena
Fixing/Fijación:	Installation with threaded bars Cimentación con varillas roscadas
Accessories/Accesorios:	Stainless steel coating for the base Revestimiento base en Inox  LED lighting Iluminación LED

Monolithic cantilevered bench in PDM (Reconstituted Stones), with recess at the base.

Banco monolítico con voladizo realizado en PDM (Piedras Reconstituidas), con rebajo en la base.

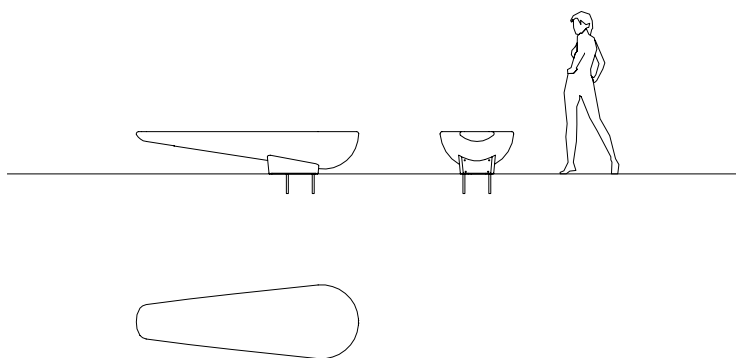



Collection of polyedric seats, made of HPC (High Performance Concrete), partially emptied inside. Two sizes are available.

Colección de asientos de forma poliédrica, aligerados internamente, realizados en HPC (High Performance Concrete). Disponible en dos tamaños.

## HOBA

Designer:	Pio & Tito Toso	
Dimensions and weight Dimensiones y peso:	HOBA A 1048x602 mm H 450 mm	300 kg
	HOBA B 2000x602 mm H 450 mm	570 kg
Materials/Materiales:	HPC (High Performance Concrete)	
Finishes/Acabados:	Velluto - Natural smooth Velluto - Liso natural	
Fixing/Fijación:	Freestanding with pedestals or Installation with threaded bars Apoyo con pies o Cimentación con varillas roscadas	

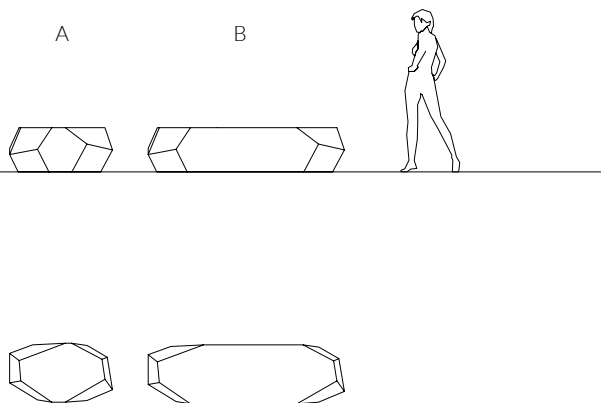



CMP



CMS

## CORTOMADERE CMP | CMS

Designer:	Agence Laverne Paysagistes	
Dimensions and weight Dimensiones y peso:	CMP	46 kg
	CMS	75 kg
Materials/Materiales:	Powder coated steel or Corten steel + Robinia/Acacia Glulam Acero barnizado o Acero Corten + Madera laminada encolada de Robinia/Acacia	
Fixing/Fijación:	Pre-drilled for anchors Predisposición para tacos	

Collection of single seats made of steel sheet and covered with a panel in Acacia/Robinia glulam. Two versions, with or without backrest, are available.

Colección de asientos monoplaza, realizados en chapa de acero y revestidos de paneles en madera laminada encolada de Robinia/Acacia. Disponibles en dos versiones, con o sin respaldo.

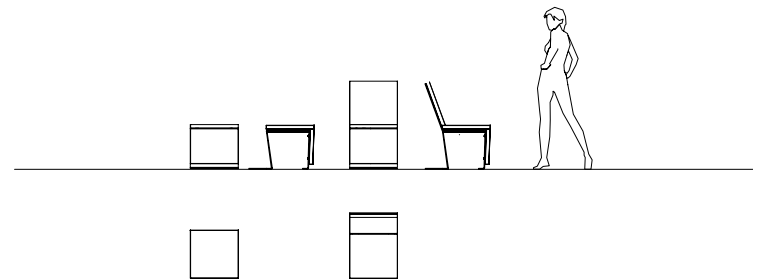





CMC



Chaise longue made of steel sheet, covered with an Robinia/Acacia glulam panel.

Chaise longue realizada en chapa de acero y revestida con un panel en madera laminada encolada de Robinia/Acacia.

## CORTOMADERE CMC

Designer:	Agence Laverne Paysagistes
Dimensions and weight Dimensiones y peso:	800 x2033 mm H 668 mm h 407 mm 160 kg
Materials/Materiales:	Powder coated steel or Corten steel + Robinia/Acacia Glulam Acero barnizado o Acero Corten + Madera laminada encolada de Robinia/Acacia
Fixing/Fijación:	Pre-drilled for anchors Predisposición para tacos

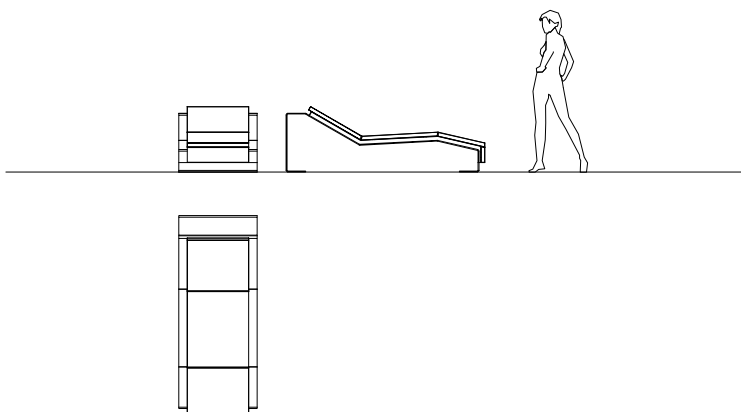

CORTOMADERE





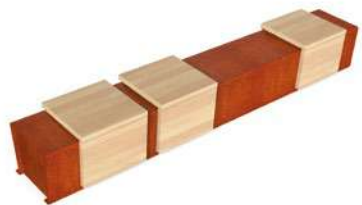

CM3P



CM3S

Collection of benches made of steel composed of a steel sheet supporting structure with three panels in Robinia/Acacia glulam that act as single seats. Two versions, with or without backrest, are available.

Colección de bancos en acero, formados por una estructura portante en chapa de acero con tres paneles en madera laminada encolada de Robinia/Acacia que actúan como asiento monoplaça. Disponibles dos versiones, con o sin respaldo.

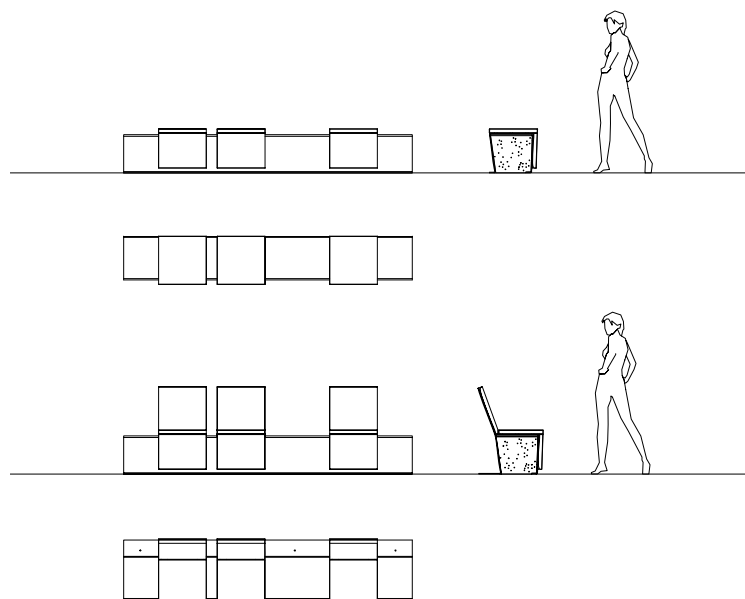

## CORTOMADERE CM3P | CM3S

Designer:	Agence Laverne Paysagistes	
Dimensions and weight Dimensiones y peso:	<b>CM3P</b> 2950x490 mm H 450 mm 267 kg	
	<b>CM3S</b> 2950x670 mm H 893 mm h 450 mm 369 kg	
Materials/Materiales:	Powder coated steel or Corten steel + Robinia/Acacia Glulam Acero barnizado o Acero Corten + Madera laminada encolada de Robinia/Acacia	
Fixing/Fijación:	Pre-drilled for anchors Predisposición para tacos	



CORTEN STYLE

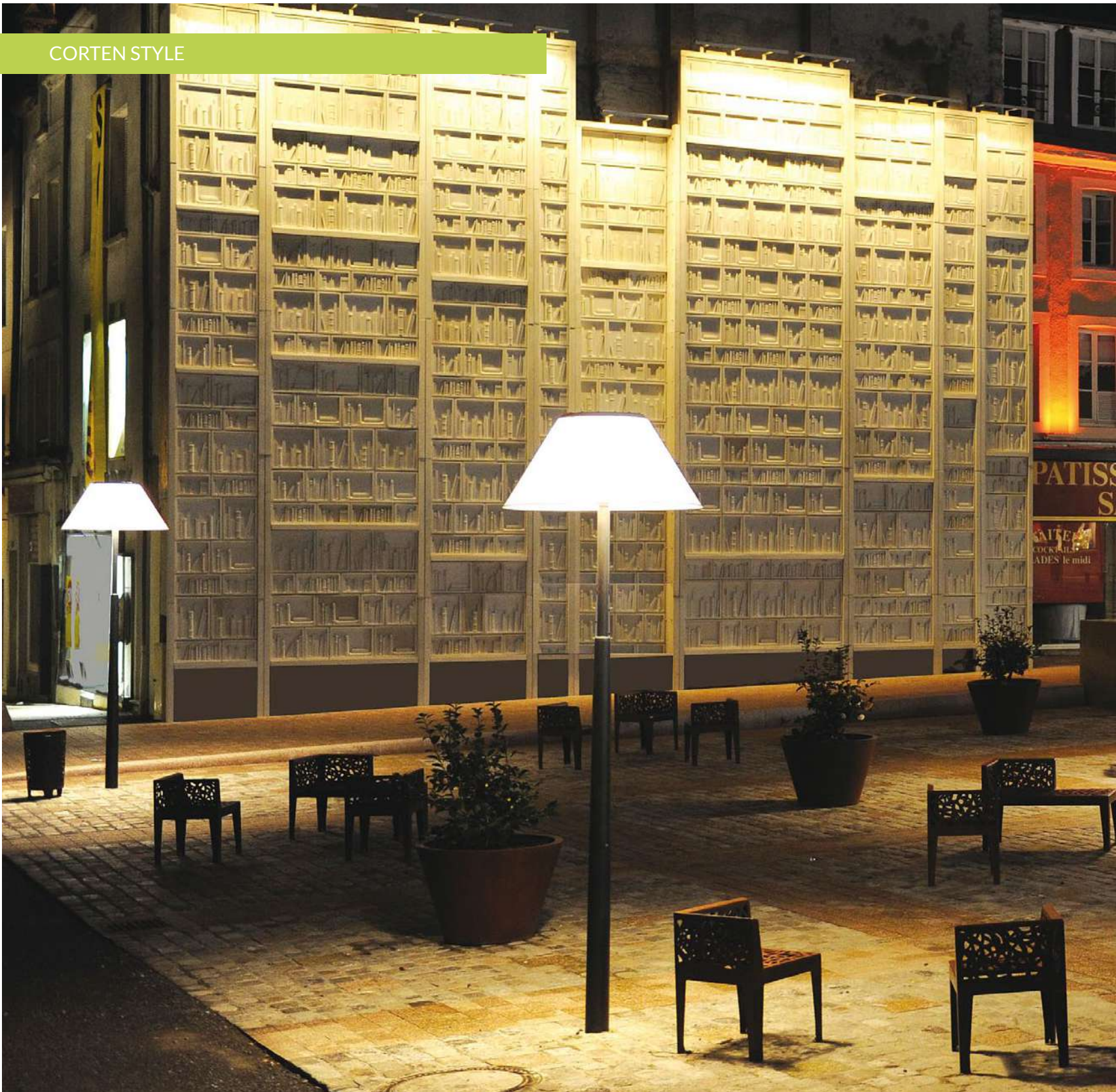







## CORTEN - STYLE

Designer:	Aurel Design Urbain		
Dimensions and weight Dimensiones y peso:	530x530 mm H 710 mm h 451 mm	ELA	23 kg
		LUA	28 kg
	1060x530 mm H 710 mm h 451 mm	DEA	45 kg
		DIVA	35 kg
		STELLA	37 kg
Materials/Materiales:	Corten steel Acero Corten		
Fixing/Fijación:	Pre-drilled for anchors Predisposición para tacos		

Collection of modular benches made of Corten steel sheet with four supports, seat and backrest, the latter decorated with floral patterns. The following versions are available: with one or two seats with linear backrest and one or two seats with angled backrest.

Colección de bancos modulares, realizados en chapa de acero Corten dotados de cuatro soportes, asiento y respaldo, estos últimos decorados con motivos florales. Disponibles modelos con una o dos plazas con respaldoo lineal o con una o dos plazas con respaldoo a ángulo.

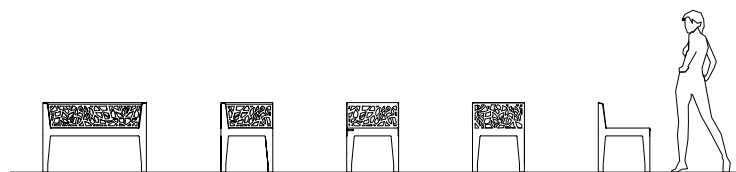





Collection of modular benches made of sheet steel with four supports, seat and backrest, the latter decorated with floral patterns. The following versions are available: with one or two seats with linear backrest and one or two seats with angled backrest.

Colección de bancos modulares, realizados en chapa de acero dotados de cuatro soportes, asiento y respaldo, estos últimos decorados con motivos florales. Disponibles modelos con una o dos plazas con respaldoo lineal o con una o dos plazas con respaldoo a ángulo.

## COLOR - STYLE

Designer: Aurel Design Urbain

Dimensions and weight  
Dimensiones y peso:

530x530 mm H 710 mm h 451 mm	ELA	23 kg
	LUA	28 kg

1060X530 mm H 710 mm h 451 mm	DEA	45 kg
	DIVA	35 kg
	STELLA	37 kg

Materials/Materiales: Powder coated steel  
Acero pintado

Fixing/Fijación: Pre-drilled for anchors  
Predisposición para tacos

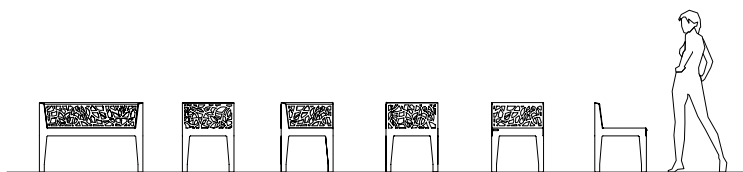

AIR - PORT L





METALCO

BENCHES

Collection of modular benches composed of a wooden seat and two supports in powder coated cast aluminum. Three versions are available: without backrest, with half right backrest and half left backrest.

Colección de bancos modulares con superficie de madera que actúa como asiento y de dos soportes en fundición de aluminio pintado. Disponible en tres versiones: sin respaldo, con medio respaldo derecho y con medio respaldo izquierdo.

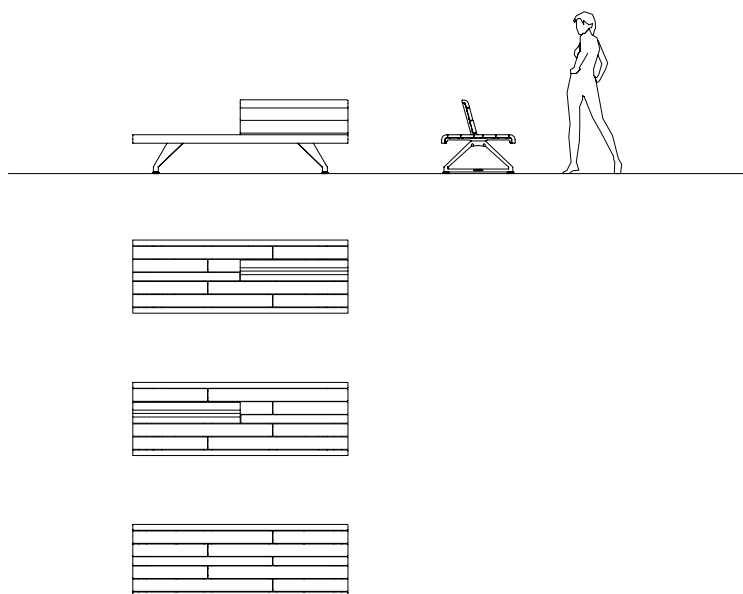

## AIR - PORT L

Designer:	Alfredo Tasca + Massimo Tasca + Raffaele Lazzari		
Dimensions and weight Dimensiones y peso:	AIR - PORT L 2200x750 mm H 408 mm	Hardwood   Madera dura Larch   Alerce	90 kg 76 kg
	AIR - PORT LXS   LDS 2200x750 mm H 408 mm	Hardwood   Madera dura Larch   Alerce	103 kg 86 kg
Materials/Materiales:	Hardwood or Larch + Powder coated aluminum Alerce o Madera dura + Aluminio pintado		
Fixing/Fijación:	Freestanding with pedestals or Installation with threaded bars Apoyo con pies o Cimentación con varillas roscadas		
Accessories/Accesorios:	Fixing kit Kit de fijación		
	Anti-theft screws Tornillos antirrobo		

BANCOS





## AIR - PORT A

Designer:	Alfredo Tasca + Massimo Tasca + Raffaele Lazzari
Dimensions and weight Dimensiones y peso:	AIR - PORT A 2200x750 mm H 400 mm 72 kg
	AIR - PORT A SX   A DX 2200x750 mm H 400 mm 82 kg
Materials/Materiales:	Powder coated aluminum + Powder coated steel Aluminio pintado + Acero pintado
Fixing/Fijación:	Freestanding with pedestals or Installation with threaded bars Apoyo con pies o Cimentación con varillas roscadas
Accessories/Accesorios:	Fixing kit Kit de fijación  Anti-theft screws Tornillos antirrobo



A



A SX



A DX

Collection of modular benches composed of a seat made of steel rods and two supports in powder coated cast aluminum. Three versions are available: without backrest, with half right backrest and half left backrest.

Colección de bancos modulares constituidos de una superficie con varillas de acero que actúa como asiento y de dos soportes en fundición de aluminio pintado. Disponible en tres versiones: sin respaldo, con medio respaldo derecho y con medio respaldo izquierdo.

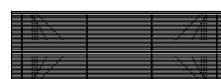
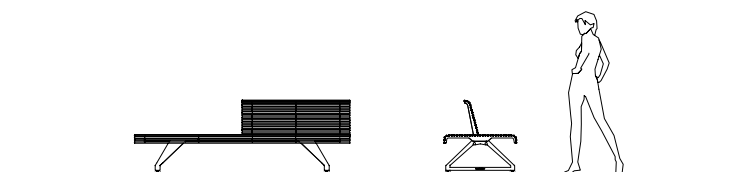



Collection of modular benches composed of a seat in UHPC (Ultra High Performance Concrete) and two supports in powder coated cast aluminum. Three versions are available: linear, curved, linear without supports prepared for wall installation.

Colección de bancos modulares constituidos de una superficie en UHPC (Ultra High Performance Concrete) que actúa como asiento y de dos soportes en fundición de aluminio pintado. Disponible en tres versiones: lineal, sectorial, lineal sin soportes (diseñado para la instalación a muro).

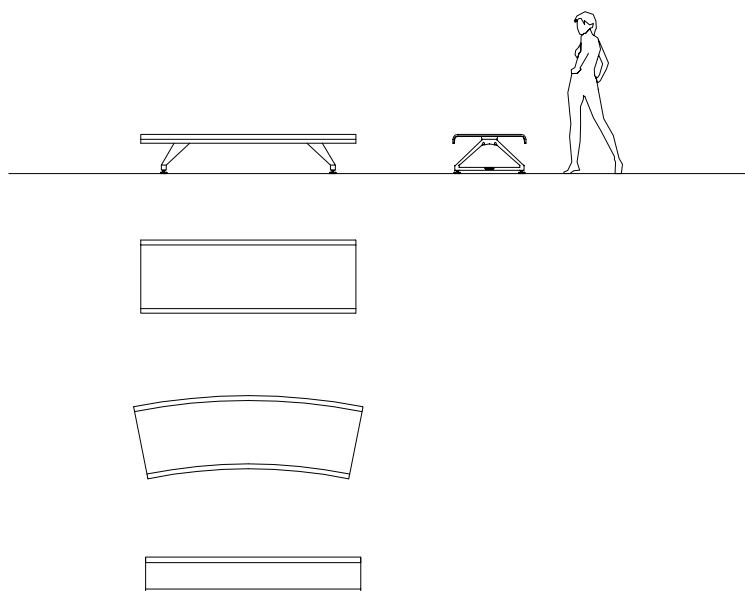

## AIR - PORT C

Designer:	Alfredo Tasca + Massimo Tasca + Raffaele Lazzari	
Dimensions and weight Dimensiones y peso:	AIR - PORT C 2206x750 mm H 408 mm	110 kg
	AIR - PORT CS 2345x750 mm H 408 mm	110 kg
	AIR-PORT CW 2206x420 mm h 85 mm	58 kg
Materials/Materiales:	UHPC (Ultra High Performance Concrete) + Powder coated aluminum UHPC (Ultra High Performance Concrete) + Aluminio pintado	
Finishes/Acabados:	UHPC Alfa - Natural smooth UHPC Alfa - Liso natural	
Fixing/Fijación:	Freestanding with pedestals or Installation with threaded bars Apoyo con pies o Cimentación con varillas roscadas	
Accessories/Accesorios:	Fixing kit Kit de fijación	
	Anti-theft screws Tornillos antirrobo	



## AMBRA

Designer:	Alena Mocová	
Dimensions and weight Dimensiones y peso:	1350x450 mm H 450 mm	327 kg
Materials/Materiales:	PDM (Reconstituted Stones) PDM (Piedras Reconstituidas)	
Finishes/Acabados:	Brushed top + Sandblasted sides Parte superior trabajada con púas rígidas + laterales tratados con chorro de arena	
Fixing/Fijación:	Installation with threaded bars Cimentación con varillas roscadas	

Cantilevered monolithic bench in PDM (Reconstituted Stones).

Banco monolítico en voladizo, realizado en PDM (Piedras Reconstituidas)

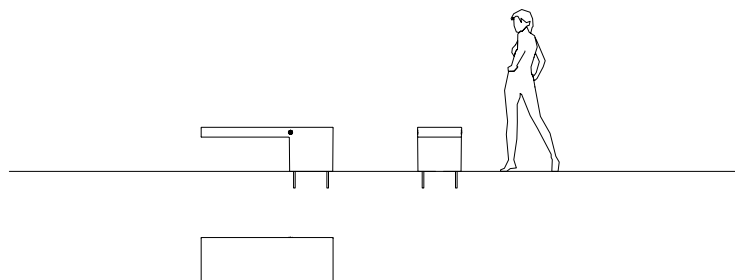





Collection of benches, with or without backrest, composed of two supports in steel plate with armrests covered with wood and a wooden seat.

Colección de bancos con o sin respaldo, constituidos de dos soportes planos de acero, con los apoyabrazos revestidos en madera y de una superficie, también en madera, que hace de asiento.

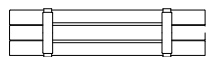
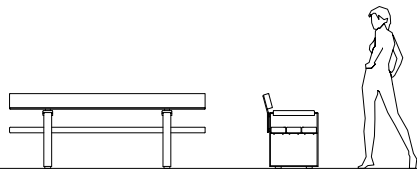

## BULL

Designer:	Alfredo Tasca		
Dimensions and weight Dimensiones y peso:	2000x494 mm h 420 mm		
	Bracciolo   Accoudoir		593 mm
	Hardwood   Madera dura		65 kg
	Larch   Alerce		52 kg
	2000x559 mm h 420 mm H 765 mm		
	Bracciolo   Accoudoir		593 mm
	Hardwood   Madera dura		80 kg
	Larch   Alerce		63 kg
Materials/Materiales:	Powder coated steel or Corten steel + Hardwood Acero pintado o Acero Corten + Madera dura		
Fixing/Fijación:	Pre-drilled for anchors Predisposición para tacos		



## AUSTEN W

Designer:	Metalco Design		
Dimensions and weight Dimensiones y peso:	1150x715x440 mm	Hardwood   Madera dura	105 kg
		Larch   Alerce	95 kg
Materials/Materiales:	UHPC (Ultra High Performance Concrete) + Hardwood or Larch UHPC (Ultra High Performance Concrete) + Madera dura o Alerce		
Finishes/Acabados:	UHPC Alfa - Natural smooth UHPC Alfa - Liso natural		
Fixing/Fijación:	Freestanding with pedestals or Installation with threaded bars Apoyo con pies o Cimentación con varillas roscadas		
Accessories/Accesorios:	LED lighting Iluminación LED		

Modular trapezoidal seat, without backrest, composed of a supporting structure made of UHPC (Ultra High Performance Concrete), with recess at the base, and a wooden seat. It can be installed individually or in compositions with the planter element of the Austen collection.

Asiento modular de forma trapezoidal, sin respaldo, formada por una estructura portante en UHPC (Ultra High Performance Concrete), con rebajo en la base. Se puede instalar individualmente o en composición, combinándolo con el elemento jardinera de la colección Austen.

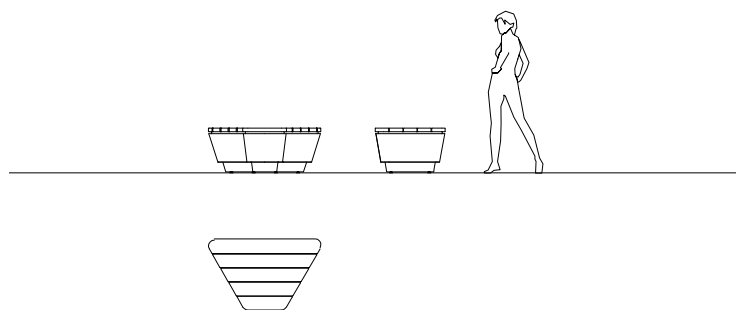



Modular trapezoidal planter composed of a structure made of UHPC (Ultra High Performance Concrete), with recess at the base. It can be installed individually or in composition with the seat modules of the Austen collection.

Jardinera modular de forma trapezoidal, constituida por una estructura en UHPC (Ultra High Performance Concrete), con rebajo en la base. Se puede instalar individualmente o en composición, combinándola con el asiento de la colección Austen.

## AUSTEN F

Designer:	Metalco Design
Dimensions and weight Dimensiones y peso:	1140x705x400 mm 96 kg
Materials/Materiales:	UHPC (Ultra High Performance Concrete)
Finishes/Acabados:	Alfa - Natural smooth Alfa - Liso natural
Fixing/Fijación:	Freestanding with pedestals or Installation with threaded bars Apoyo con pies o Cimentación con varillas roscadas
Accessories/Accesorios:	LED lighting Iluminación LED

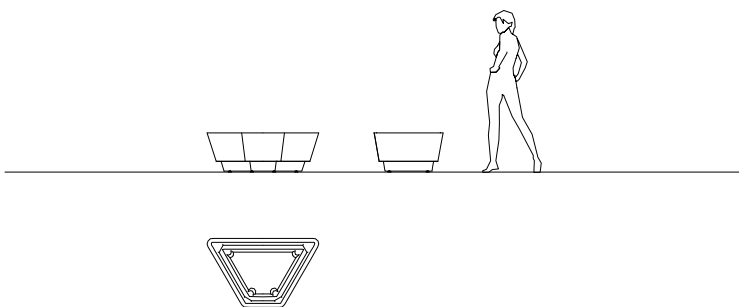





## CAMPUS

Designer:	Metalco Design	
Dimensions and weight	2000x621 mm	87 kg
Dimensiones y peso:	2000x648 mm	107 kg
	H 780 mm h 433 mm	
Materials/Materiales:	Powder coated steel or Corten steel + Hardwood Acero pintado o Acero Corten + Madera dura	
Fixing/Fijación:	Pre-drilled for anchors Predisposición para tacos	

Collection of benches, with or without backrest, composed of steel supports and a wooden seat.

Colección de bancos con o sin respaldo, constituidos de soportes en acero y de una superficie en madera que hace de asiento.

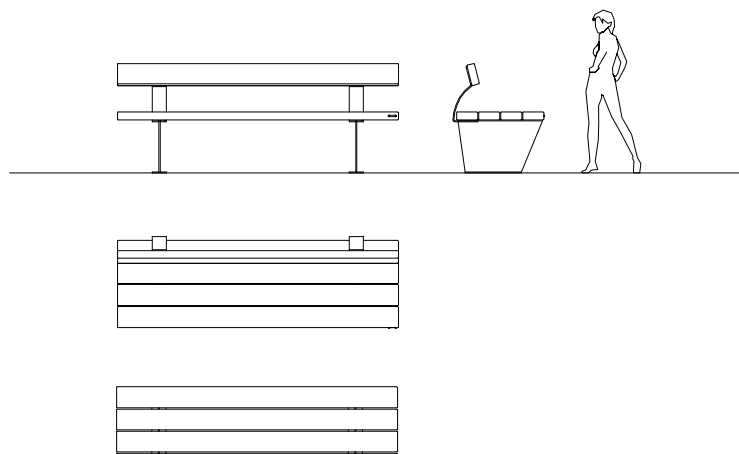



Collection of benches, with or without backrest, composed of steel supports and a wooden seat. Two lengths and widths, with backrests of different size, are available. The versions with backrest are equipped with double-sided seat.

Colección de bancos con o sin respaldo, constituidos de soportes de acero y de una superficie en madera que hace de asiento. Disponible en dos largos y anchos, con respaldos de diferentes tamaños. Las versiones con respaldoo tienen el asiento bilateral.

## CANAPÈ

Designer:	Metalco Design
Dimensions and weight Dimensiones y peso:	3000x850 mm 4000x1030 mm h 443 mm H 708 mm
	A 275   324 kg B 240   365 kg C 200   249 kg
Materials/Materiales:	Powder coated steel or Corten steel + Okume Wood Acero pintado o Acero Corten + Madera de Okume
Fixing/Fijación:	Pre-drilled for anchors Predisposición para tacos

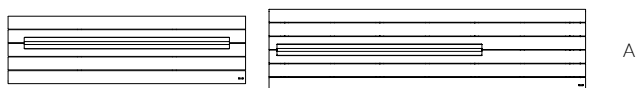

A

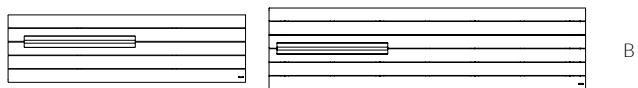

B

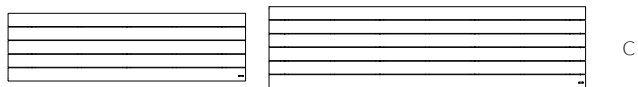

C



## AGATA P

Designer:	<b>Alfredo Tasca</b>
Dimensions and weight Dimensiones y peso:	2100x750 mm H 450 mm 420 kg
Materials/Materiales:	HPC (High Performance Concrete) + Powder coated steel HPC (High Performance Concrete) + Acero pintado
Finishes/Acabados:	HPC Velluto - Natural smooth HPC Velluto - Liso natural
Fixing/Fijación:	Pre-drilled for anchors Predisposición para tacos



Bench composed of a seat in HPC (High Performance Concrete) and a central support base in steel.

Banco formado por una superficie en HPC (High Performance Concrete), que actúa como un asiento y como una base de apoyo central en acero.

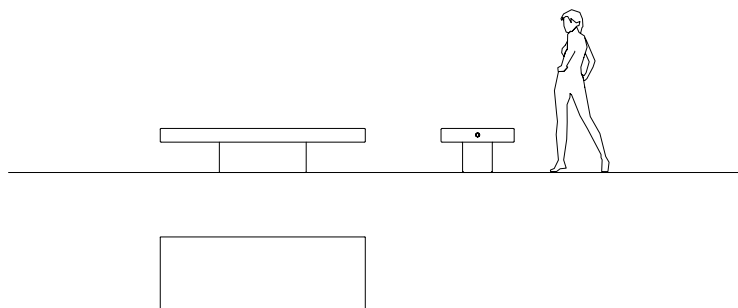





NOT STANDARD CONFIGURATION



BENCHES

Collection of benches composed of two stainless steel plate supports, a steel sheet table plane and three single seats. They are available with backrest decorated with geometric patterns.

Colección de bancos constituidos por dos soportes planos en acero inoxidable, por una superficie de apoyo en chapa de acero y por tres elementos que sirven de asiento monoplaza. Disponible con respaldoo decorado con motivos geométricos.

## FRECCIA

Designer:	Alfredo Tasca + Raffaele Lazzari
Dimensions and weight Dimensiones y peso:	1625x620 mm H 830 mm h 445 mm 83   75 kg
Materials/Materiales:	Powder coated steel + Stainless steel Acero pintado + Acero Inox
Fixing/Fijación:	Freestanding with pedestals or Installation with threaded bars Apoyo con pies o Cimentación con varillas roscadas
Accessories/Accesorios:	Central armrest in stainless steel Apoyabrazos central en acero Inox

BANCOS

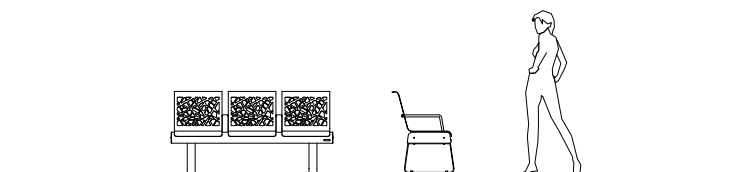



MELANGE

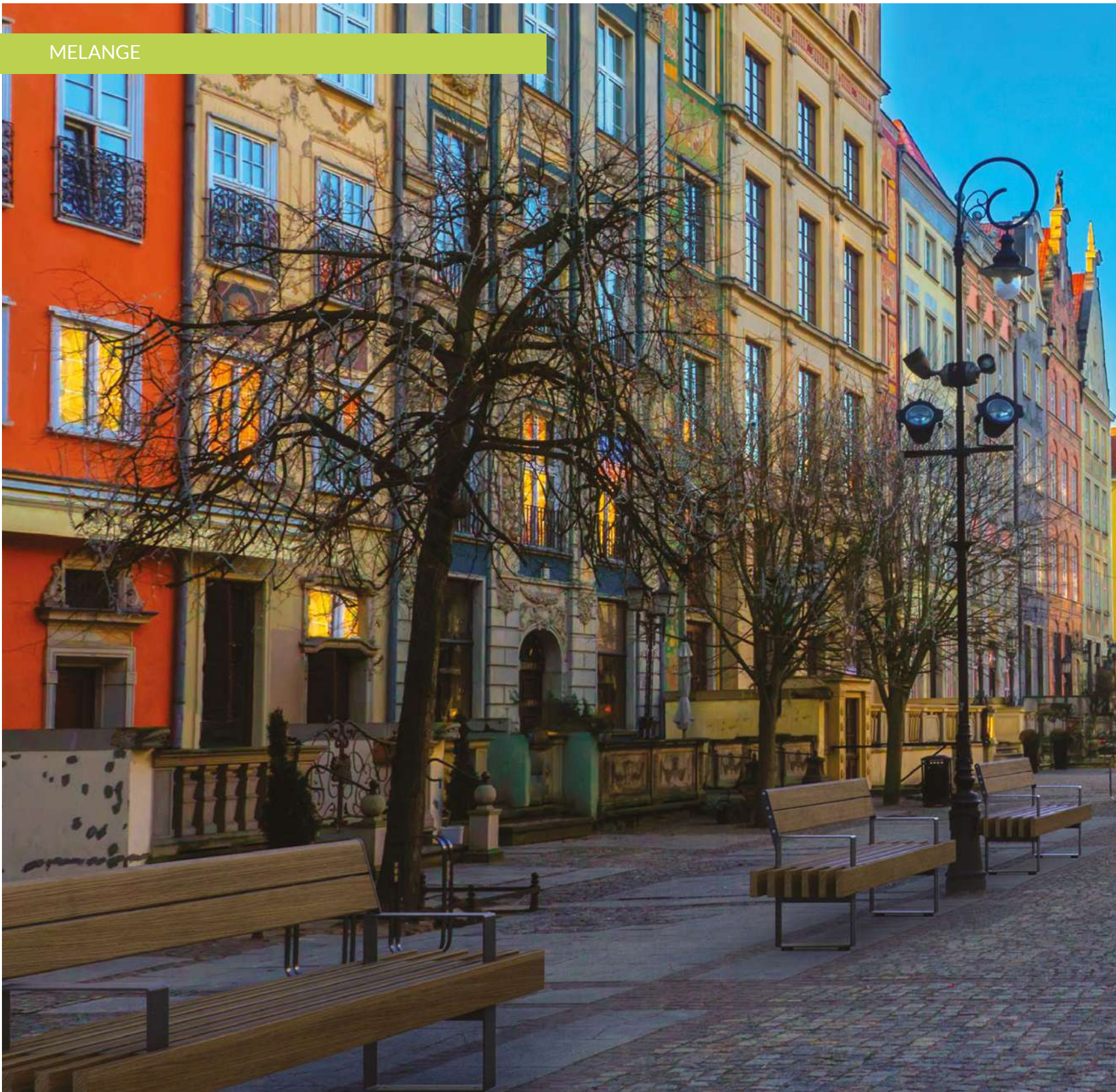







MELANGE





Collection of benches, with or without backrest, with steel plate supports. The seat top is composed of a frame with steel tube profiles, interspersed with wooden slats. Thanks to a stainless steel plate it is possible to use the bench as a bike rack. Two lengths are available.

Colección de bancos con o sin respaldo, con soportes en placa de acero. La superficie del asiento está formada por una estructura con perfiles en tubo de acero, intercalados por listones de madera. Gracias a una placa de acero Inoxidable es posible utilizar el banco como aparcabicicletas. Disponibles en dos largos.

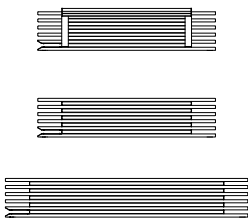
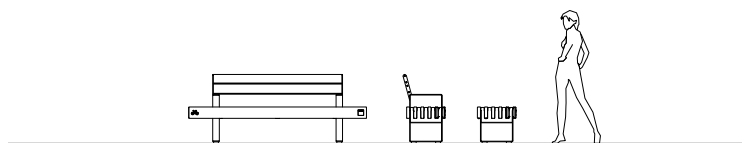

## MELANGE

Designer:	Massimo Tasca	
Dimensions and weight	2200x480 mm H 450 mm	105 kg
Dimensiones y peso:	3000x480 mm H 450 mm	140 kg
	2200x520 mm H 850 mm h 450 mm	125 kg
Materials/Materiales:	Powder coated steel + Hardwood Acero pintado + Madera dura	
Fixing/Fijación:	Pre-drilled for anchors Predisposición para tacos	



NORSE









LW



L2W

## NORSE LW | L2W

Designer: **Massimo Tasca**

Dimensions and weight  
Dimensiones y peso:

**LW**  
2300x635 mm H 453 mm  
seat asiento 1750x462 mm  
136 kg

**L2W**  
2300x635 mm H 453 mm  
seat asiento 750x462 mm  
131 kg

Materials/Materiales:  
Corten steel + WPC Plus (Wood Polymer Composite)  
Acero Corten + WPC Plus (Wood Polymer Composite)

Fixing/Fijación:  
Pre-drilled for anchors  
Predisposición para tacos

Collection of modular benches, without backrest, composed of a monolithic structure, made of Corten steel, equipped with two supports. Two models are available: one with the plane covered by a seat in WPC (Wood Polymer Composite), the other with two single seats in WPC (Wood Polymer Composite).

Colección de bancos modulares, sin respaldo, formados por una estructura monolítica, en acero Corten dotada de dos soportes. Disponibles dos modelos: uno con una superficie revestida por un asiento en WPC (Wood Polymer Composite), el otro con dos asientos monoplaza en WPC (Wood Polymer Composite).

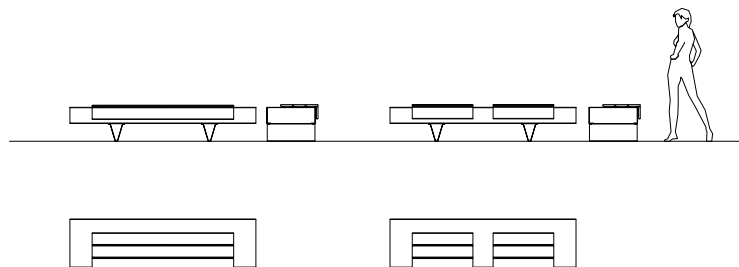





LWS



L2WS

Collection of modular benches, with backrest, composed of a monolithic structure, made of Corten steel, equipped with two supports. Two models are available: one with a plane covered by a seat in WPC (Wood Polymer Composite), the other with two single seats in WPC (Wood Polymer Composite).

Colección de bancos modulares, con respaldo, formados por una estructura monolítica, en acero Corten dotada de dos soportes. Disponibles dos modelos: uno con una superficie revestida por un asiento en WPC (Wood Polymer Composite), el otro con dos asientos monoplaça en WPC (Wood Polymer Composite).

## NORSE LWS | L2WS

Designer:

Massimo Tasca

Dimensions and weight  
Dimensiones y peso:

**LWS**  
2300x635 mm H 605 mm h 453 mm  
seat asiento 1750x587 mm  
165 kg

**L2WS**  
2300x635 mm H 605 mm h 453 mm  
seat asiento 750x587 mm  
157 kg

Materials/Materiales:

Corten steel + WPC Plus (Wood Polymer Composite)  
Acero Corten + WPC Plus (Wood Polymer Composite)

Fixing/Fijación:

Pre-drilled for anchors  
Predisposición para tacos

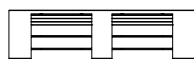
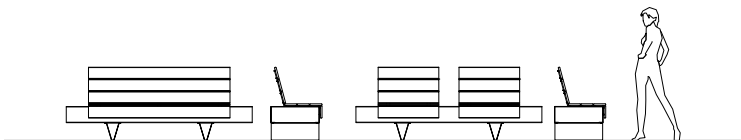





AE



AI

## NORSE AE | AI

Designer:	Massimo Tasca
Dimensions and weight Dimensiones y peso:	<p><b>AE</b> 1933x1933 mm H 453 mm seat asiento 750x462 mm 173 kg</p> <p><b>AI</b> 1900x1900 mm H 453 mm seat asiento 750x462 mm 173 kg</p>
Materials/Materiales:	Corten steel + WPC Plus (Wood Polymer Composite) Acero Corten + WPC Plus (Wood Polymer Composite)
Fixing/Fijación:	Pre-drilled for anchors Predisposición para tacos

Collection of modular benches, without backrest, composed of a "L" shape monolithic structure, made of Corten steel, with three supports. The plane is covered by two single seats in WPC (Wood Polymer Composite). Two models are available: one with seats on the outside, the other with seats on the inside.

Colección de bancos modulares, sin respaldo, formados por una estructura monolítica en forma de "L", en acero Corten dotada de tres soportes. La superficie de asiento está revestida por dos asientos monoplaza en WPC (Wood Polymer Composite). Disponibles en dos modelos: uno con asientos en el lado externo, otro con asientos en el lado interno.

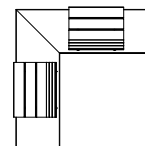
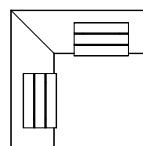
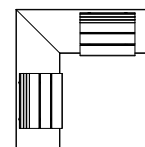
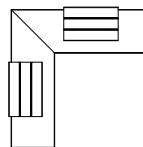
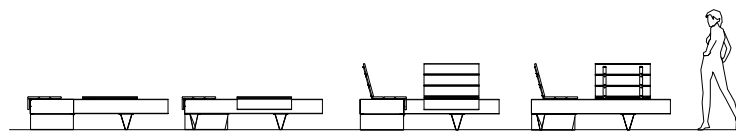



A21



A2E



L



A

#### NORSE A21 | NORSE A2E

Collection of modular benches composed of a "L" shape monolithic structure, made of Corten steel, with three supports. The plane is covered by two single seats in WPC (Wood Polymer Composite). Two models are available: one with seats on the outside, the other with seats on the inside.

#### NORSE L | NORSE A

Collection of modular benches, without backrest, composed of a monolithic structure, made of Corten steel, equipped with two or three supports. Two models are available: one linear, the other "L" shaped.

#### NORSE A21 | NORSE A2E

Colección de bancos modulares formados por una estructura monolítica en forma de "L", en acero Corten dotada de tres soportes. La superficie de asiento esta revestida por dos asientos con respaldoo en WPC (Wood Polymer Composite). Disponibles dos modelos: uno con asientos en el lado externo, otro con asientos en el lado interno.

#### NORSE L | NORSE A

Colección de bancos modulares, sin respaldo, formados por una estructura monolítica en acero Corten dotada de dos o tres soportes. Disponibles dos modelos: uno lineal, el otro a "L".

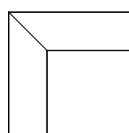
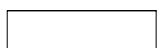
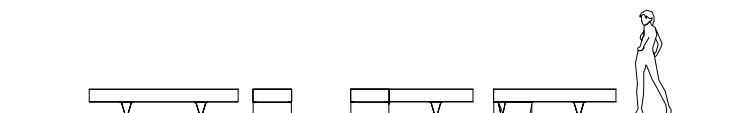

### NORSE A21 | A2E | L | A

Designer:	Massimo Tasca
Dimensions and weight Dimensiones y peso:	<p><b>A21 - A2E</b> 1900x1900 mm H 906 mm h 453 mm seat asiento 750x587 mm 200 kg</p> <p><b>L</b> 2300x600 mm H 420 mm 98 kg</p> <p><b>A</b> 1900x1900 mm H 420 mm 140 kg</p>
Materials/Materiales:	<p>Corten steel + WPC Plus (Wood Polymer Composite) Acero Corten + WPC Plus (Wood Polymer Composite)</p>
Fixing/Fijación:	<p>Pre-drilled for anchors Predisposición para tacos</p>

NORSE







FORESTA

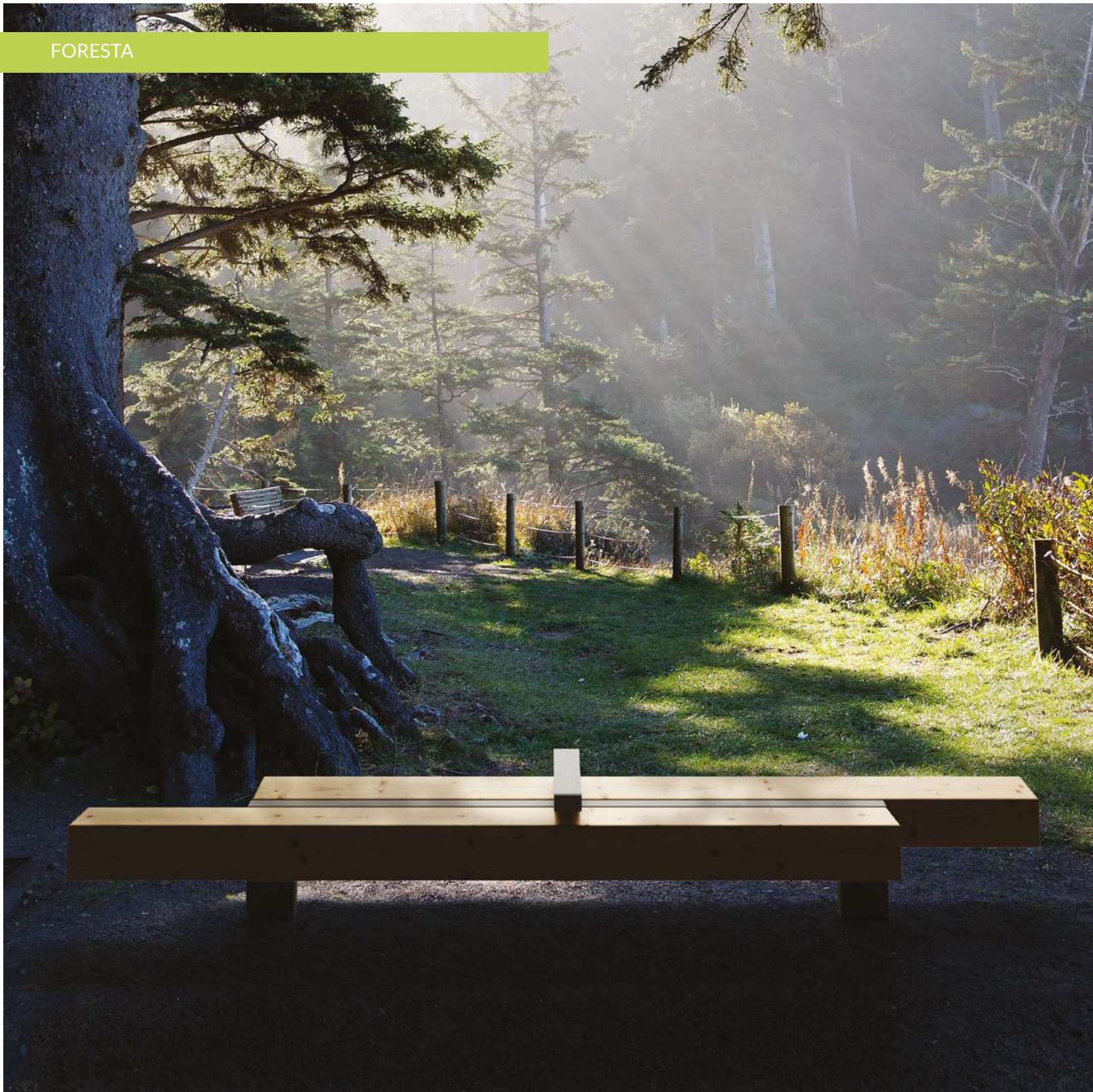



**MDO** | **MONTECARLO**  
2019 **PRIZE**

**GOOD  
DESIGN**



Collection of benches with central armrest and steel supporting structure, composed of a seat made of two longitudinal beams in glulam larch wood, slightly inclined towards the center to allow the outflow of water. Two versions are available: one with offset beams and one with aligned beams. The latter can be used as both a bench and a bike rack.

Colección de bancos, con apoyabrazos central y estructura portante en acero, formados por un elemento que sirve de asiento compuesto por dos vigas longitudinales en madera laminar en alerce, ligeramente inclinados hacia el centro para permitir la salida del agua. Disponible en dos versiones: con vigas escalonadas o alineadas. Esta segunda versión permite que el asiento se pueda utilizar también como aparcabicicletas.

## FORESTA

Designer:	Massimo Tasca
Dimensions and weight Dimensiones y peso:	3000x450 mm h 424 mm (+200 mm) 180 kg
	3580x450 mm h 424 mm (+200 mm) 183 kg
Materials/Materiales:	Larch + Powder coated steel Alerce + Acero pintado
Fixing/Fijación:	Pre-drilled for anchors or Below ground installation Predisposición para tacos o Cimentación

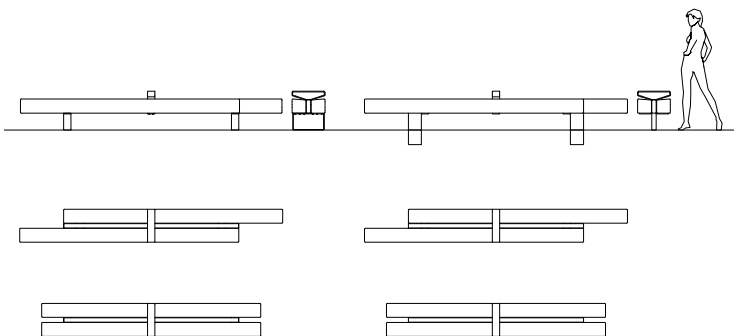



SARAH



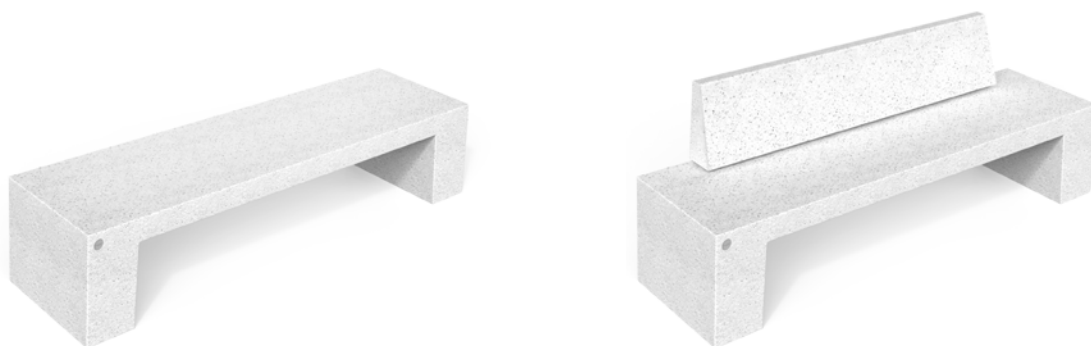

Collection of bridge-shaped benches made of PDM (Reconstituted Stones).  
Two versions, with or without backrest, are available.

Colección de bancos a forma de puente, en PDM (Piedras Reconstituidas).  
Disponible en dos versiones, con o sin respaldo.

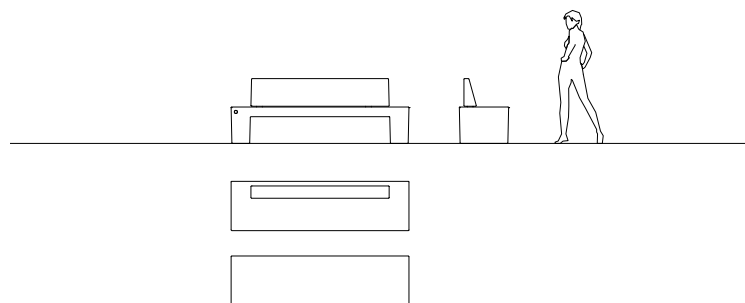

## SARAH

Designer:	Raffaele Lazzari
Dimensions and weight Dimensiones y peso:	2200x605 mm H 800 mm h 450 mm 733 kg
	2200x605 mm h 450 mm 600 kg
Materials/Materiales:	PDM (Reconstituted Stones) PDM (Piedras Reconstituidas)
Finishes/Acabados:	Brushed top + Sandblasted sides Parte superior trabajada con púas rígidas + Laterales tratados con chorro de arena
Fixing/Fijación:	Freestanding Apoyo

GAIA

BENCHES

ASSEMBLADOS





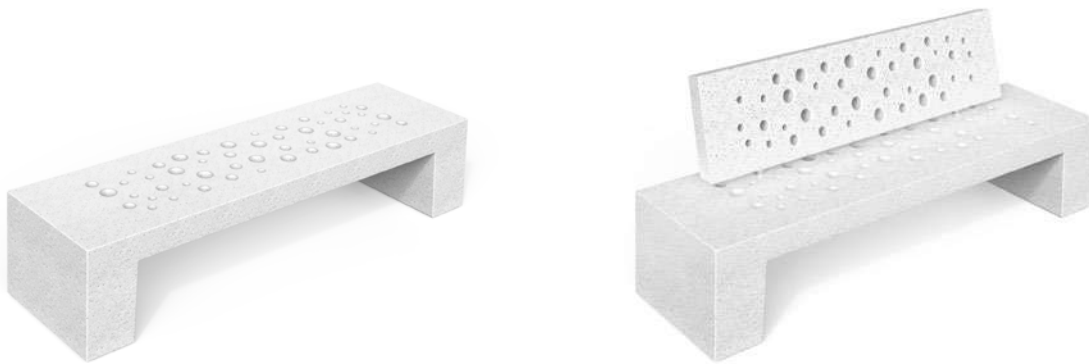

Collection of bridge-shaped bench made of HPC (High Performance Concrete) with seat decorated with holes of different sizes. Two versions are available: with or without backrest, also decorated with holes.

Colección de bancos con forma de puente, en HPC (High Performance Concrete) con asiento decorado con orificios de diferentes tamaños. Disponible en dos versiones, con o sin respaldo, decorado también con orificios.

## GAIA

Designer:	Metalco Design
Dimensions and weight Dimensiones y peso:	2200x610 mm H 905 mm h 450 mm 720 kg
	2200x610 mm H 450 mm 570 kg
Materials/Materiales:	HPC (High Performance Concrete)
Finishes/Acabados:	Velluto - Natural smooth Velluto - Liso natural
Fixing/Fijación:	Freestanding Apoyo

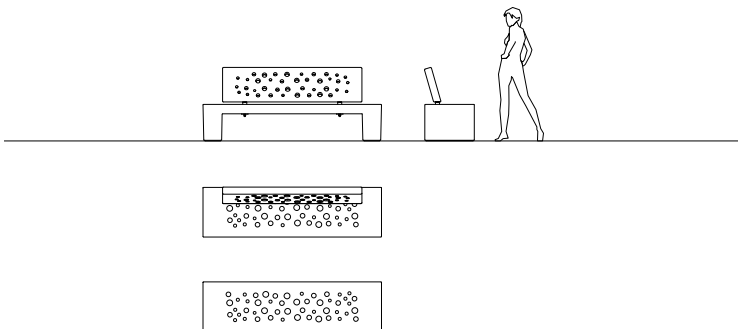

GAIA

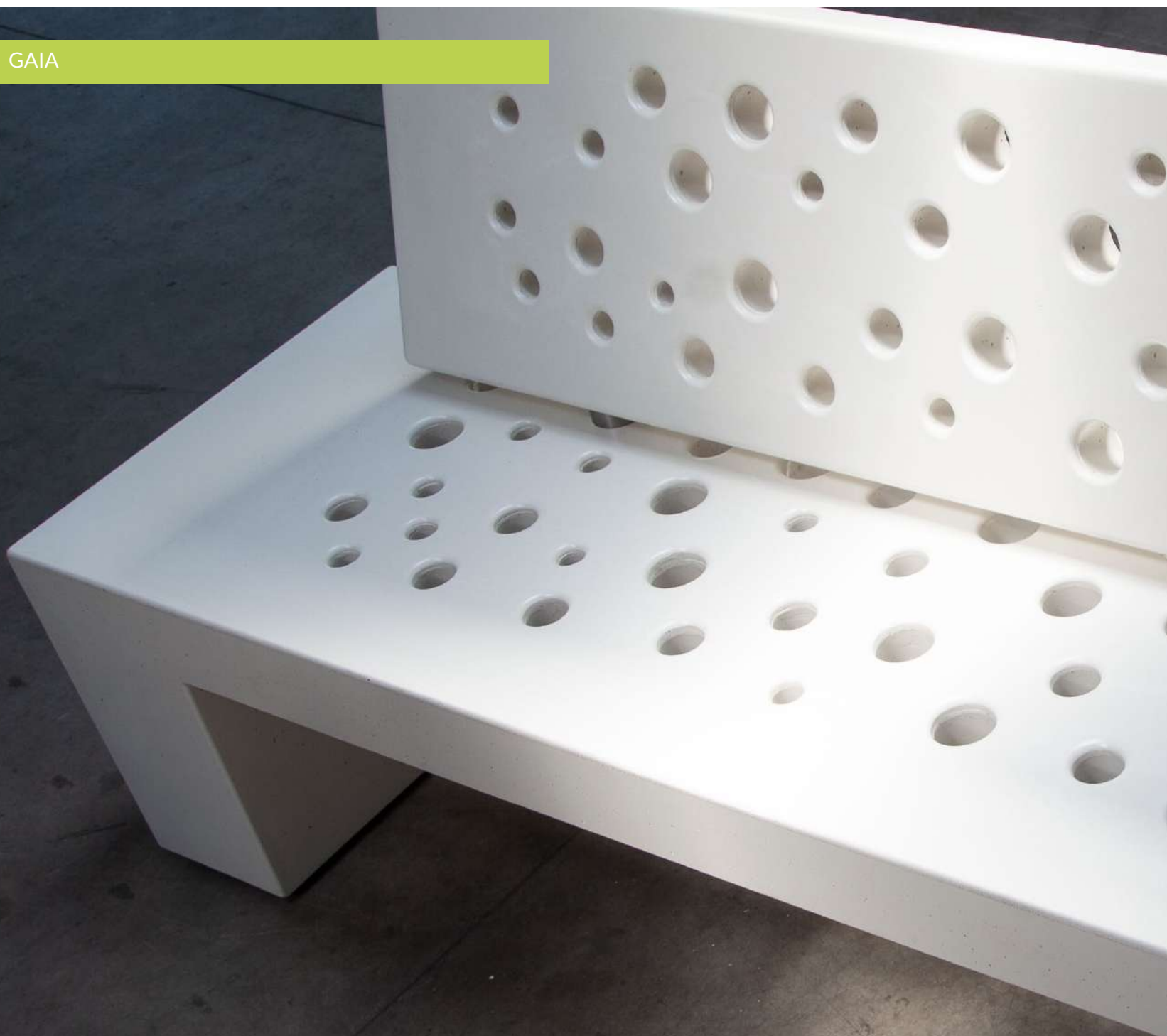

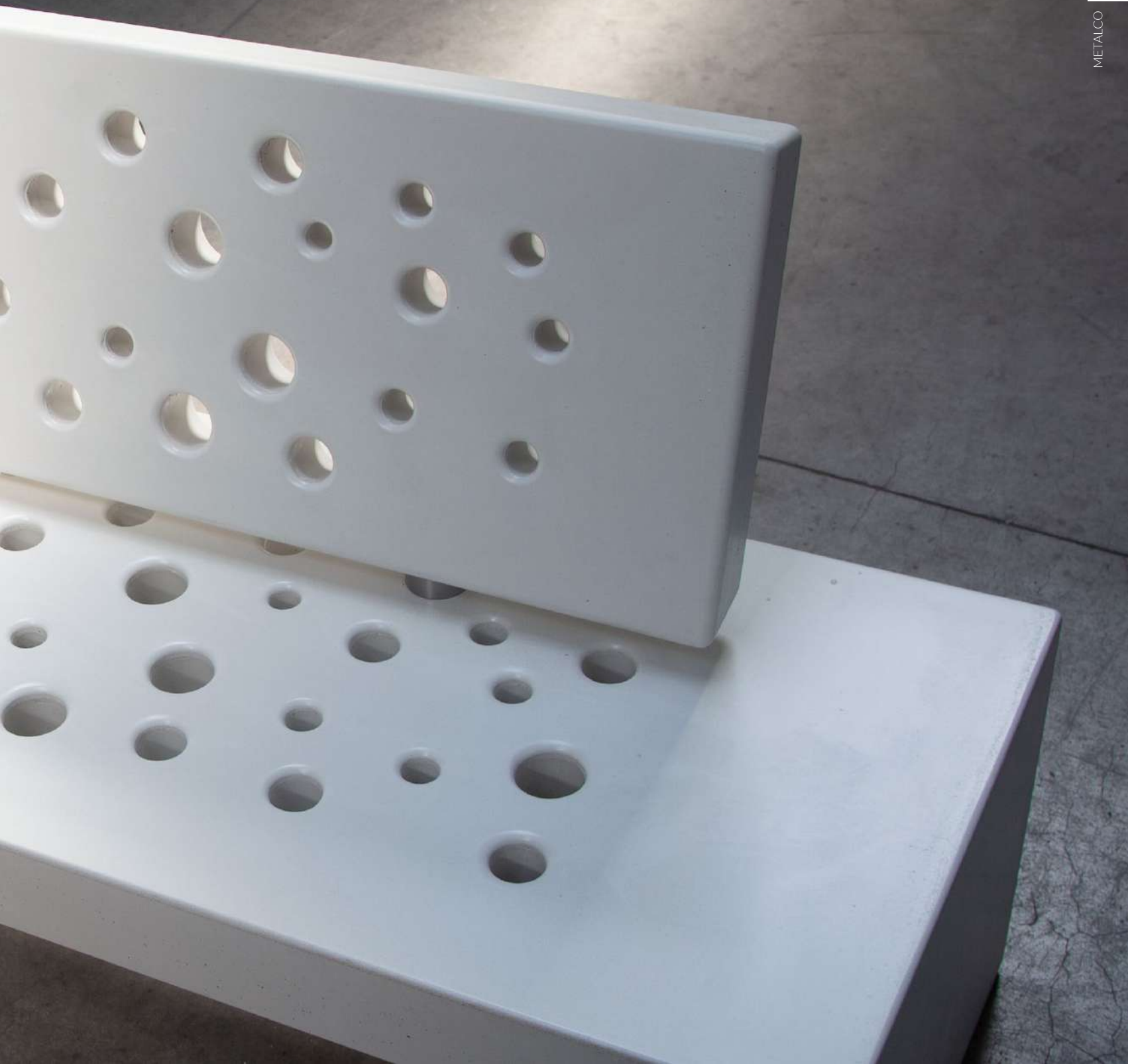



HARRIS WOOD COLLECTION

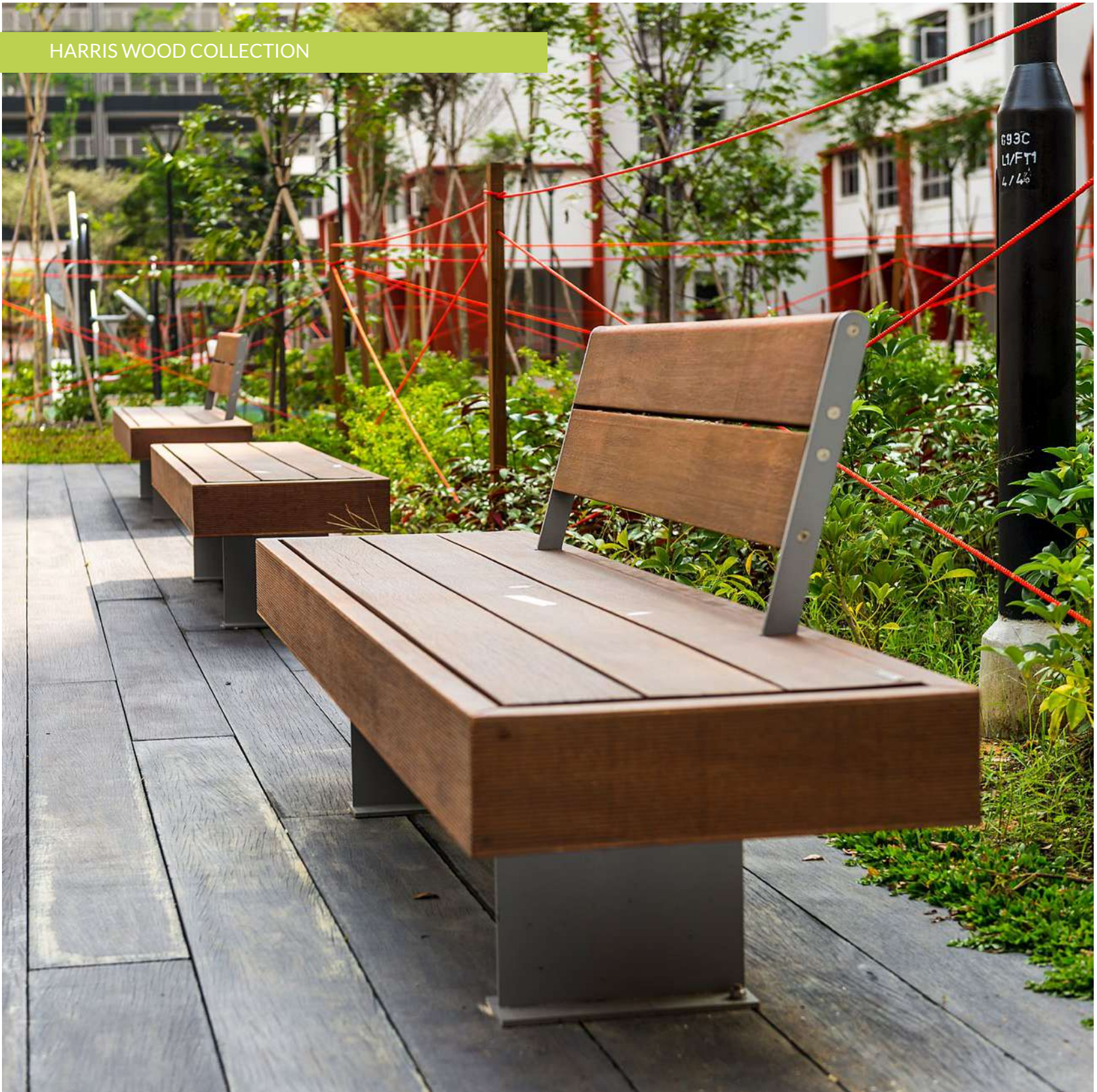

VERSION A



VERSION B







H 200



H 300

## HARRIS WOOD H 200 | H 300

Designer:	Sjit	
Dimensions and weight Dimensiones y peso:	H 200 2076x504 mm H 420 mm	69 kg
	H 300 3076x504 mm H 420 mm	100 kg
Materials/Materiales:	Powder coated steel or Corten steel + Hardwood Acero pintado o Acero Corten + Madera dura	
Fixing/Fijación:	Pre-drilled for anchors Predisposición para tacos	

Collection of modular seats composed of steel supports, a wooden perimeter frame, a seat, made of full length wooden slats (version B) or staggered joints (version A). Two sizes, with or without wooden backrest, are available. The H 300 version is also available with alternating backrest.

Colección de bancos modulares formados de soportes en acero, de una estructura perimetral de madera, de una superficie que sirve de asiento, realizado con listones enteros de madera (versión B) o con listones escalonados (versión A). Disponibles dos tamaños, con o sin respaldo de madera. La versión H 300 está disponible con respaldo alterno.





HS 200



H2S 300



HSC 300

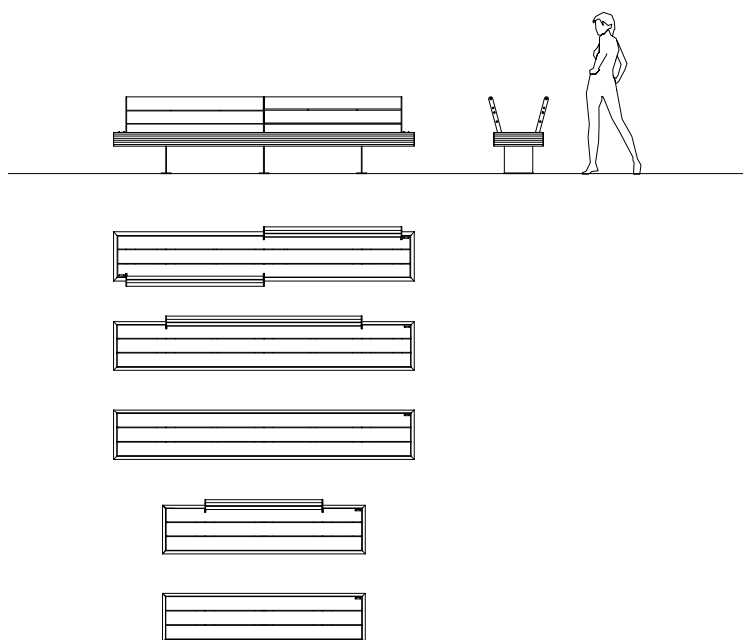

## HARRIS WOOD HS 200 | H2S 300 | HSC 300

Designer:	Sjit				
Dimensions and weight Dimensiones y peso:	<p>HS 200 2076x504 mm H 790 mm h 420 mm 78 kg</p> <p>H2S 300   HSC 300 3076x504 mm H 790 mm h 420 mm</p> <table border="0"> <tr> <td>H2S300</td> <td>118 kg</td> </tr> <tr> <td>HSC300</td> <td>140 kg</td> </tr> </table>	H2S300	118 kg	HSC300	140 kg
H2S300	118 kg				
HSC300	140 kg				
Materials/Materiales:	Powder coated steel or Corten steel + Hardwood Acero pintado o Acero Corten + Madera dura				
Fixing/Fijación:	Pre-drilled for anchors Predisposición para tacos				

BIG HARRIS WOOD





BH 1076

BH 2076

BH 3076

BH 4076

Collection of benches, without backrest, composed of steel supports, a double perimeter frame in wood, a seat, made of full length wooden slats (version B) or staggered joints (version A). Four different lengths are available.

Colección de bancos sin respaldo, formado por soportes en acero, con una doble estructura perimetral en madera y por una superficie que hace de asiento, realizada con listones de madera enteros (versión B) o con listones escalonados (versión A). Disponible en cuatro largos.

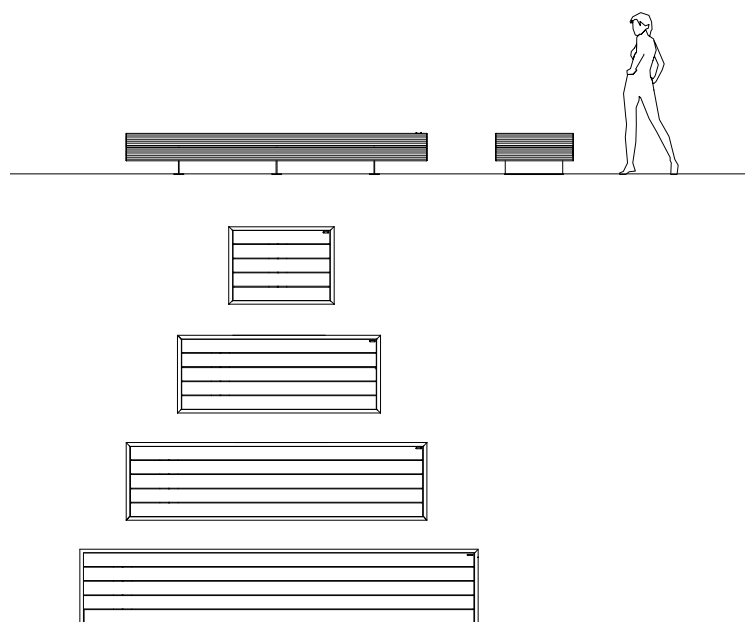

## BIG HARRIS WOOD

Designer:	Sjit								
Dimensions and weight: Dimensiones y peso:	<table border="0"> <tbody> <tr> <td>BH 1076 1076x794 mm H 420 mm</td> <td>96 kg</td> </tr> <tr> <td>BH 2076 2076x794 mm H 420 mm</td> <td>145 kg</td> </tr> <tr> <td>BH 3076 3076x794 mm H 420 mm</td> <td>197 kg</td> </tr> <tr> <td>BH 4076 4076x794 mm H 420 mm</td> <td>253 kg</td> </tr> </tbody> </table>	BH 1076 1076x794 mm H 420 mm	96 kg	BH 2076 2076x794 mm H 420 mm	145 kg	BH 3076 3076x794 mm H 420 mm	197 kg	BH 4076 4076x794 mm H 420 mm	253 kg
BH 1076 1076x794 mm H 420 mm	96 kg								
BH 2076 2076x794 mm H 420 mm	145 kg								
BH 3076 3076x794 mm H 420 mm	197 kg								
BH 4076 4076x794 mm H 420 mm	253 kg								
Materials/Materiales:	Powder coated steel or Corten steel + Hardwood Acero pintado o Acero Corten + Madera dura								
Fixing/Fijación:	Pre-drilled for anchors Predisposición para tacos								



HARRIS ISOLA + HARRIS TREE WOOD





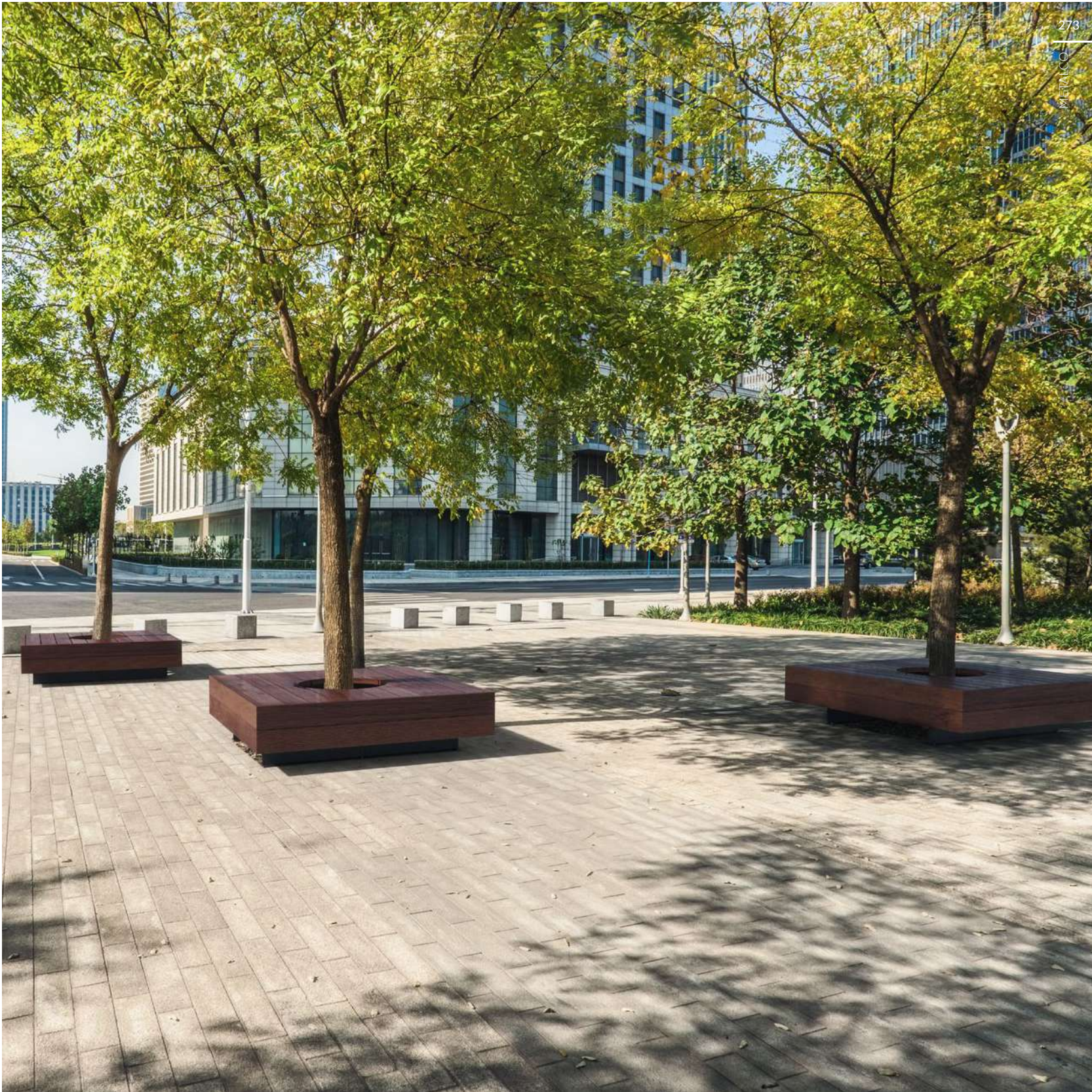



HARRIS ISOLA WOOD







HI 1576



HI 2076



HI 1550



H TREE

Collection of modular seats, without backrest, composed of a double perimeter frame and a seat, both made of full length wooden slats. Four versions are available: two square seats of different sizes; a seat with a central hole for the positioning around trees or plants; a "L" shaped seat, compatible with the Big Harris collection. The seats can be installed individually or in composition.

Colección de bancos modulares, sin respaldo, formados de una doble estructura perimetral de madera y de una superficie que sirve de asiento, realizadas con listones de madera enteros. Disponibles en cuatro versiones: dos bancos de forma cuadrada con diferentes tamaños; un banco dotado con un orificio central para poder plantar un árbol o una planta; un banco a forma de "L", compatible con la colección Big Harris. Los bancos pueden ser instalados individualmente o en una composición.

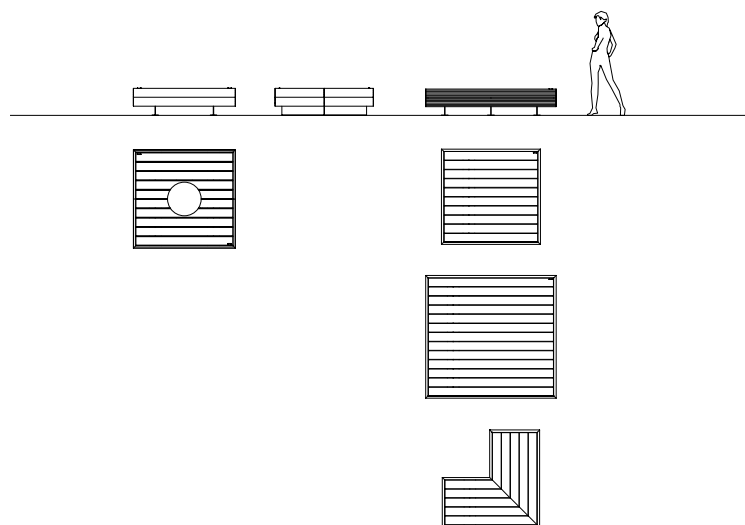

## HARRIS ISOLA + HARRIS TREE WOOD

Designer:	Sjit								
Dimensions and weight Dimensiones y peso:	<table border="0"> <tbody> <tr> <td>HI 1576 1576x1519 mm H 420 mm</td> <td>220 kg</td> </tr> <tr> <td>HI 2076 2076x1954 mm H 420 mm</td> <td>376 kg</td> </tr> <tr> <td>HI 1550 1550x1550 mm H 420 mm</td> <td>185 kg</td> </tr> <tr> <td>H TREE 1576x1519 mm H 420 mm</td> <td>200 kg</td> </tr> </tbody> </table>	HI 1576 1576x1519 mm H 420 mm	220 kg	HI 2076 2076x1954 mm H 420 mm	376 kg	HI 1550 1550x1550 mm H 420 mm	185 kg	H TREE 1576x1519 mm H 420 mm	200 kg
HI 1576 1576x1519 mm H 420 mm	220 kg								
HI 2076 2076x1954 mm H 420 mm	376 kg								
HI 1550 1550x1550 mm H 420 mm	185 kg								
H TREE 1576x1519 mm H 420 mm	200 kg								
Materials/Materiales:	Powder coated steel or Corten steel + Hardwood Acero pintado o Acero Corten + Madera dura								
Fixing/Fijación:	Pre-drilled for anchors Predisposición para tacos								

HARRIS WPC COLLECTION

BENCHES

ASIENTOS





[www.metalco.it](http://www.metalco.it)  
+39 0423 7863





WH 200



WH 300

## HARRIS WPC WH 200 | WH 300

Designer:	Sjit	
Dimensions and weight Dimensiones y peso:	<b>WH 200</b> 2050x555 mm H 420 mm	90 kg
	<b>WH 300</b> 3050x555 mm H 420 mm	135 kg
Materials/Materiales:	Powder coated steel or Corten steel + WPC Plus (Wood Polymer Composite) Acero pintado o Acero Corten + WPC Plus (Wood Polymer Composite)	
Fixing/Fijación:	Pre-drilled for anchors Predisposición para tacos	

Collection of modular seats composed of steel supports, a perimeter frame, a seat, both made of WPC (Wood Polymer Composite). Two sizes, with or without backrest, are available. The WH 300 version is also available with alternating backrest.

Colección de asientos modulares, formados por soportes de acero, de una estructura perimetral, de una superficie que sirve de asiento, realizado en WPC (Wood Polymer Composite). Disponibles dos tamaños, con o sin respaldo. La versión WH 300 está disponible con respaldo alterno.



WHS 200



WH2S 300



WHSC 300

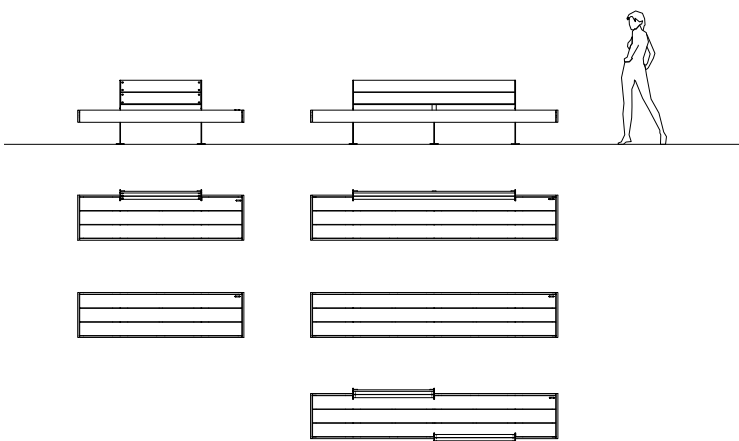

### HARRIS WPC WHS 200 | WH2S 300 | WHSC 300

Designer:	Sjit						
Dimensions and weight Dimensiones y peso:	<table border="0"> <tbody> <tr> <td><b>WHS 200</b> 2050x620 mm H 790 mm h 420 mm</td> <td>100 kg</td> </tr> <tr> <td><b>WHS 300</b> 3050x620 mm H 790 mm h 420 mm</td> <td>155 kg</td> </tr> <tr> <td><b>WHSC 300</b> 3050x685 mm H 790 mm h 420 mm</td> <td>160 kg</td> </tr> </tbody> </table>	<b>WHS 200</b> 2050x620 mm H 790 mm h 420 mm	100 kg	<b>WHS 300</b> 3050x620 mm H 790 mm h 420 mm	155 kg	<b>WHSC 300</b> 3050x685 mm H 790 mm h 420 mm	160 kg
<b>WHS 200</b> 2050x620 mm H 790 mm h 420 mm	100 kg						
<b>WHS 300</b> 3050x620 mm H 790 mm h 420 mm	155 kg						
<b>WHSC 300</b> 3050x685 mm H 790 mm h 420 mm	160 kg						
Materials/Materiales:	Powder coated steel or Corten steel + WPC Plus (Wood Polymer Composite) Acero pintado o Acero Corten + WPC Plus (Wood Polymer Composite)						
Fixing/Fijación:	Pre-drilled for anchors Predisposición para tacos						



WBH 100

WBH 200

WBH 300

WBH 400

## BIG HARRIS WPC COLLECTION

Designer: **Sjit**

Dimensions and weight  
Dimensiones y peso:

**WBH 100**  
1050x725 mm H 420 mm  
100 kg

**WBH 200**  
2050x725 mm H 420 mm  
140 kg

**WBH 300**  
3050x725 mm H 420 mm  
210 kg

**WBH 400**  
4050x725 mm H 420 mm  
270 kg

Materials/Materiales:  
Powder coated steel or Corten steel +  
WPC Plus (Wood Polymer Composite)  
Acero pintado o Acero Corten +  
WPC Plus (Wood Polymer Composite)

Fixing/Fijación:  
Pre-drilled for anchors  
Predisposición para tacos

Collection of benches, without backrest, composed of steel supports, a double perimeter frame and a seat, made of WPC (Wood Polymer Composite). Four different lengths are available.

Colección de bancos sin respaldo, constituidos de soportes en acero, con una doble estructura perimetral en madera y de una superficie que hace de asiento, realizada en WPC (Wood Polymer Composite). Disponible en cuatro largos.

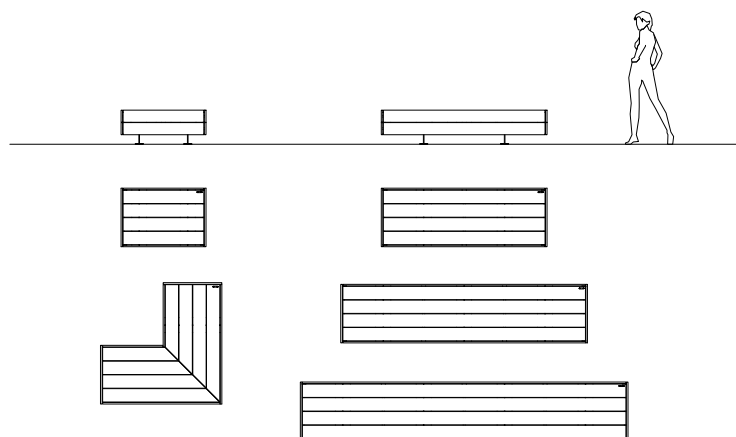





WHIA 1500



WHI 2000



WHI 1550



WH TREE

Collection of modular seats, without backrest, composed of a double perimeter frame and a seat, both made of WPC (Wood Polymer Composite). Four versions are available: two square seats of different sizes; a seat with a central hole for the positioning around trees or plants; a "L" shaped seat, compatible with the Big Harris collection. The seats can be installed individually or in composition.

Colección de asientos modulares, sin respaldo, formados de una doble estructura perimetral de madera y de una superficie que sirve de asiento, realizadas en WPC (Wood Polymer Composites). Disponibles en cuatro versiones: dos bancos de forma cuadrada con diferentes tamaños; un banco dotado con un orificio central para poder plantar un árbol o una planta, un banco en forma de "L", compatible con la colección Big Harris. Los asientos pueden ser instalados individualmente o en una composición.

## HARRIS ISOLA WPC COLLECTION

Designer:	Sjit
Dimensions and weight Dimensiones y peso:	<p><b>WHIA 1500</b> 1500x1500 mm H 420 mm 175 kg</p> <p><b>WHI 1550</b> 1550x1410 mm H 420 mm 210 kg</p> <p><b>WHI 2000</b> 2050x1915 mm H 420 mm 370 kg</p> <p><b>WH TREE</b> 1550x1410 mm H 420 mm 220 kg</p>
Materials/Materiales:	Powder coated steel or Corten steel + WPC Plus (Wood Polymer Composite) Acero pintado o Acero Corten + WPC Plus (Wood Polymer Composite)
Fixing/Fijación:	Pre-drilled for anchors Predisposición para tacos

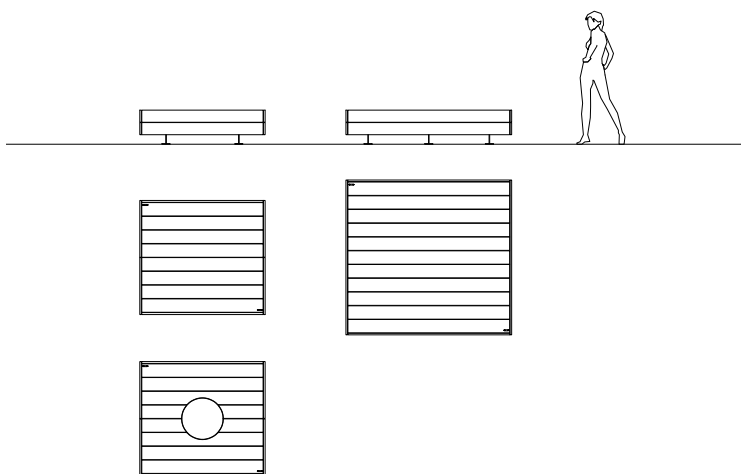

HARRIS ISOLA TRAPEZIO WPC

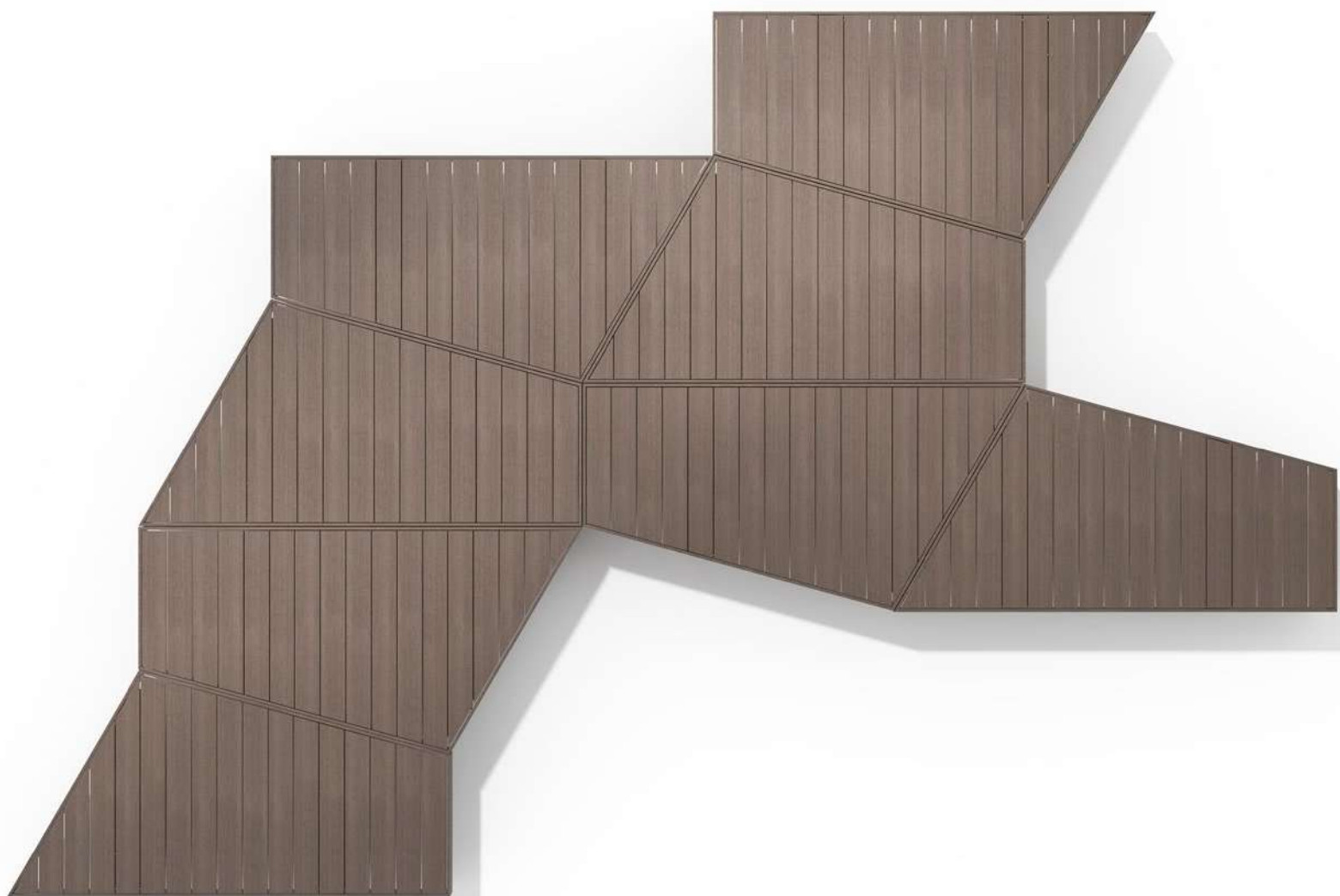



Trapezoidal modular seat, without backrest, composed of a double perimeter frame and a seat, both made of WPC (Wood Polymer Composite). The seats can be installed individually or in composition.

Asiento modular con forma trapezoidal, sin respaldo, formado por una doble estructura perimetral y por una superficie que sirve de asiento, realizados en WPC (Wood Polymer Composites). Los asientos pueden ser instalados individualmente o en una composición.

## HARRIS ISOLA TRAPEZIO WPC

Designer:	Metalco Design
Dimensions and weight Dimensiones y peso:	2970x1520 mm H 420 mm 370 kg
Materials/Materiales:	Powder coated steel or Corten steel + WPC Plus (Wood Polymer Composite) Acero pintado o Acero Corten + WPC Plus (Wood Polymer Composite)
Fixing/Fijación:	Pre-drilled for anchors Predisposición para tacos

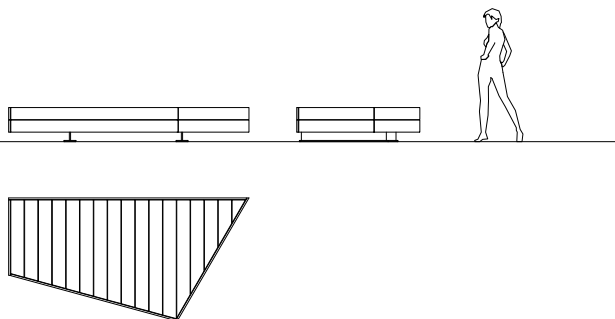



BIG HARRIS WPC









HORN







Collection of benches composed of two supports in powder coated cast aluminum and a steel frame that supports a wooden seat. They are available with or without wooden backrest.

Colección de bancos formados por dos soportes en fundición de aluminio pintado y por una estructura en acero que sujeta una superficie de madera que sirve de asiento. Disponible con o sin respaldo de madera.

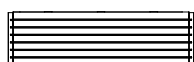
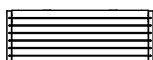
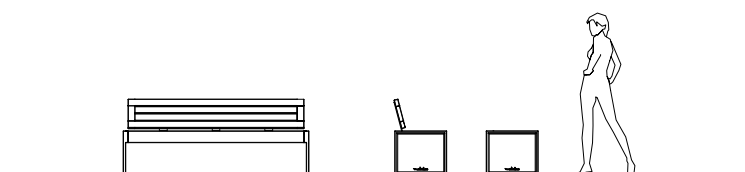

## HORN

Designer:	Metalco Design						
Dimensions and weight Dimensiones y peso:	<table border="0"> <tr> <td>1900x532 mm H 775 mm h 450 mm</td> <td></td> </tr> <tr> <td>Hardwood   Madera dura</td> <td>56   78 kg</td> </tr> <tr> <td>Larch   Alerce</td> <td>44   57 kg</td> </tr> </table>	1900x532 mm H 775 mm h 450 mm		Hardwood   Madera dura	56   78 kg	Larch   Alerce	44   57 kg
1900x532 mm H 775 mm h 450 mm							
Hardwood   Madera dura	56   78 kg						
Larch   Alerce	44   57 kg						
	<table border="0"> <tr> <td>1500x532 mm H 775 mm h 450 mm</td> <td></td> </tr> <tr> <td>Hardwood   Madera dura</td> <td>34   56 kg</td> </tr> <tr> <td>Larch   Alerce</td> <td>30   44 kg</td> </tr> </table>	1500x532 mm H 775 mm h 450 mm		Hardwood   Madera dura	34   56 kg	Larch   Alerce	30   44 kg
1500x532 mm H 775 mm h 450 mm							
Hardwood   Madera dura	34   56 kg						
Larch   Alerce	30   44 kg						
Materials/Materiales:	Hardwood or Larch + Powder coated aluminum Madera dura o Alerce + Aluminio pintado						
Fixing/Fijación:	Installation with threaded bars Cimentación con varillas roscadas						



## IDEAS L

Designer:	Alfredo Tasca
Dimensions and weight Dimensiones y peso:	2890x452 mm H 812 mm h 440 mm
	Hardwood   Madera dura 196   160 kg Larch   Alerce 157   128 kg
	backrest   respaldo 1320 mm
	Hardwood   Madera dura 18 kg Larch   Alerce 14 kg
	1990x452 mm H 812 mm h 440 mm
	Hardwood   Madera dura 138   110 kg Larch   Alerce 120   96 kg
	backrest   respaldo 1490 mm
	Hardwood   Madera dura 21 kg Larch   Alerce 16 kg
Materials/Materiales:	Powder coated steel or Corten steel + Hardwood or Larch wood Acero pintado o Madera dura + Alerce
Fixing/Fijación:	Pre-drilled for anchors Predisposición para tacos
Accessories/Accesorios:	Ground fixing kit Kit de fijación au sol  Armrests Apoyabrazos



Collection of benches composed of a seat made of wooden slats, positioned vertically and connected to each other through a steel connecting bar, with stainless steel ends and two steel supports. Two sizes, with or without backrest, are available.

Colección de bancos formado por un asiento compuesto de listones de madera, posicionados verticalmente, conectados entre sí por una barra de conexión en acero, con terminales de acero Inoxidable y dos soportes de acero. Disponible en dos tamaños, con o sin respaldo.

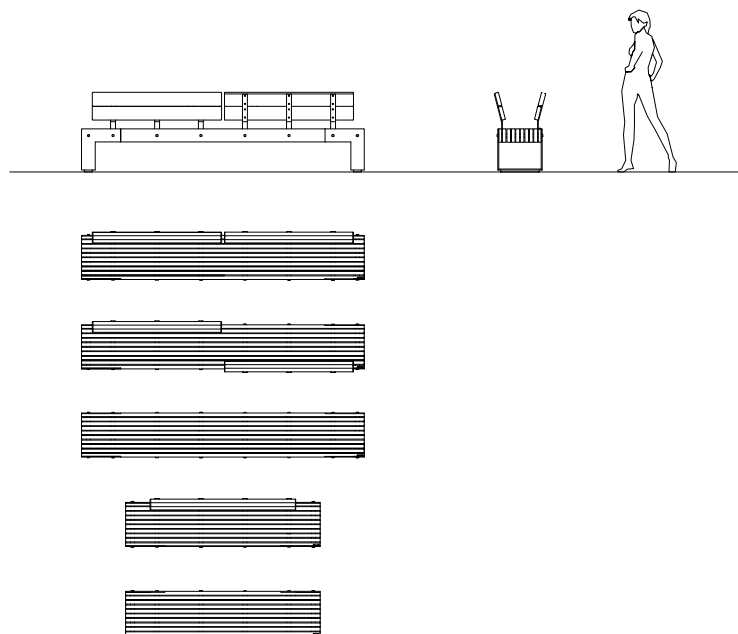



Collection of benches composed of a seat made of wooden slats, positioned vertically and connected to each other through a steel connecting bar, with stainless steel ends and one steel support. Two sizes are available.

Colección de bancos constituidos por un asiento formado de listones de madera posicionados verticalmente, conectados entre sí por una barra de conexión en acero, con terminales de acero Inoxidable y de un soporte de acero. Disponible en dos tamaños.

## IDEAS T

Designer:	Alfredo Tasca		
Dimensions and weight Dimensiones y peso:	2840x452 mm h 440 mm		
	Hardwood   Madera dura	182 kg	
	Larch   Alerce	146 kg	
	1940x452 mm h 440 mm		
	Hardwood   Madera dura	120 kg	
	Larch   Alerce	96 kg	
Materials/Materiales:	Powder coated steel or Corten steel + Hardwood or Larch wood Acero pintado o Acero Corten + Madera dura o Alerce		
Fixing/Fijación:	Anchors Tacos		

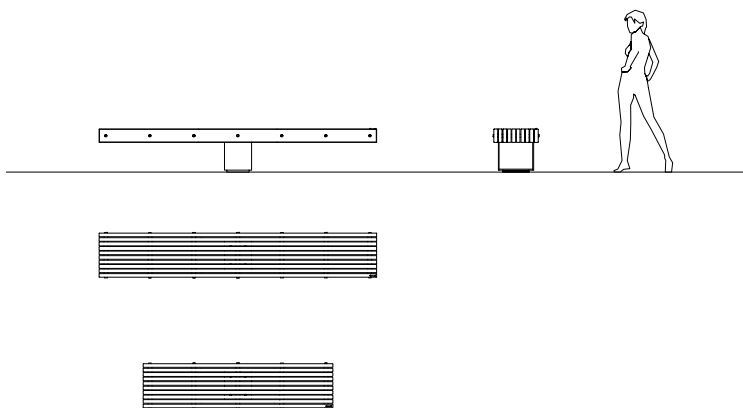



DELTA







DELTA









## DELTA F

Designer:	Uwe Kuckertz	
Dimensions and weight Dimensiones y peso:	995x990 mm H 440 mm	560 kg
	2000x990 mm H 440 mm	1260 kg
Materials/Materiales:	HPC (High Performance Concrete)	
Finishes/Acabados:	Velluto - Natural smooth Velluto - Liso natural	
Fixing/Fijación:	Freestanding Apoyo	

Collection of modular benches in HPC (High Performance Concrete) composed of a base module and a composition module, equipped with a double-sided seat. Both modules are available with planter or with backrest in HPC (High Performance Concrete).

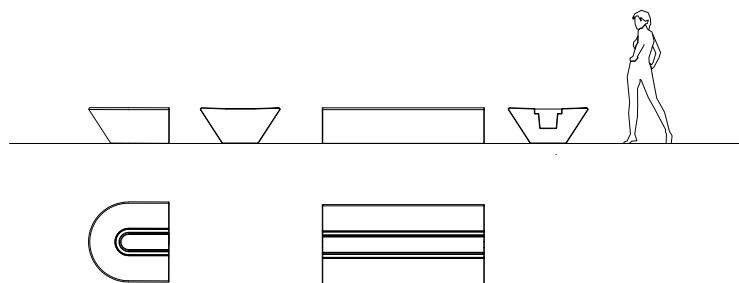



Colección de bancos modulares en HPC (High Performance Concrete) formados por un módulo base y un módulo composición, dotados de asientos bilaterales. Ambos módulos están disponibles en versiones con jardineras en acero o con respaldo en HPC (High Performance Concrete).

## DELTA B

Designer:	Uwe Kuckertz	
Dimensions and weight	995x990 mm H 805 mm	638 kg
Dimensiones y peso:	2000x990 mm H 805 mm	
		1640 kg
Materials/Materiales:	HPC (High Performance Concrete)	
Finishes/Acabados:	Velluto - Natural smooth Velluto - Liso natural	
Fixing/Fijación:	Freestanding Apoyo	

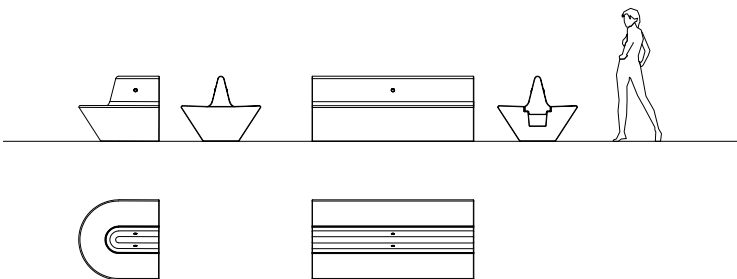



DELTA







PONTE W





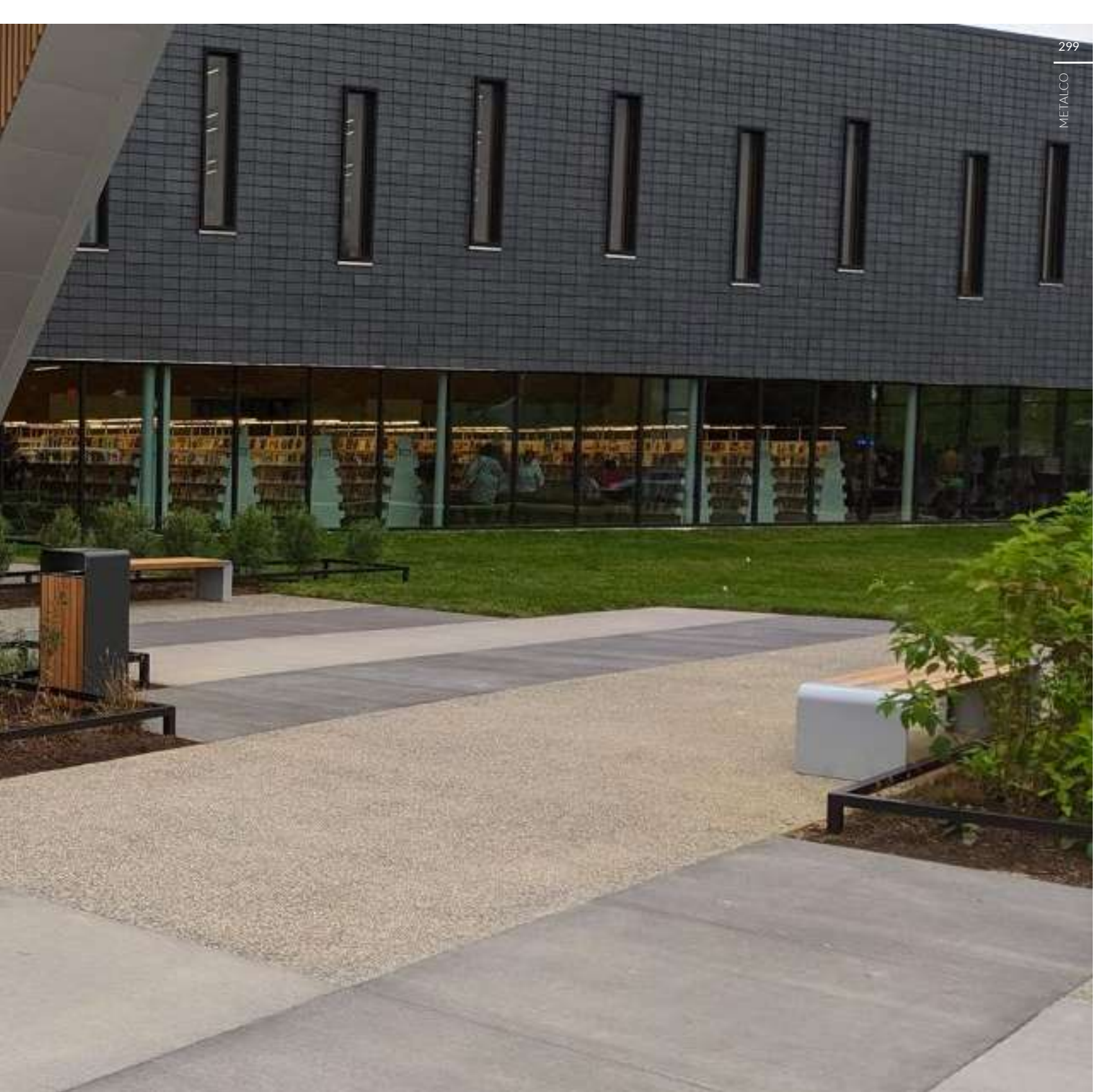







Collection of bridge-shaped benches composed of two aluminum supports with rounded corners and a wooden seat. They are available with or without wooden backrest.

Colección de bancos a forma de puente dotado de dos soportes en fundición de aluminio con ángulos redondeados y una superficie de madera que hace de asiento. Disponibles con o sin respaldo de madera.

## PONTE W

Designer:	Massimo Tasca		
Dimensions and weight Dimensiones y peso:	2015x530 mm H 460 mm		
	Hardwood   Madera dura	60 kg	
	Larch   Alerce	42 kg	
	2015x560 mm H 780 mm h 460 mm		
	Hardwood   Madera dura	70 kg	
	Larch   Alerce	52 kg	
Materials/Materiales:	Hardwood or Larch wood + Powder coated aluminum Madera dura o Meleze + Aluminio pintado		
Fixing/Fijación:	Freestanding with pedestals or Installation with threaded bars Apoyo con pies o Cimentación con varillas roscadas		

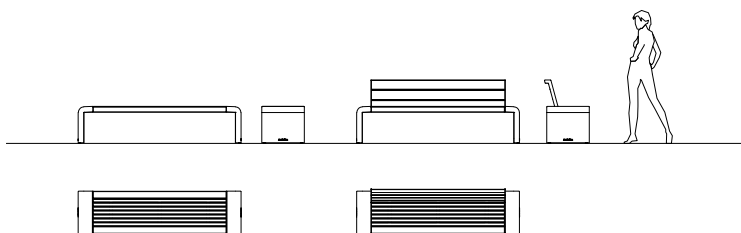



PONTE A





Bridge-shaped benches composed of two aluminum supports with rounded edges and a wooden seat in extruded aluminum.

Banco a forma de puente dotado de dos soportes en fundición de aluminio con ángulos redondeados y una superficie que hace de asiento en extrusión de aluminio.

## PONTE A

Designer:	Massimo Tasca
Dimensions and weight Dimensiones y peso:	2015x530 mm H 460 mm 43 kg
Materials/Materiales:	Powder coated aluminum Aluminio pintado
Fixing/Fijación:	Freestanding with pedestals or Installation with threaded bars Apoyo con pies o Cimentación con varillas roscadas

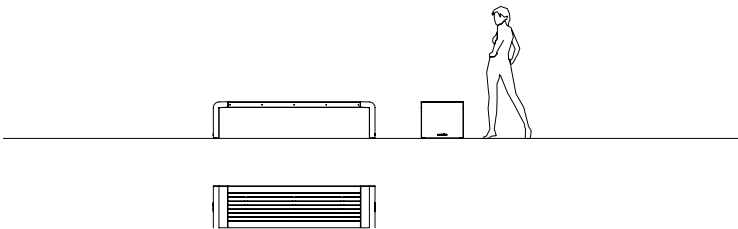



FRANK









FRANK

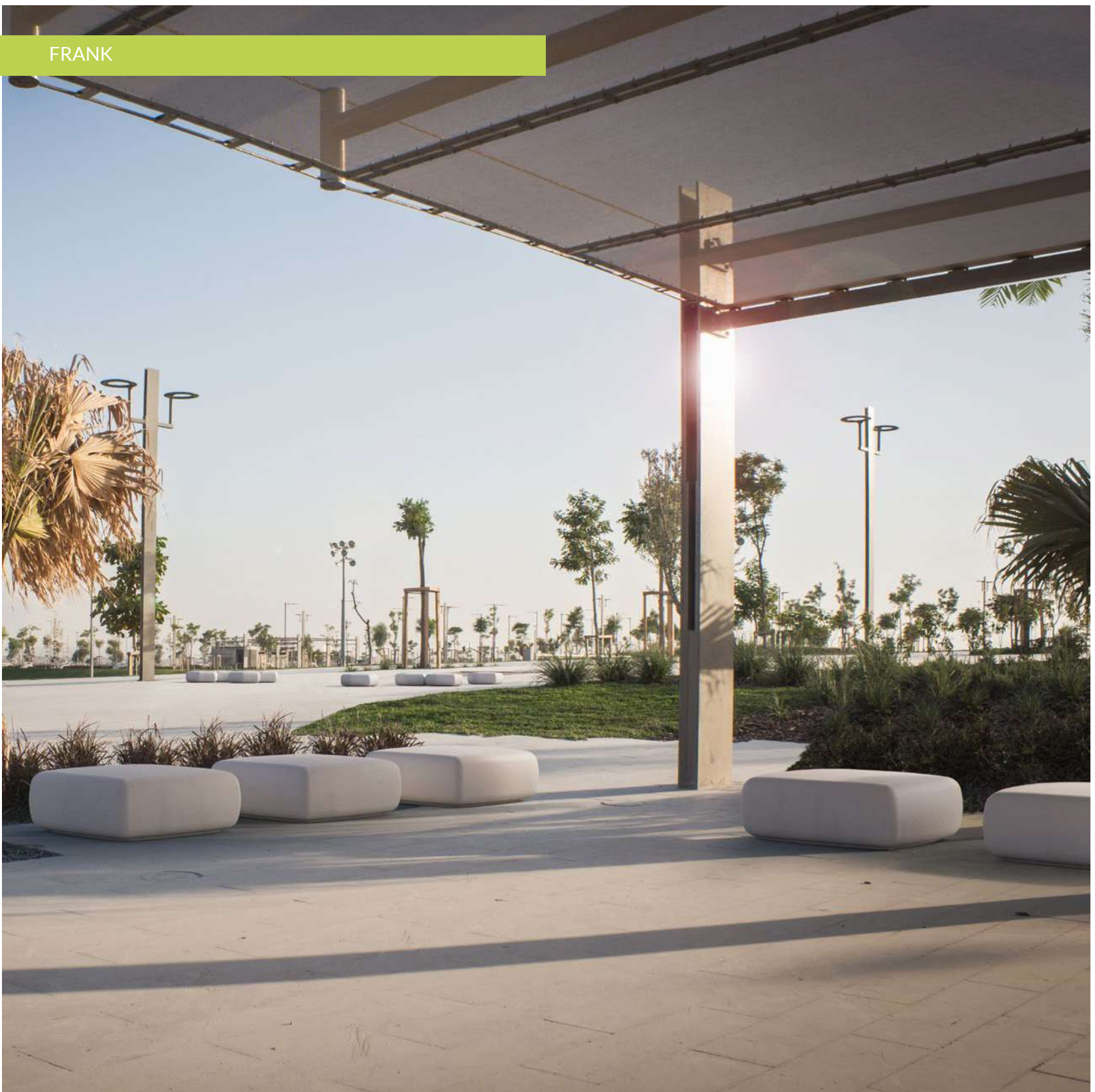

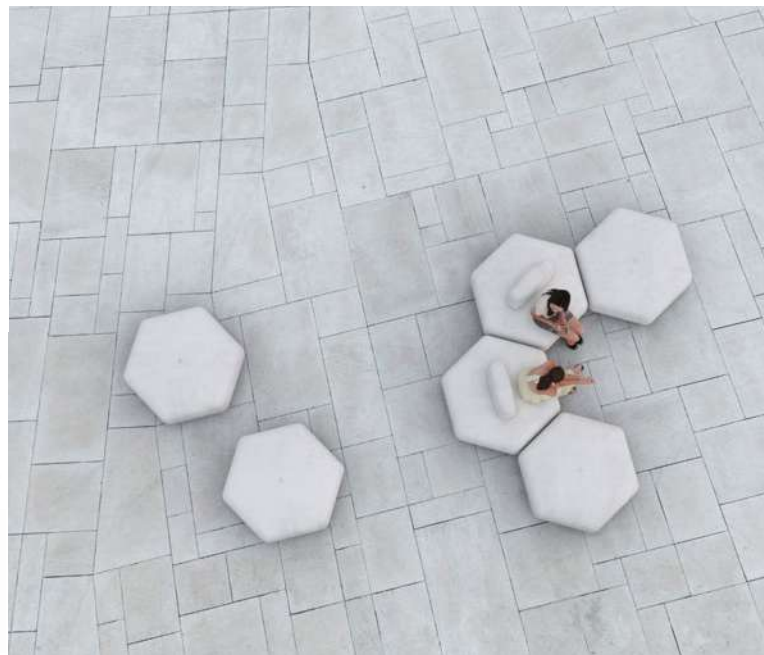

Collection of modular seats, shaped as hexagonal pouf made of HPC (High Performance Concrete), partially emptied inside. Two versions, with or without backrest in HPC (High Performance Concrete), are available. The seats can be installed individually or in composition.

Colección de asientos modulares, en forma de pouf hexagonal en HPC (High Performance Concrete), aligeradas internamente. Disponible en dos versiones, con o sin respaldo en HPC (High Performance Concrete). Los asientos pueden ser instalados individualmente o en composición.

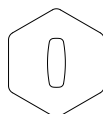
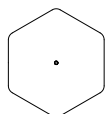
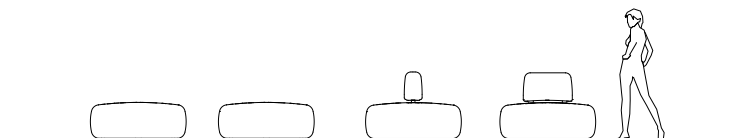

## FRANK

Designer:	Massimo Tasca
Dimensions and weight Dimensiones y peso:	1350x1350 mm H 845 mm h 470 mm with backrest   con respaldo 838 kg without backrest   sin respaldo 715 kg
Materials/Materiales:	HPC (High Performance Concrete)
Finishes/Acabados:	Velluto - Natural smooth Velluto - Liso natural
Fixing/Fijación:	Freestanding Apoyo
Accessories/Accesorios:	LED lighting Iluminación LED



## METALCO COMFORT PROGRAM

Consumption/Consumo: 0,2 kWh

Power/Potencia: 200 W

Info pag. 178



JASPER





Collection of modular seats, shaped as square pouf made of HPC (High Performance Concrete), partially emptied inside. Two versions are available, with or without backrest in HPC (High Performance Concrete). The seats can be installed individually or in composition.

Colección de asientos modulares, en forma de pouf cuadrado en HPC (High Performance Concrete), aligerados internamente. Disponible en dos versiones con o sin respaldo en HPC (High Performance Concrete). Los asientos pueden ser instalados individualmente o en una composición.

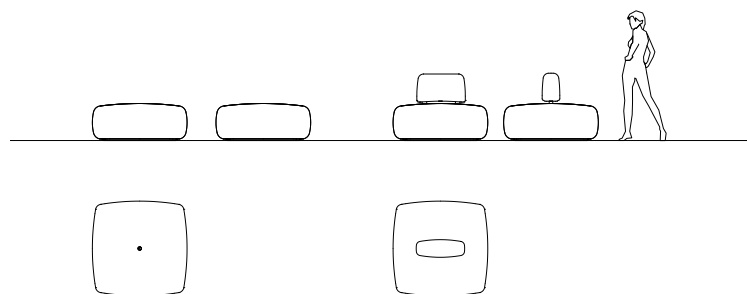

## JASPER

Designer:	Massimo Tasca
Dimensions and weight Dimensiones y peso:	1200x1200 mm H 845 mm h 470 mm with backrest   con respaldo 813 kg without backrest   sin respaldo 726 kg
Materials/Materiales:	HPC (High Performance Concrete)
Finishes/Acabados:	Velluto - Natural smooth Velluto - Liso natural
Fixing/Fijación:	Freestanding Apoyo
Accessories/Accesorios:	LED lighting Iluminación LED



## METALCO COMFORT PROGRAM

Consumption/Consumo:	0,242 kWh
Power/Potencia:	242 W

Info pag. 178



NORMAN







Collection of modular seats, shaped as circular pouf made of HPC (High Performance Concrete), partially emptied inside. Two versions are available, with or without backrest in HPC (High Performance Concrete).

Colección de asientos, con forma de pouf circular, en HPC (High Performance Concrete), aligerados internamente. Disponible en dos versiones con o sin respaldo en HPC (High Performance Concrete).

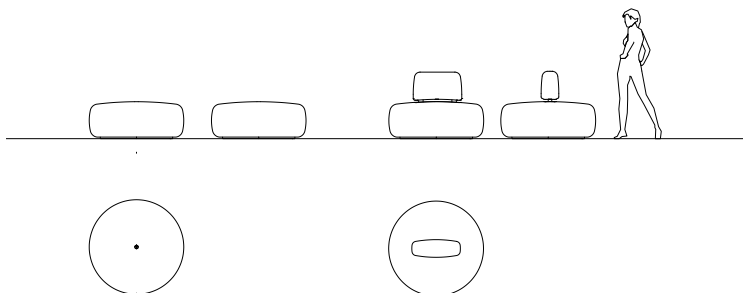

## NORMAN

Designer:	Massimo Tasca
Dimensions and weight Dimensiones y peso:	Ø 1200 mm H 845 mm h 470 mm with backrest   con respaldo 773 kg without backrest   sin respaldo 686 kg
Materials/Materiales:	HPC (High Performance Concrete)
Finishes/Acabados:	Velluto - Natural smooth Velluto - Liso natural
Fixing/Fijación:	Freestanding Apoyo
Accessories/Accesorios:	LED lighting Iluminación LED



## METALCO COMFORT PROGRAM

Consumption/Consumo:	0,18 kWh
Power/Potencia:	180 W
Info pag. 178	

DIAMANTE COLLECTION

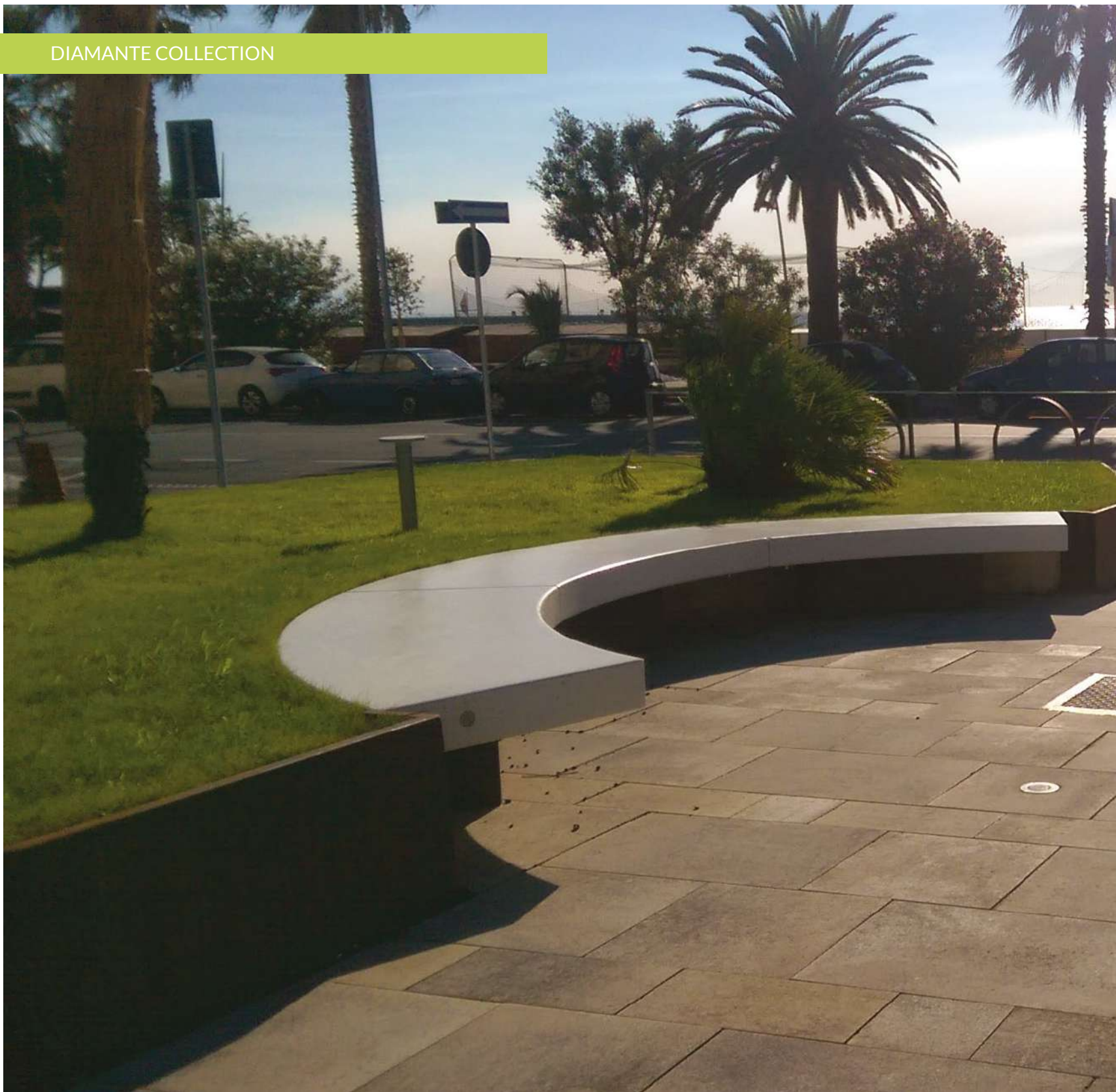









45°



15°



P

## DIAMANTE 45° | 15° | P

Designer:	<b>Alessandro Lenarda + Raffaele Lazzari + Michele Slaviero</b>
Dimensions and weight Dimensiones y peso:	<p><b>P</b> 2100x710 mm H 400 mm 435 kg</p> <p><b>45°</b> 2100x400 mm P 898 mm R 2000 mm 400 kg</p> <p><b>15°</b> 2150x 400 mm P 814 mm R 7500 mm 450 kg</p>
Materials/Materiales:	<p>HPC (High Performance Concrete) + Powder coated steel</p> <p>HPC (High Performance Concrete) + Acero pintado</p>
Finishes/Acabados:	<p>HPC Velluto - Natural smooth</p> <p>HPC Velluto - Liso natural</p>
Fixing/Fijación:	<p>Pre-drilled for anchors</p> <p>Predisposición para tacos</p>

Collection of modular benches, without backrest, made of HPC (High Performance Concrete) composed of a seat and two supports in steel plate or sheet. Three versions are available: two curved, one linear. They can be installed in composition with the other elements of the collection.

Colección de bancos modulares, sin respaldo realizados en HPC (High Performance Concrete), compuestos por una superficie que sirve de asiento y por dos soportes planos en acero o en chapa de acero. Disponibles tres versiones: dos curvas, una lineal. Pueden instalarse individualmente o en composición, combinándolos con otros elementos de la colección.

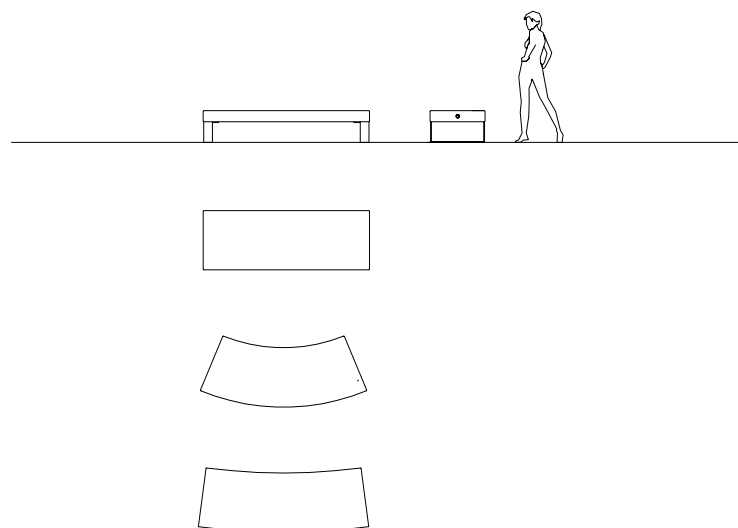



Cubic planters made of HPC (High Performance Concrete), equipped with a recess at the base. They can be installed in composition with the other elements of the collection.

Jardinera de forma cubica realizada en HPC (High Performance Concrete) dotada de un rebajo en la base. Puede instalarse en composición, combinándola con otros elementos de la colección.

## DIAMANTE F

Designer:	Metalco Design
Dimensions and weight Dimensiones y peso:	750x750 mm H 600 mm 420 kg
Materials/Materiales:	HPC (High Performance Concrete)
Finishes/Acabados:	Velluto - Natural smooth Velluto - Liso natural
Fixing/Fijación:	Freestanding Apoyo

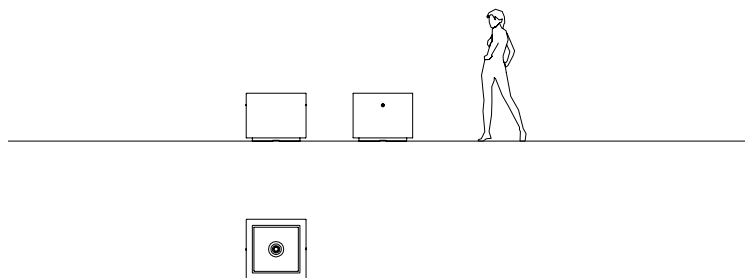



DIAMANTE



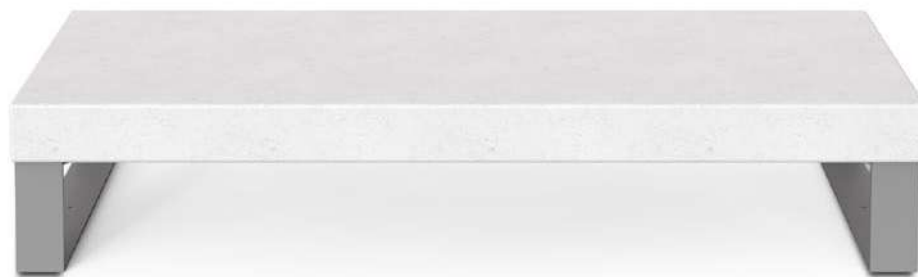

## METALCO COMFORT PROGRAM



### DIAMANTE 45°

Consumption/Consumo: 0,228 kWh

Power/Potencia: 228 W



### DIAMANTE 15°

Consumption/Consumo: 0,25 kWh

Power/Potencia: 250 W



### DIAMANTE P

Consumption/Consumo: 0,26 kWh

Power/Potencia: 260 W

Info pag. 178



DIAMANTE ACCESSORIES I







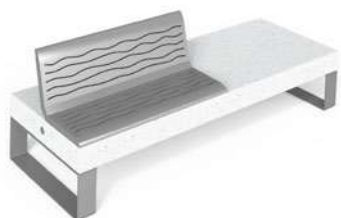

SS

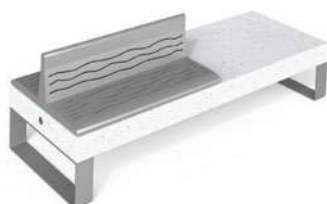

2SS



ST

## DIAMANTE ACCESSORIES I | SS | 2 SS | ST

Designer: **Alessandro Lenarda + Michele Slaviero + Raffaele Lazzari**

Dimensions and weight / Dimensiones y peso: **SS**  
1044x474 mm H 375 mm **23 kg**

**2SS**  
1044x730 mm H 326 mm **29 kg**

**ST**  
1456x195 mm H 266 mm **24 kg**

Materials/Materiales: **Powder coated steel o Stainless steel  
Acero pintado o Acero Inox**

Fixing/Fijación: **Pre-drilled for anchors  
Predisposición para tacos**

### DIAMANTE ACCESSORIES I: SS | 2SS | ST | SP | 2SP

The P model of the Diamante collection can be equipped with the following accessories:

The SS module: one or two seats with backrest made of a sheet of steel shaped and laser decorated.

The 2SS module: one or two double-sided seats with backrest made of a sheet of steel shaped and laser decorated.

The ST module: a backrest in steel tube.

The P model of the Diamante collection can be equipped with the following accessories:

The SP module: one or two seats, without backrest, made of a shaped steel sheet and laser decorated.

The 2SP module: one or two double-sided seats, without backrest made of a steel sheet with laser cut shaping and decorations.

### DIAMANTE ACCESSORIES I: SS | 2SS | ST | SP | 2SP

A los bancos modelo P de la colección Diamante pueden aplicarse los siguientes accesorios:

Módulo SS: uno o dos asientos con respaldo, realizado en chapa de acero perfilada y decorada con láser.

Módulo 2SS: uno o dos asientos bilaterales con respaldo, realizado en chapa de acero perfilada y decorada con láser.

Módulo ST: un respaldo en tubo de acero.

A los bancos modelo P de la colección Diamante pueden aplicarse los siguientes accesorios:

Módulo SP: uno o dos asientos sin respaldo, realizado en chapa de acero perfilada y decorada con láser.

Módulo 2SP: uno o dos asientos bilaterales sin respaldo, realizado en chapa de acero perfilada y decorada con láser.





SP



2SP

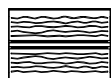
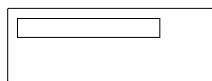
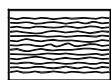
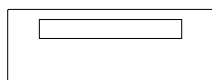
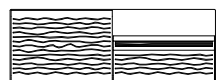
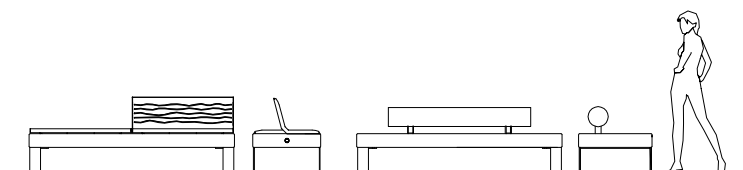

## DIAMANTE ACCESSORIES | SP | 2SP

Designer: **Alessandro Lenarda + Raffaele Lazzari + Michele Slaviero**

Dimensions and weight / Dimensiones y peso: **SP**  
1044x316 mm H 500 mm **9 kg**

**2SP**  
1044x316 mm H 500 mm **19 kg**

Materials/Materiales: **Powder coated steel o Stainless steel / Acero pintado o Acero Inox**

Fixing/Fijación: **Pre-drilled for anchors / Predisposición para tacos**

DIAMANTE ACCESSORIES W

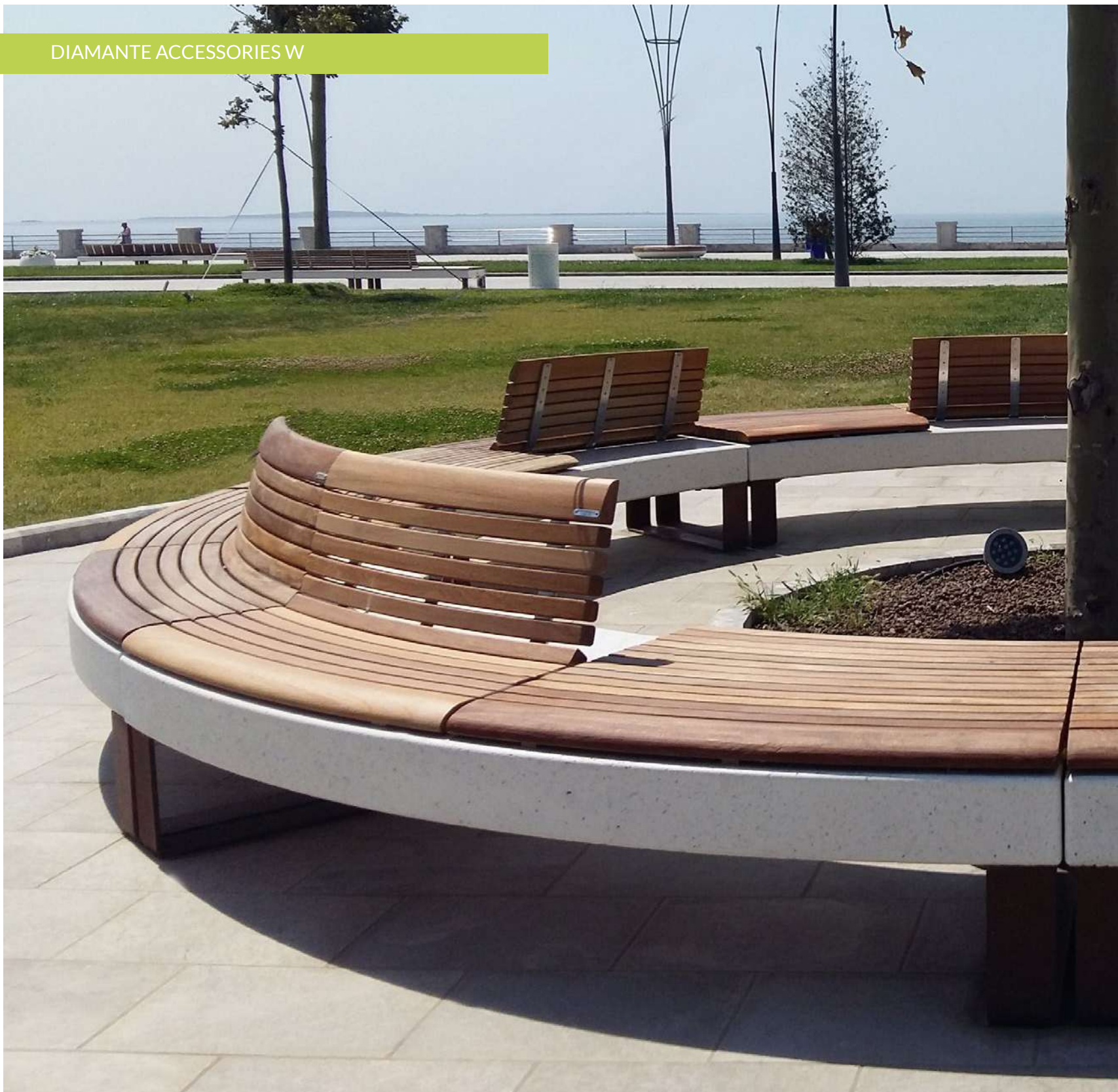







W SP



W 2SP



W SS



W 2SS

## DIAMANTE ACCESSORIES W SP | 2SP | SS | 2SS

Designer: **Alessandro Lenarda + Raffaele Lazzari + Michele Slaviero**

Dimensions and weight Dimensiones y peso:	SP	1044x316 mm H 50 mm	11 kg
	2SP	1044x730 mm H 50 mm	23 kg
	SS	1044x474 mm H 375 mm	25 kg
	2SS	1044x730 mm H 326 mm	36 kg

Materials/Materiales: **Powder coated steel + Hardwood  
Acero pintado + Madera dura**

Fixing/Fijación: **Pre-drilled for anchors  
Predisposición para tacos**

### DIAMANTE ACCESSORIES W SP | 2SP | SS | 2SS

The P model of the Diamante collection can be equipped with the following accessories:

The W SP module: a wooden seat without backrest.

The W 2SP module: a double-sided wooden seat without backrest.

The W SS module: a wooden seat with backrest.

The W2SS module: a double-sided wooden seat with backrest.

### DIAMANTE ACCESSORIES W 2S 45° | SSI 45° | SSE 45°

The 45° bench of the Diamante collection can be equipped with the following accessories:

The 2S 45° module: a double-sided wooden seat without backrest.

The SSI 45° module: single wooden seat with backrest positioned on the concave side of the bench.

The SSE 45° module: single wooden seat with backrest positioned in the convex side of the bench.

### DIAMANTE ACCESSORIES W SP | 2SP | SS | 2SS

Los bancos modelo P de la colección Diamante pueden alojar uno o dos de los siguientes accesorios:

Módulo W SP, asiento sin respaldo, en madera.

Módulo W 2SP, asiento bilateral sin respaldo, en madera.

Módulo W SS, asiento con respaldo, en madera.

Módulo W 2SS, asiento bilateral con respaldo, en madera.

### DIAMANTE ACCESSORIES W 2S 45° | SSI 45° | SSE 45°

Los bancos modelo 45° de la colección Diamante pueden alojar uno o dos de los siguientes accesorios:

Módulo 2S 45°, asiento bilateral sin respaldo, en madera.

Módulo SSI 45°, asiento monoplaza con respaldo, en madera ubicado en el lado cóncavo del banco.

Módulo SSE 45°, asiento monoplaza con respaldo, en madera, ubicada en el lado convexo del banco.





W 2S 45°



W SSI 45°



W SSE 45°

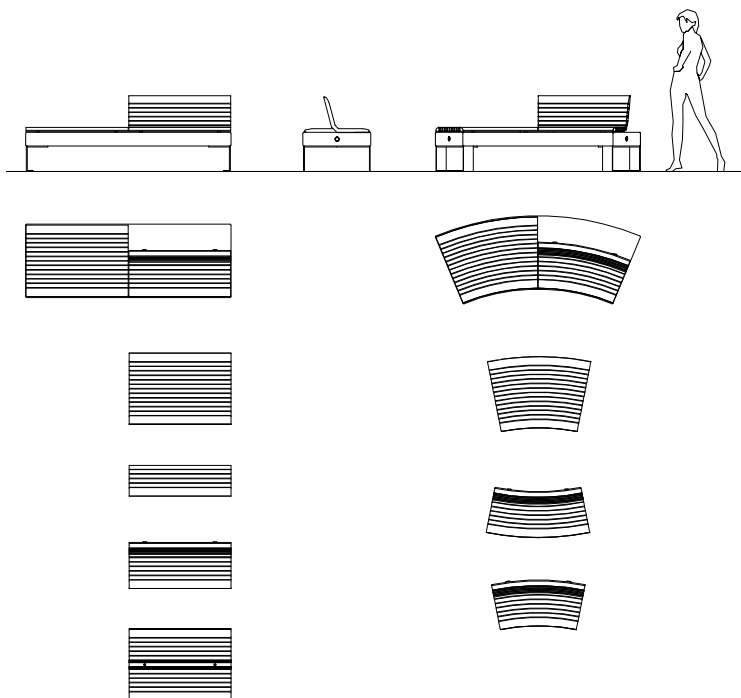

### DIAMANTE ACCESSORIES W 2S 45° | SSI 45° | SSE 45°

Designer: **Alessandro Lenarda + Raffaele Lazzari + Michele Slaviero**

Dimensions and weight  
Dimensiones y peso: **2S 45°**  
1060x730 mm H 50 mm Ri 2010 mm  
22 kg

**SSI 45°**  
960x470 mm H 375 mm Ri 2010 mm  
23 kg

**SSE 45°**  
1060x470 mm H 375 mm Ri 2740 mm  
25 kg

Materials/Materiales: **Powder coated steel + Hardwood**  
Acero pintado + Madera dura

Fixing/Fijación: **Pre-drilled for anchors**  
Predisposición para tacos

I - BOX COLLECTION

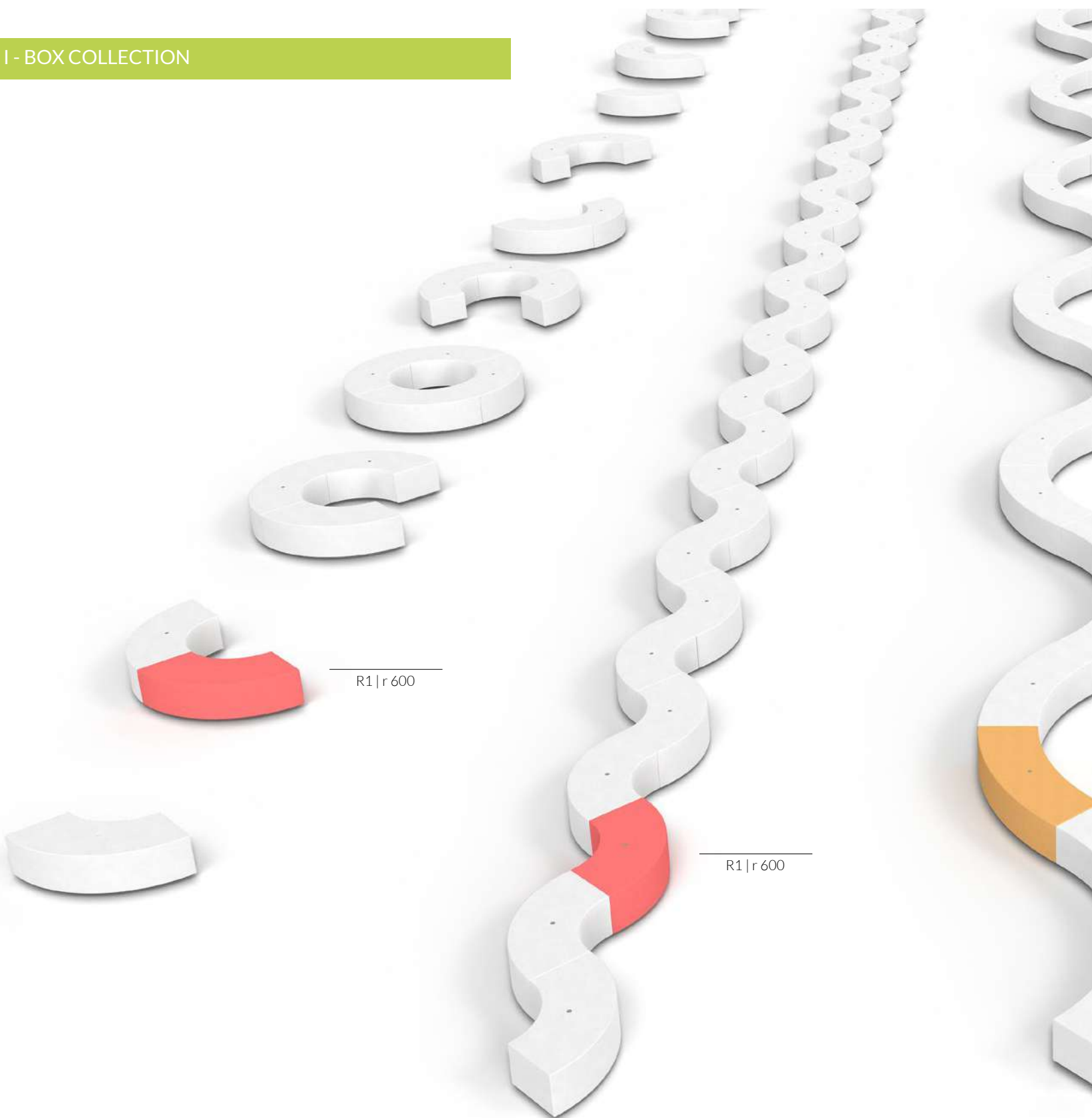

R1|r600

R1|r600



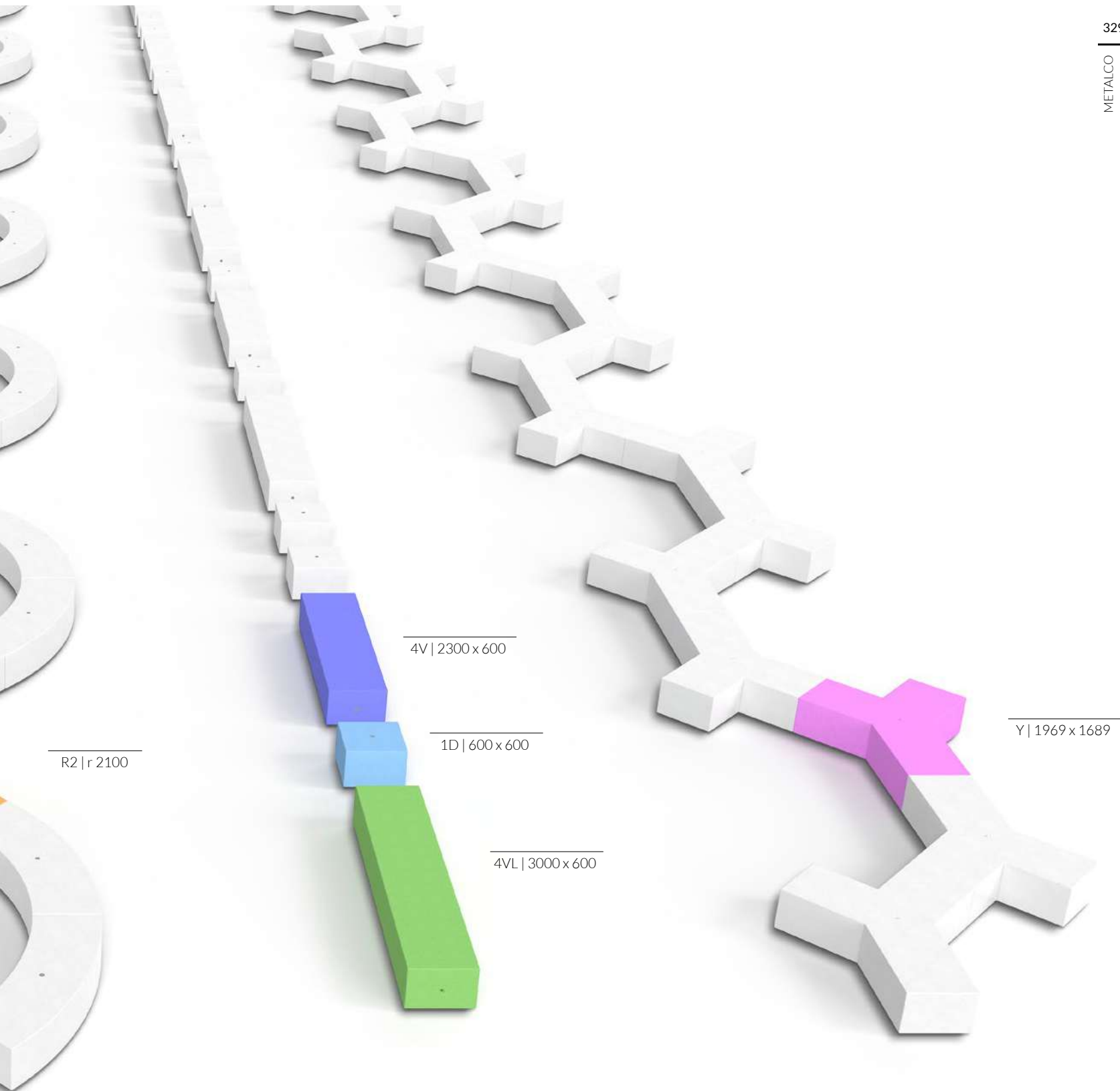

I - BOX COLLECTION









R1



R2



1D

## I - BOX COLLECTION

Designer:	Pio & Tito Toso + Massimo Tasca
Dimensions and weight Dimensiones y peso:	<p><b>R1</b> 1680x768 mm Ri 600 mm H 440 mm 590 kg</p> <p><b>R2</b> 2050x775 mm Ri 2100 mm H 440 mm 760 kg</p> <p><b>1D</b> 600x600 mm H 440 mm 310 kg</p>
Materials/Materiales:	HPC (High Performance Concrete)
Finishes/Acabados:	Velluto - Natural smooth Velluto - Liso natural
Fixing/Fijación:	Freestanding Apoyo
Accessories/Accesorios:	LED lighting Iluminación LED

Collection of modular monolithic seats, without backrest, made of HPC (High Performance Concrete), partially emptied inside, with recess at the base. The following modules are available:

1D: cubic single module.

R1 and R2: curved modules, that differ for the angle width.

4V and 4VL: linear modules, that differ for the length.

4Y: Y-shaped module.

The seats can be installed individually or in composition.

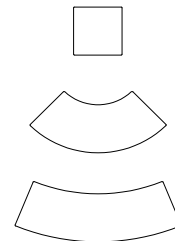
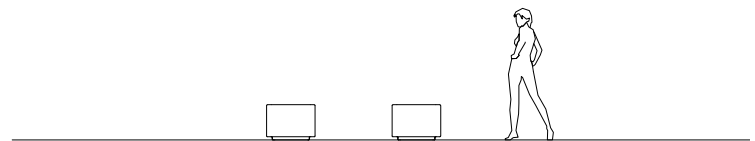



4V



4VL



Y

Colección de asientos modulares monolíticos sin respaldo, en HPC (High Performance Concrete) aligeradas internamente, con rebajo en la base. Disponibles los siguientes módulos:

1D: módulo monoplaza de forma cúbica.

R1 y R2: módulos curvos, diferentes por la medida del ángulo.

4V y 4VL: módulos lineales, diferentes por longitud.

4Y: módulo en forma de "Y".

Los asientos pueden ser instalados individualmente o en composición.

## I - BOX COLLECTION

Designer:	Pio & Tito Toso + Massimo Tasca	
Dimensions and weight Dimensiones y peso:	4V 2300x600 mm H 440 mm	970 kg
	4VL 3000x600 mm H 440 mm	1245 kg
	Y 1969x1689 mm H 440 mm	1050 kg
Materials/Materiales:	HPC (High Performance Concrete)	
Finishes/Acabados:	Velluto - Natural smooth Velluto - Liso natural	
Fixing/Fijación:	Freestanding Apoyo	
Accessories/Accesorios:	LED lighting Iluminación LED	

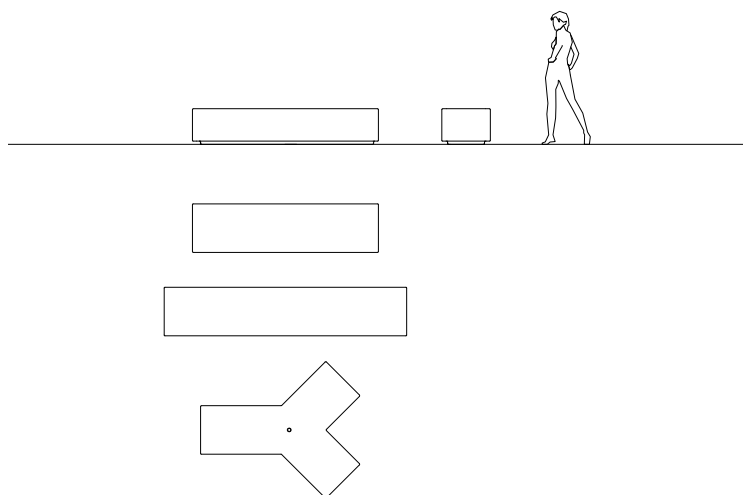

I - BOX COLLECTION







## METALCO COMFORT PROGRAM



### I - BOX 1D

Consumption/Consumo: 0,05 kWh

Power/Potencia: 50 W



### I - BOX 4V

Consumption/Consumo: 0,22 kWh

Power/Potencia: 220 W



### I - BOX 4VL

Consumption/Consumo: 0,29 kWh

Power/Potencia: 290 W



### I - BOX R1

Consumption/Consumo: 0,13 kWh

Power/Potencia: 130 W



### I - BOXV R2

Consumption/Consumo: 0,18 kWh

Power/Potencia: 180 W



### I - BOX Y

Consumption/Consumo: 0,24 kWh

Power/Potencia: 240 W

I - BOX B

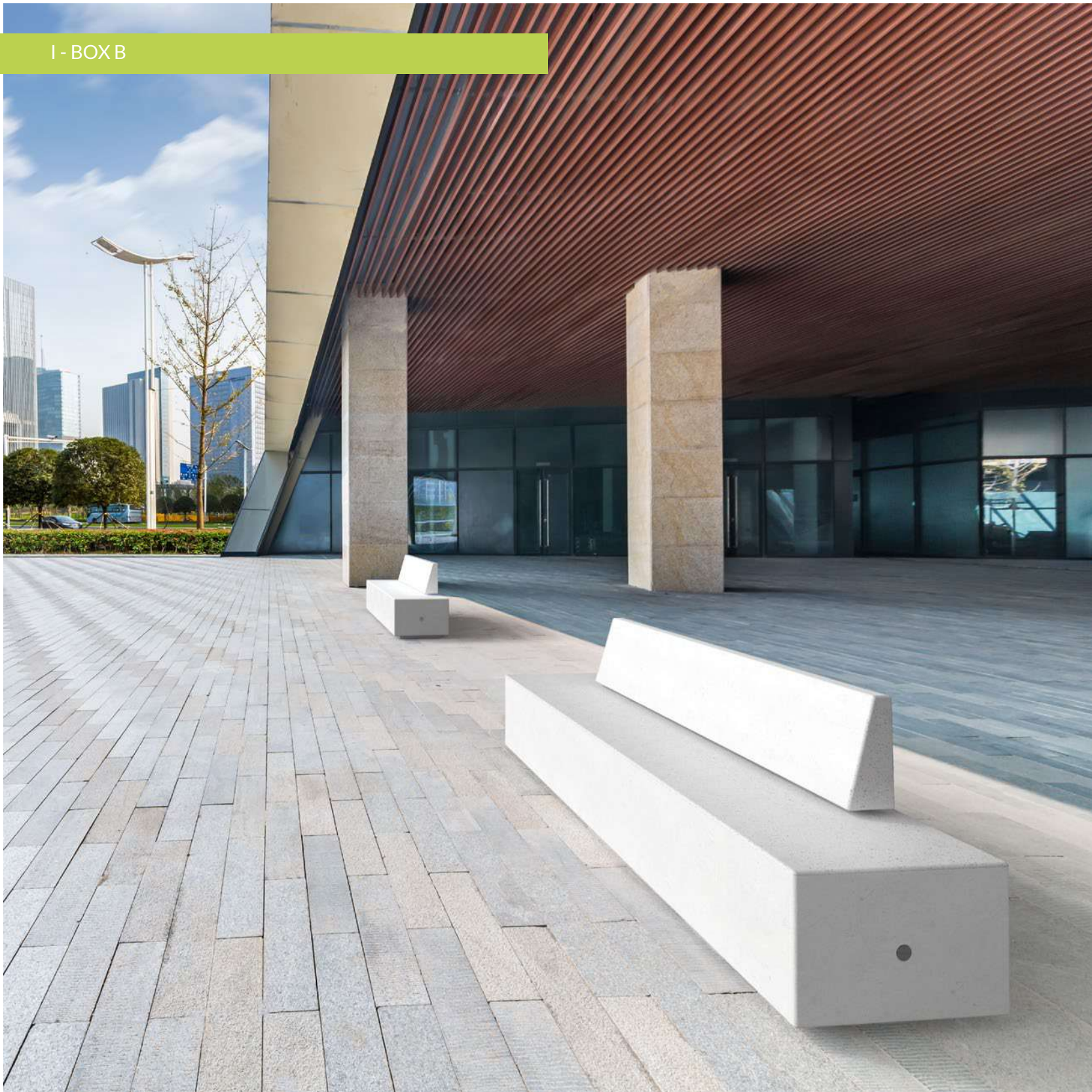



Collection of modular monolithic seats with backrest made of HPC (High Performance Concrete), partially emptied inside, with recess at the base. Two lengths are available.

Colección de asientos modulares monolíticos con respaldo, en HPC (High Performance Concrete), aligerados internamente, con rebajo en la base. Disponible en dos largos.

## I - BOX B

Designer:	Pio & Tito Toso + Massimo Tasca	
Dimensions and weight: Dimensiones y peso:	2300x600 mm H 790 mm h 440 mm 1122 kg	3000x600 mm H 790 mm h 440 mm 1397 kg
Materials/Materiales:	HPC (High Performance Concrete)	
Finishes/Acabados:	Velluto - Natural smooth Velluto - Liso natural	
Fixing/Fijación:	Freestanding Apoyo	
Accessories/Accesorios:	LED lighting Iluminación LED	

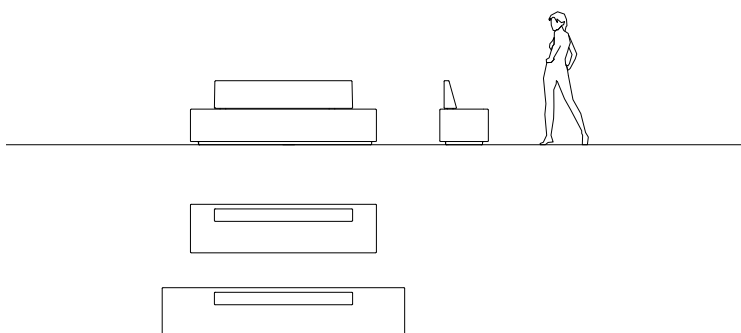

## METALCO COMFORT PROGRAM

Consumption/Consumo:	0,22 kWh	0,29 kWh
Power/Potencia:	220 W	290 W



I - BOX ACCESSORIES









R1 + 2 SB + A



R2 + 3 SB + 2 A



4V + 2 A

## I - BOX ACCESSORIES

Designer: **Pio & Tito Toso + Massimo Tasca**

Dimensions and weight  
Dimensiones y peso:

<b>SB - R1</b> 557 mm H 316 mm	<b>10 kg</b>
-----------------------------------	--------------

<b>SB - R2</b> 555 mm H 316 mm	<b>11 kg</b>
-----------------------------------	--------------

<b>A</b> 308x60 mm H 130 mm	<b>2 kg</b>
--------------------------------	-------------

Materials/Materiales: **Powder coated steel  
Acero pintado**

Fixing/Fijación: **Pre-drilled for anchors  
Predisposición para tacos**

The R1, R2, 4V benches of the I-Box collection can accommodate from one to two armrests (A) in steel sheet.

Los bancos modelos R1, R2, 4V de la colección I-Box pueden completarse con uno o dos apoyabrazos (A) en acero barnizado.

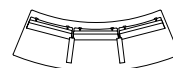
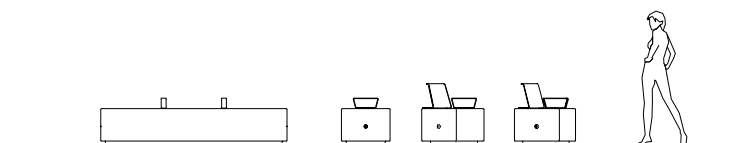





1D + SB



4V + 3 SB + 2 A

The 1D, R1, R2, 4V benches of the I-Box collection can accommodate from one to three backrests in sheet steel (SB), depending on the model.

Los bancos modelo D1, R1, R2, 4V de la colección I-Box pueden completarse con respaldos (de 1 a tres según el modelo) en chapa de acero (SB).

## I - BOX ACCESSORIES

Designer:	Pio & Tito Toso + Massimo Tasca	
Dimensions and weight Dimensiones y peso:	SB - 1D 490 mm H 316 mm	10 kg
	SB - 4V 740 mm H 316 mm	15 kg
Materials/Materiales:	Powder coated steel Acero pintado	
Fixing/Fijación:	Pre-drilled for anchors Predisposición para tacos	

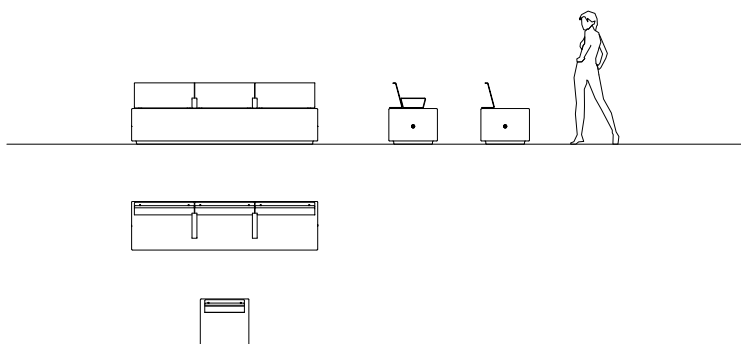

STONE









STONE





Collection of free-form seats in three sizes (S - M - L), made of HPC (High Performance Concrete), partially emptied inside. The L version is also available in UHPC (Ultra High Performance Concrete), further lightened.

Colección de asientos de forma libre en tres tamaños (S - M - L), realizados en HPC (High Performance Concrete), aligerados internamente. La versión L está disponible, también en UHPC (Ultra High Performance Concrete), haciéndola aún más ligera.

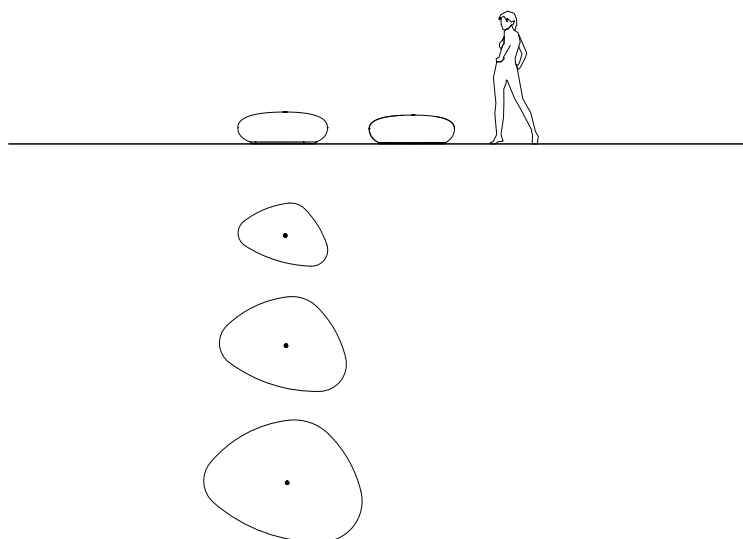

## STONE

Designer:	Raffaele Lazzari
Dimensions and weight Dimensiones y peso:	<p><b>STONE S</b> 1100x780 mm H 395 mm 338 kg</p> <p><b>STONE M</b> 1570x1185 mm H 470 mm 755 kg</p> <p><b>STONE L</b> 1960x1520 mm H 510 mm HPC 1185 kg UHPC 430 kg</p>
Materials/Materiales:	<p>HPC (High Performance Concrete) or UHPC (Ultra High Performance Concrete) only Stone L</p> <p>HPC (High Performance Concrete) o UHPC (Ultra High Performance Concrete) solo Stone L</p>
Finishes/Acabados:	<p>HPC Velluto - Natural smooth HPC Velluto - Liso natural</p> <p>UHPC Alfa - Natural smooth UHPC Alfa - Liso natural</p>
Fixing/Fijación:	<p>Freestanding with pedestals or Installation with threaded bars Apoyo con pies o Cimentación con varillas roscadas</p>



STONE







## METALCO COMFORT PROGRAM

### STONE S

Consumption/Consumo: 0,09 kWh

Power/Potencia: 90 W

### STONE M

Consumption/Consumo: 0,22 kWh

Power/Potencia: 220 W

### STONE L

Consumption/Consumo: 0,38 kWh

Power/Potencia: 380 W

MONOLIGHT











LMM 1



LMM 2

A limited edition artistic selection, produced by the Italian artist and designer Lorenzo Maria Monti. The free-form seats are made of HPC (High Performance Concrete) and decorated with four patterns. The colours of the decorations can be customized. During the coating process, the customer can choose one of them to be pigmented with a special substance that reacts to a source of UV rays\* and lights up the seats and the surrounding area. Three sizes partially emptied inside are available.

\*To see the artistic effect it is necessary to install on-site a lighting system equipped with UV lamps.

Serie de arte en una edición limitada, creada por el artista y diseñador italiano Lorenzo Maria Monti y compuesta por asientos de forma libre en HPC (High Performance Concrete), decorados con cuatro motivos. El color de las decoraciones se puede personalizar: uno de los cuales (a elección del cliente) se pigmenta durante la fase de pintado, con una sustancia particular que, reaccionando a una fuente de rayos UV\*, ilumina los asientos y el entorno circundante. Disponible en tres tamaños, interior aligerado.

\* Se debe instalar un sistema de iluminación equipado con lámparas UV para ver el efecto artístico.



LMM 3



LMM 4

## MONOLIGHT

Artist/Artista:	Lorenzo Maria Monti		
Dimensions and weight	1960x1520 mm H 510 mm		
Dimensiones y peso:	HPC	1185 kg	
	UHPC	430 kg	
Materials/Materiales:	HPC (High Performance Concrete) o UHPC (Ultra High Performance Concrete)		
Finishes/Acabados:	Painting - Pintura		
Fixing/Fijación:	Freestanding with pedestals or Installation with threaded bars Apoyo con pies o Cimentación con varillas roscadas		

MONOLIGHT





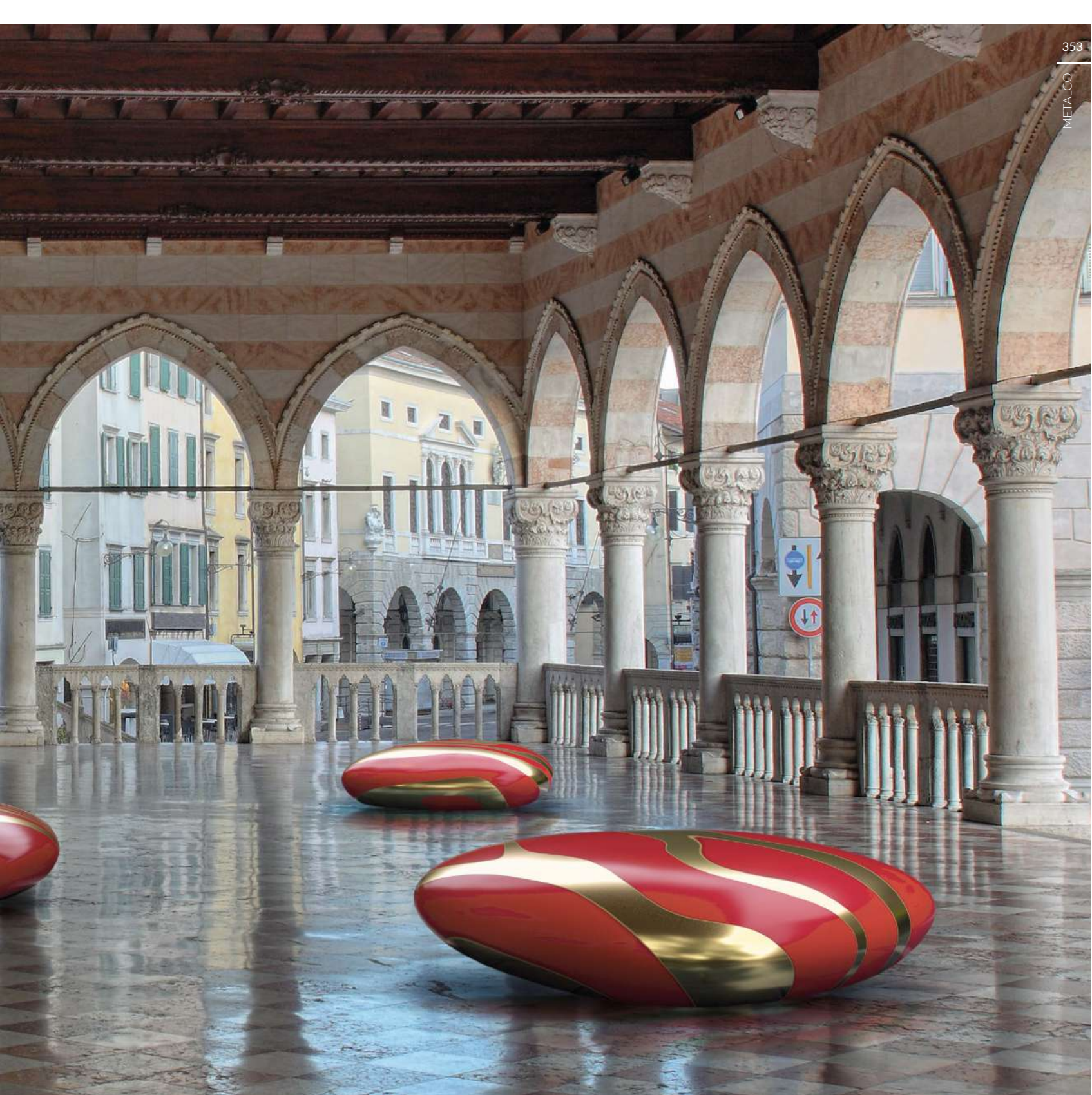



## MOONSTONE W

Designer:	Pamio Design
Dimensions and weight Dimensiones y peso:	2500x2600 mm H 740 mm (+210 mm) 4260 kg
Materials/Materiales:	PDM (Reconstituted Stones) + Okumè wood PDM (Piedras Reconstituidas) + Madera de Okumè
Finishes/Acabados:	PDM Sandblasted or Polished PDM Tratado con chorro de arena o Pulido
Fixing/Fijación:	Below ground installation Cimentación
Accessories/Accesorios:	Lifting bends Kit de cuerdas de elevación  Colour painting Pintura de color

Free-form monolithic seat, made of PDM (Reconstituted Stones) equipped with Okumè wooden bench and prepared for fixing to the ground on a concreted leveling base.

Asiento monolítico de forma libre, realizada en PDM (Piedras Reconstituidas) dotado de un banco de madera Okumè y predispuesto para la fijación al suelo mediante la cementación de una base nivelante.

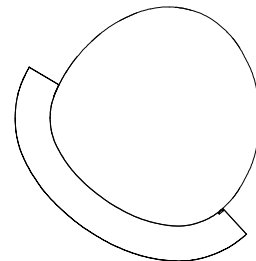
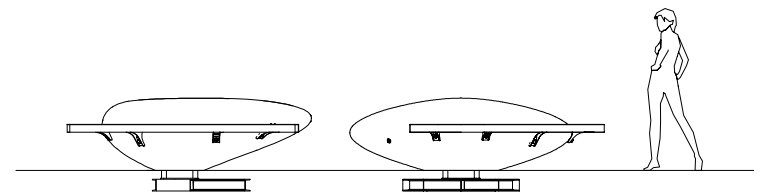





Free-form monolithic seat, made of PDM (Reconstituted Stones) and prepared for fixing to the ground on a concreted leveling base.

Asiento monolítico de forma libre, realizado en PDM (Piedras Reconstituidas), predispuesto para la fijación al suelo mediante la cementación de una base nivelante.

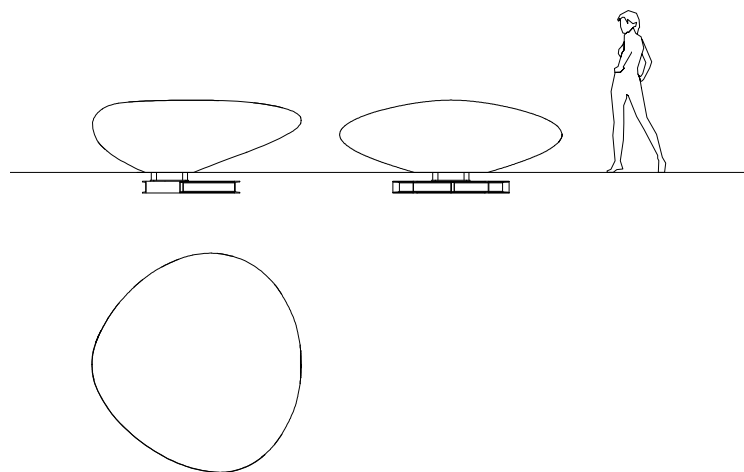

## MOONSTONE

Designer:	Pamio Design
Dimensions and weight Dimensiones y peso:	2140x2275 mm H 740 mm (+210 mm) 4200 kg
Materials/Materiales:	PDM (Reconstituted Stones) PDM (Piedras Reconstituidas)
Finishes/Acabados:	Sandblasted or Polished Tratado con chorro de arena o Pulido
Fixing/Fijación:	Below ground installation Cimentación
Accessories/Accesorios:	Lifting bends Kit de cuerdas de elevación  Colour painting Pintura de color



LIVE









LIVE







Chaise longue in WPC (Wood Polymer Composite) with laser-shaped steel sheet side supports and steel tube reinforcements.

Chaise longue con listones de WPC (Wood Polymer Composites) con los laterales en chapa de acero cortados a láser y refuerzos en tubo de acero.

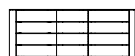
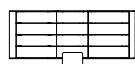
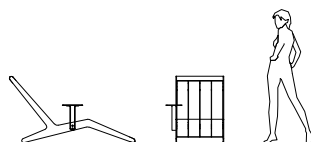

## LIVE

Designer:	Pio & Tito Toso
Dimensions and weight Dimensiones y peso:	1555x590 mm H 820 mm 50 kg
Materials/Materiales:	Powder coated steel + WPC Ultra (Wood Polymer Composite) Acero pintado + WPC Ultra (Wood Polymer Composite)
Fixing/Fijación:	Installation with threaded bars Cimentación con varillas roscadas
Accessories/Accesorios:	Right table in steel Mesita derecha en acero

LIBRE







LP 200



L 200



TUBO P

TUBO I

ARCO

Collection of benches, with or without backrest, equipped with two or three arc supports in cast aluminum or vertical supports in steel tube. The seat and the backrest are made of steel tubes welded on proper support linked together by a steel tube bar.

Colección de bancos con o sin respaldo, dotados de dos o tres soportes arqueados en fundición de aluminio o verticales en tubo de acero. La superficie de asiento y el respaldo están formados por una serie de tubitos en acero, soldados a los soportes a través de una barra horizontal en tubo de acero.

## LIBRE

Designer:	Alfredo Tasca
Dimensions and weight Dimensiones y peso:	<p>LP 200 2000x584 mm H 451 mm (+ 300 mm) 38 kg</p> <p>L 200 2000x584 mm H 814 mm 52 kg</p>
Materials/Materiales:	<p>Powder coated steel or Stainless steel + Powder coated aluminum or Powder coated steel Acero pintado o Acero Inox + Aluminio pintado o Acero pintado</p>
Fixing/Fijación:	<p>Freestanding with pedestals or Installation with threaded bars Apoyo con pies o Cimentación con varillas roscadas</p>
Accessories/Accesorios:	<p>Ground fixing kit Kit de fijación au sol</p> <p>Aluminum armrests Apoyabrazos de aluminio</p>

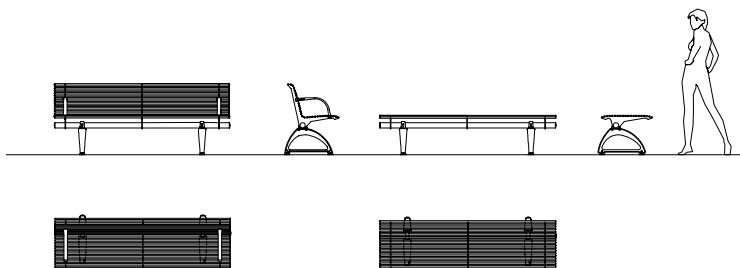



LIBRE SETTORE

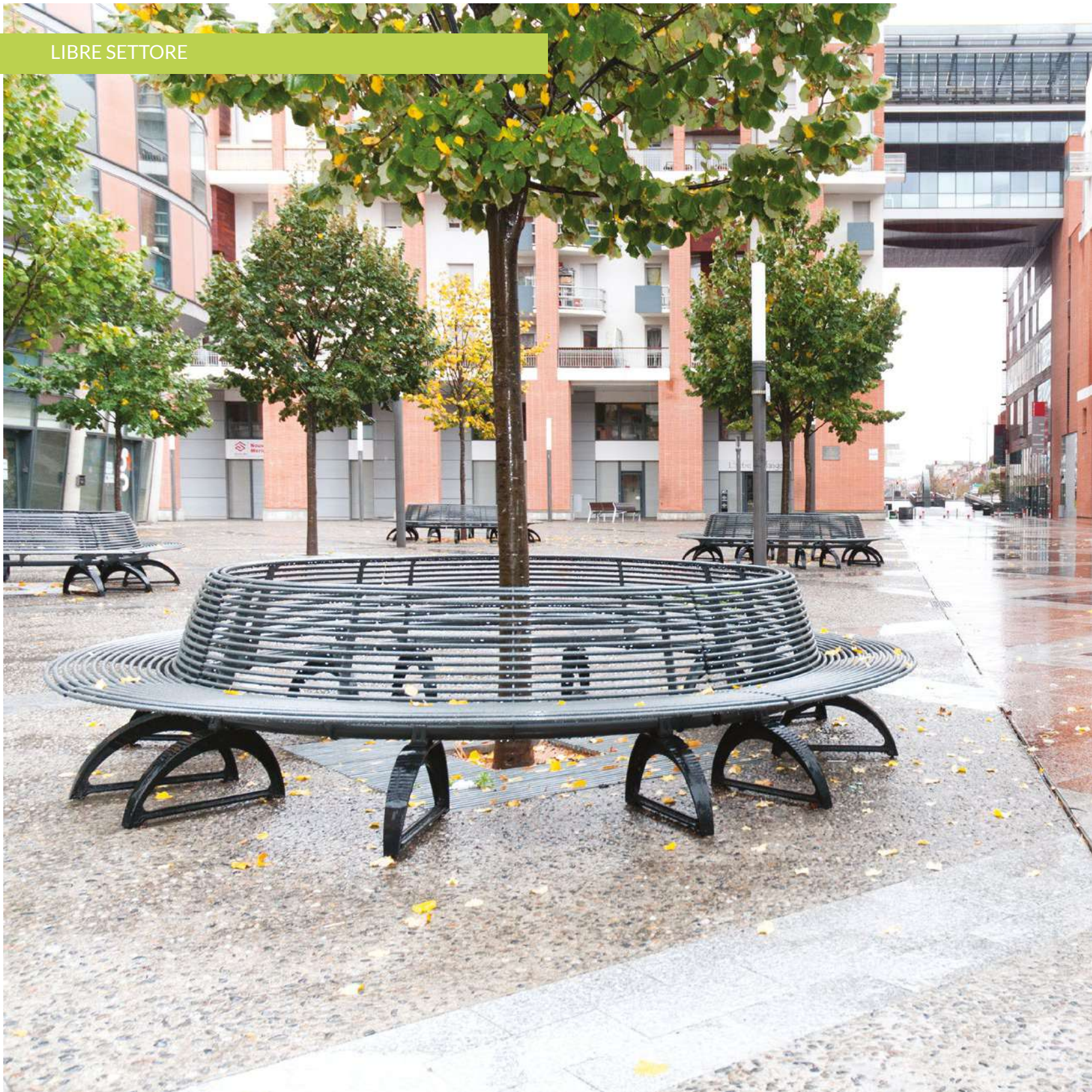



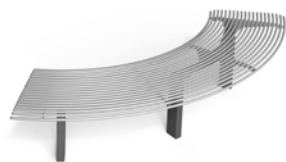

LP SE

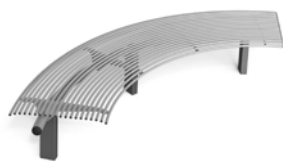

LP SI



L SE



L SI



TUBO P TUBO I

ARCO

Collection of curved modular benches, with or without backrest, equipped with three arc supports in cast aluminum or vertical supports in steel tube. The seat and the backrest are made of steel tubes welded to proper supports linked together by a steel tube bar. Two versions, concave and convex, are available. Each model can be installed individually or in composition with the other elements of the Libre Settore collection.

Colección de bancos modulares curvos, con o sin respaldo, dotados de tres soportes arqueados en fundición de aluminio o verticales en tubo de acero. La superficie de asiento y el respaldo están formados por una serie de tubitos en acero, soldados a los soportes a través de una barra en tubo de acero. Disponible en dos versiones, una cóncava, otra convexa. Cada modelo puede ser instalado individualmente o en composición, combinándolo con los otros elementos de la colección Libre Settore.

## LIBRE SETTORE

Designer:	Alfredo Tasca
Dimensions and weight Dimensiones y peso:	1700x1700 mm Ri 1110 mm Re 1700 mm H 814 mm h 451 mm (+ 300 mm)
	LP SE 45 kg LP SI 45 kg L SE 60 kg L SI 65 kg
Materials/Materiales:	Powder coated steel or Stainless steel + Powder coated aluminum or Powder coated steel Acero pintado o Acero Inox + Aluminio pintado o Acero pintado
Fixing/Fijación:	Freestanding with pedestals or Below grown installation or Pre-drilled for anchors Apoyo con pied o Cimentación o Predisposición para tacos
Accessories/Accesorios:	Ground fixing kit Kit de fijación au sol  Aluminum armrests Apoyabrazos de aluminio

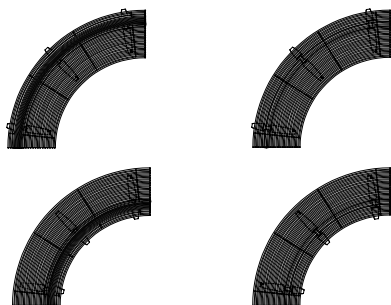

LIBRE EVOLUTION











TDX 2700

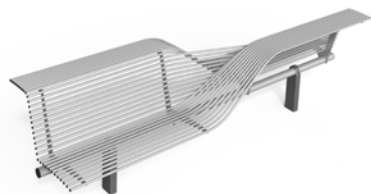

TSX 2700



HDX 2700



HSX 2700

## LIBRE EVOLUTION TORSION - HALF

Designer:	Alfredo Tasca
Dimensions and weight Dimensiones y peso:	2700x760 mm H 810 mm h 458 mm TDX 2700   TSX 2700 90 kg HDX 2700   HSX 2700 75 kg
Materials/Materiales:	Powder coated steel or Stainless steel + Powder coated aluminum or Powder coated steel Acero pintado o Acero Inox + Aluminio pintado o Acero pintado
Fixing/Fijación:	Freestanding with pedestals or Below grown installation or Pre-drilled for anchors Apoyo con pied o Cimentación o Predisposición para tacos
Accessories/Accesorios:	Ground fixing kit Kit de fijación au sol  Aluminum armrests Apoyabrazos de aluminio

Collection of modular benches with double-sided seats, with or without backrest, equipped with two arc or vertical supports, made of cast aluminium or steel tube. The seat and the backrest are made of steel tubes welded to proper support linked together by a horizontal bar in steel tube. The backrest has a particular shape that makes it usable, on the outside, as a leaning seat.

The following models are available: linear with or without backrest (LE 2000, LEP 2000), with half right or left backrest (HDX2700, HSX 2700), Torsion version, equipped with two seats with backrests on opposite sides (TDX 2700, TSX 2700). Each model can be installed individually or in composition with the other elements of the Libre Evolution collection.

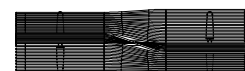
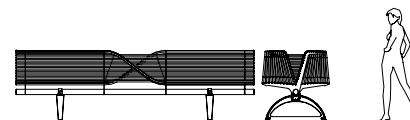





LE 2000



LEP 2000



TUBO P

TUBO I

ARCO

Colección de bancos modulares con asientos bilaterales, con o sin respaldo, dotados de dos soportes arqueados o verticales, realizados en fundición de aluminio o en tubo de acero. La superficie del asiento o el respaldo están formados por una serie de tubitos en acero soldados a los soportes a través de una barra horizontal en tubo de acero. El respaldo tiene una forma peculiar que hace posible que la parte externa se pueda utilizar como asiento isquiático.

Disponibles los siguientes modelos: lineal con o sin respaldo (LE 2000, LEP 2000), con medio respaldo derecho o izquierdo (HD X2700, HXS 2700), y en versión Torsion, dotada de dos asientos con respaldos contrapuestos (TDX 2700, TSX 2700). Cada modelo puede ser instalado individualmente o en composición, combinándolo con otros elementos de la colección Libre Evolution.

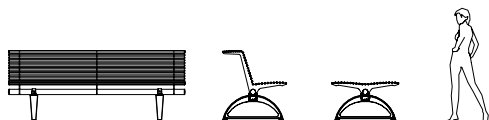

## LIBRE EVOLUTION

Designer:	Alfredo Tasca
Dimensions and weight Dimensiones y peso:	<p>LE 2000 2000x730 mm H 810 h 458 mm 60 kg</p> <p>LEP 2000 2000x760 mm H 458 mm 50 kg</p>
Materials/Materiales:	Powder coated steel or Stainless steel + Powder coated Aluminum Acero pintado o Acero Inox + Aluminio pintado
Fixing/Fijación:	Freestanding with pedestals or Below grown installation or Pre-drilled for anchors Apoyo con pied o Cimentación o Predisposición para tacos
Accessories/Accesorios:	Ground fixing kit Kit de fijación au sol  Aluminum armrests Apoyabrazos de aluminio

LIBRE DOPPIA

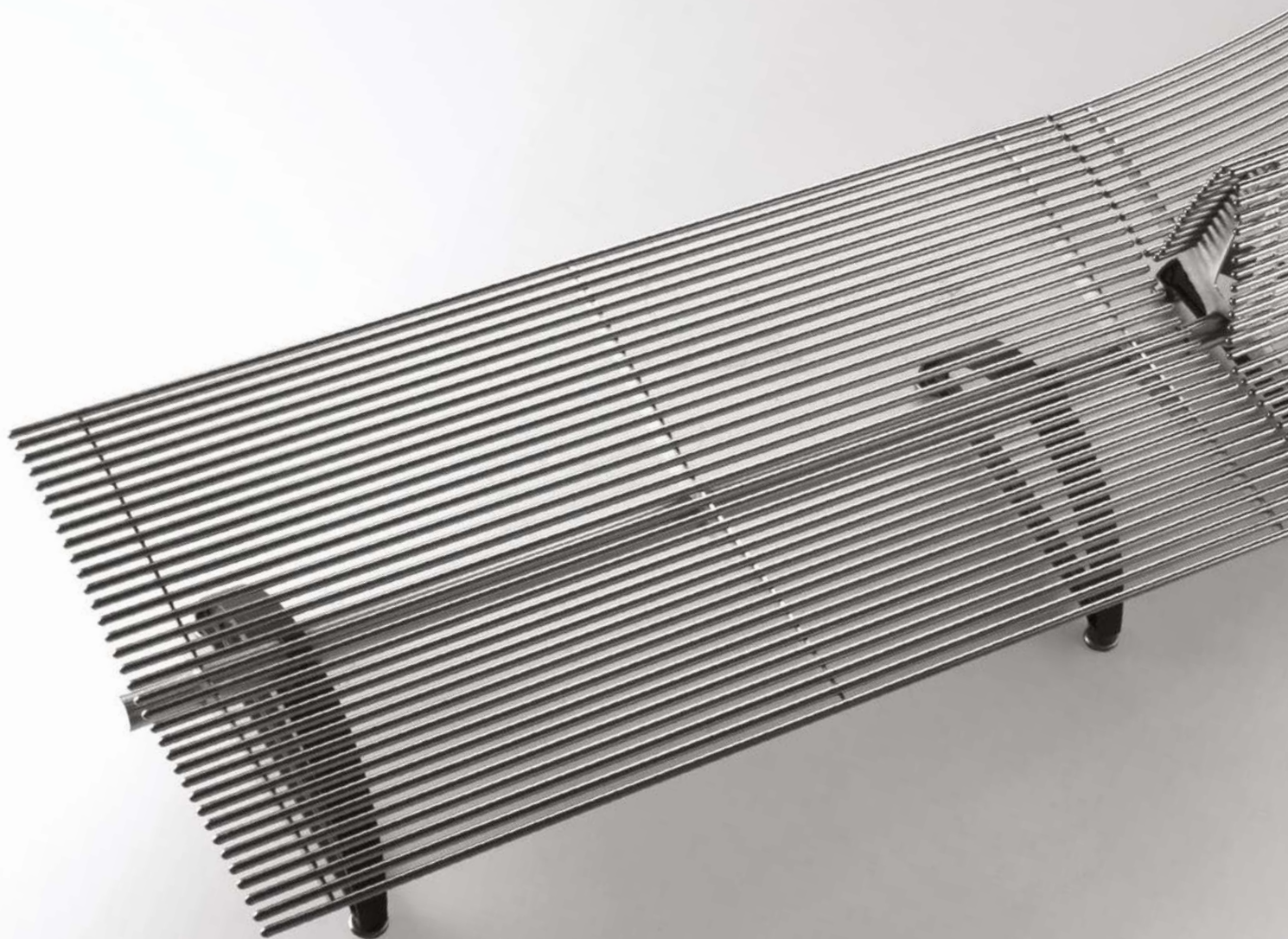





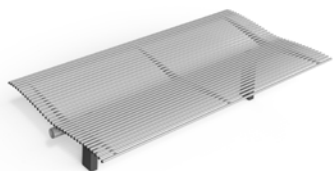

DP



D

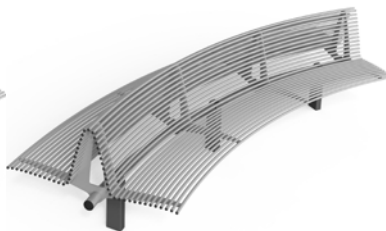

DS 45

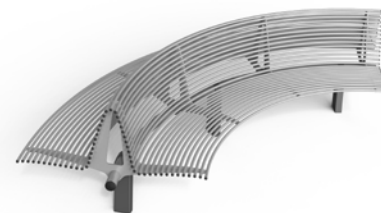

DS 90

## LIBRE DOPPIA

Designer: **Alfredo Tasca**

Dimensions and weight  
Dimensiones y peso:

DP   D	2000x1045 mm H 810 mm h 458 mm
DP	65 kg
D	90 kg

DS 45   DS 90	3040x1368 mm Ri 1100 mm Re 2145 mm
	H 810 mm h 458 mm
DS 45	120 kg
DS 90	113 kg

Materials/Materiales: Powder coated steel or Stainless steel + Powder coated Aluminum  
Acero pintado o Acero Inox + Aluminio pintado

Fixing/Fijación: Freestanding with pedestals or Below grown installation or Pre-drilled for anchors  
Apoyo con pied o Cimentación o Predisposición para tacos

Accessories/Accesorios: Ground fixing kit  
Kit de fijación au sol

Aluminum armrests  
Apoyabrazos de aluminio

Collection of modular benches with double-sided seats, with or without backrest, equipped with two or three arc supports in cast aluminium or vertical supports in steel tube. The seat and the backrest are made of steel tubes welded to proper supports linked together by a horizontal bar in steel tube. Six models, with or without backrest, are available: four curved, two linear. Each model can be installed individually or in composition with the other elements of the Libre Doppia collection.

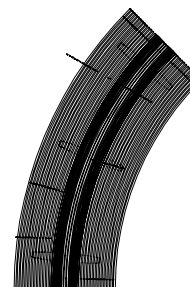
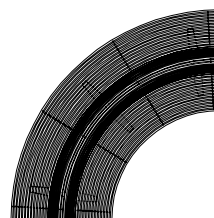
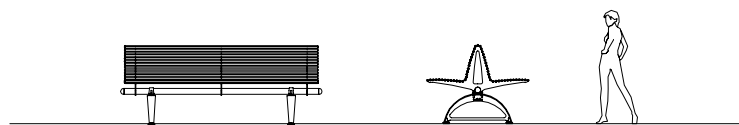



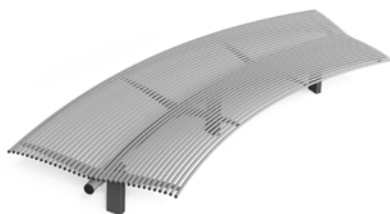

DPS 45

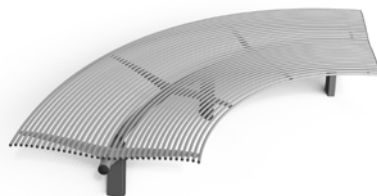

DPS 90



TUBO P

TUBO I

ARCO

Colección de bancos modulares con asientos bilaterales, con o sin respaldo, dotados de dos o tres soportes arqueados en fundición de aluminio o verticales en tubo de acero. La superficie de asiento y el respaldo están formados por una serie de tubitos en acero soldados a los soportes conectados a través de una barra horizontal en tubo de acero. Disponibles seis modelos con o sin respaldo: cuatro curvos, dos lineales. Cada modelo puede ser instalado individualmente o en composición, combinándolo con otros elementos de la colección Libre Doppia.

## LIBRE DOPPIA

Designer:

Alfredo Tasca

Dimensions and weight  
Dimensiones y peso:

3091x1273 mm Ri 3000 mm Re 4035 mm  
H 810 mm h 458 mm

DPS 45	90 kg
DPS 90	80 kg

Materials/Materiales:

Powder coated steel or Stainless steel +  
Powder coated aluminum or Powder coated  
steel  
Acero pintado o Acero Inox + Aluminio  
pintado o Acero pintado

Fixing/Fijación:

Freestanding with pedestals or Below grown  
installation or Pre-drilled for anchors  
Apoyo con pied o Cimentación o  
Predisposición para tacos

Accessories/Accesorios:

Ground fixing kit  
Kit de fijación au sol

Aluminum armrests  
Apoyabrazos de aluminio

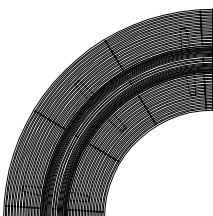
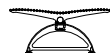





















## LIBRE 2.0

Designer:	Alfredo Tasca
Dimensions and weight Dimensiones y peso:	1750x610 mm H 795 mm h 432 mm 55 kg
	3000x610 mm H 795 mm h 432 mm 87 kg
Materials/Materiales:	Powder coated steel Acero pintado
Fixing/Fijación:	Freestanding with pedestals or Installation with threaded bars Apoyo avec pieds de support o Cimentación avec tiges filetées

Collection of benches with backrest and armrests, made of steel rod, equipped with steel sheet reinforcements and two or three supports. Two models of different sizes are available.

Colección de bancos, con respaldo y apoyabrazos, realizados con varillas de acero, dotados de refuerzos en chapa de acero y de dos o tres soportes. Disponibles dos modelos de diferentes tamaños.

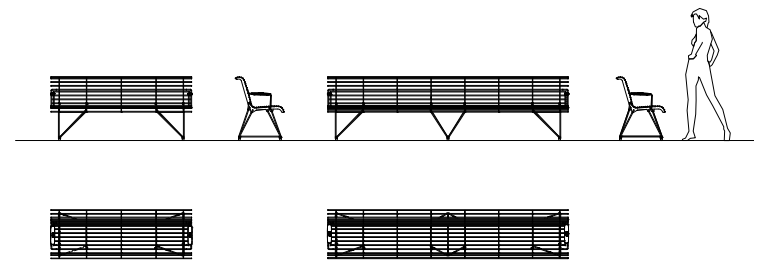





Three-dimensional decorative elements, letter or number shaped, made of stainless steel sheet with stainless steel base. They are only available in "sans serif" font.

Elementos decorativos tridimensionales, en forma de letras o números, realizados en chapa de acero Inox con base en acero Inox. Disponibles en un único font "sans serif".



## LETTERE

Designer:	Staubach & Kuckertz
Dimensions and weight Dimensiones y peso:	A/V 597 mm - B/C/D/E/G/H/J/O/P/R/S/T/ U/Z/2/3/5/6/7/8/9/0 450 mm F/I 200 mm - K 486 mm - L 370 mm M 738 mm - N 504 mm - Q 500 mm X 540 mm - Y 499 mm - 1 275 mm 4 550 mm da 16 a 45 kg
	H 900 mm P 250 mm
Materials/Materiales:	Powder coated stainless steel Acero Inox pintado
Fixing/Fijación:	Pre-drilled for anchors Predisposición para tacos

LORENZ





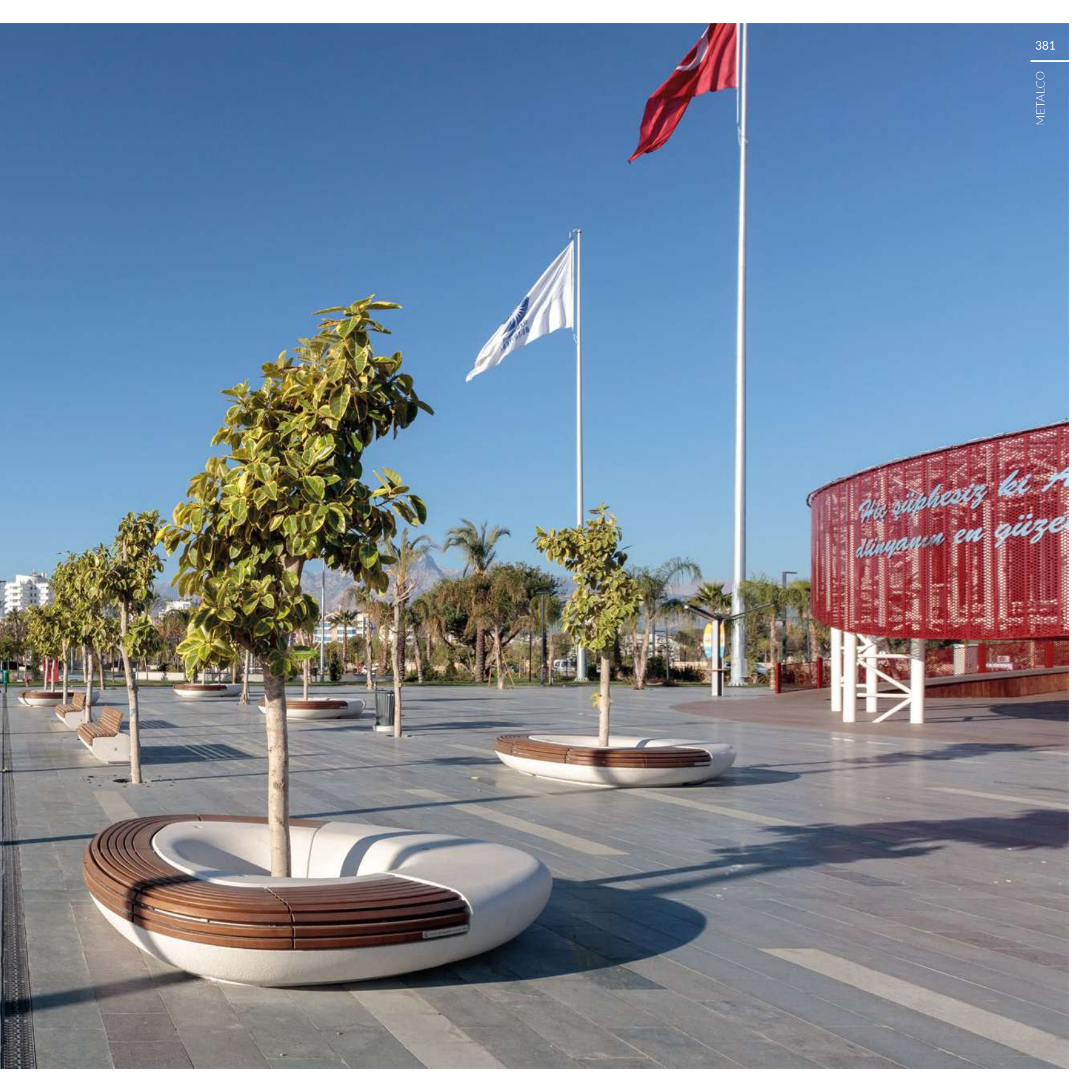



L 1000 PP

L 1000 PA

L 2200 PP

L 2200 PA

LS

## LORENZ

Designer: Pio & Tito Toso + Massimo Tasca +  
Mattia Li Pomi

Dimensions and weight  
Dimensiones y peso:

L 1000 PP   L 1000 PA	
1000x750 mm H 460 mm	
L 1000 PP	654 kg
L 1000 PA	652 kg

L 2200 PP   L 2200 PA	
2200x750 mm H 460 mm	
L 2200 PP	1361 kg
L 2200 PA	1356 kg

LS	
2070x1200 mm H 460 mm	
1270 kg	

Materials/Materiales: PDM (Reconstituted Stones) + Hardwood  
PDM (Piedras Reconstituidas) + Madera dura

Finishes/Acabados: PDM Sandblasted  
PDM Tratado con chorro de arena

Fixing/Fijación: Freestanding  
Apoyo

Collection of modular monolithic seats made of PDM (Reconstituted Stones). The following models are available: six linear modules, available in two lengths, with or without wooden backrest, with wooden seat, positioned along the inner or outer side; a curved module, without backrest, with wooden seat positioned along the outer side.

Colección de asientos monolíticos y modulares realizados en PDM (Piedras Reconstituidas). Disponibles los siguientes modelos: seis módulos lineales, disponibles en dos largos, con o sin respaldo de madera, con asiento, también de madera, posicionados en el lado interno o externo; un módulo curvo sin respaldo, con asiento de madera, posicionado en el lado externo.





L 1000 SP



L 1000 SA



L 2200 SP



L 2200 SA

## LORENZ

Designer: Pio & Tito Toso + Massimo Tasca +  
Mattia Li Pomi

Anno/Année: 2014

Dimensions and weight  
Dimensiones y peso:

L 1000 SP   L 1000 SA	1000x750 mm H 750 mm h 460 mm
L 1000 SP	667 kg
L 1000 SA	664 kg

L 2200 SP   L 2200 SA	2200x750 mm H 750 mm h 460 mm
L 2200 SP	1387 kg
L 2200 SA	1383 kg

Materials/Materiales: PDM (Reconstituted Stones) + Hardwood  
PDM (Piedras Reconstituidas) + Madera dura

Finishes/Acabados: PDM Sandblasted  
PDM Tratado con chorro de arena

Fixing/Fijación: Freestanding  
Apoyo

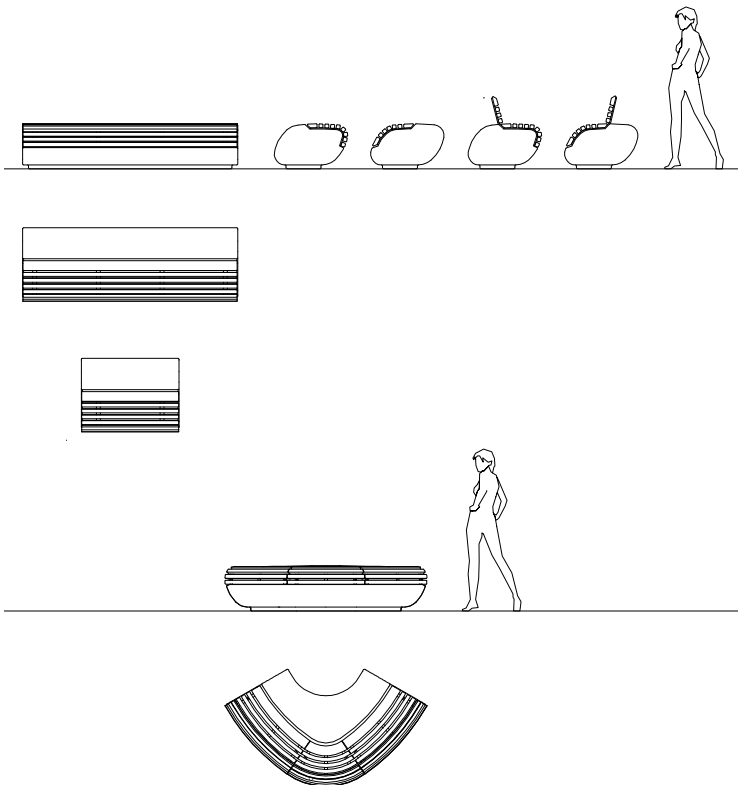

LORENZ









TREE LINE





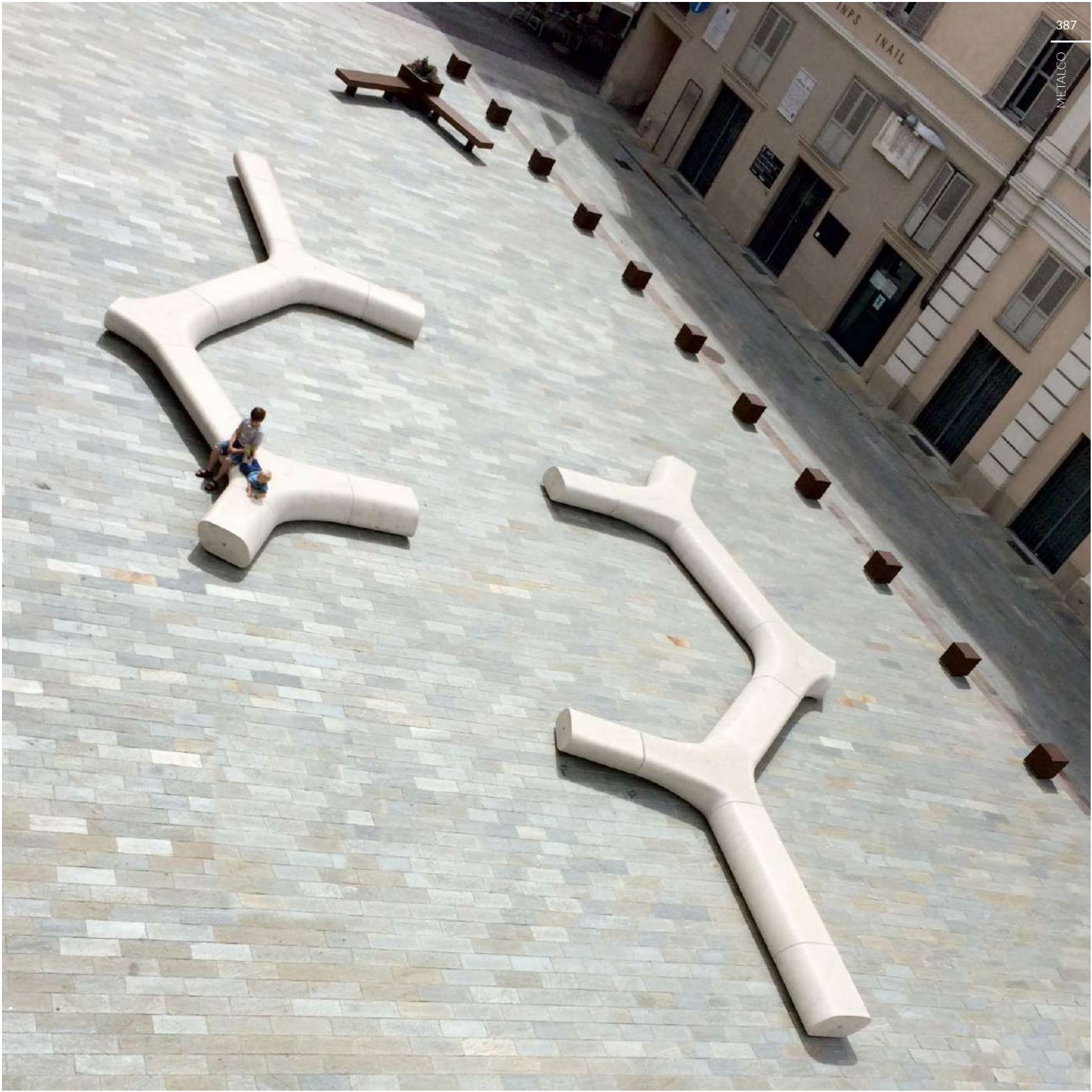



TREE LINE

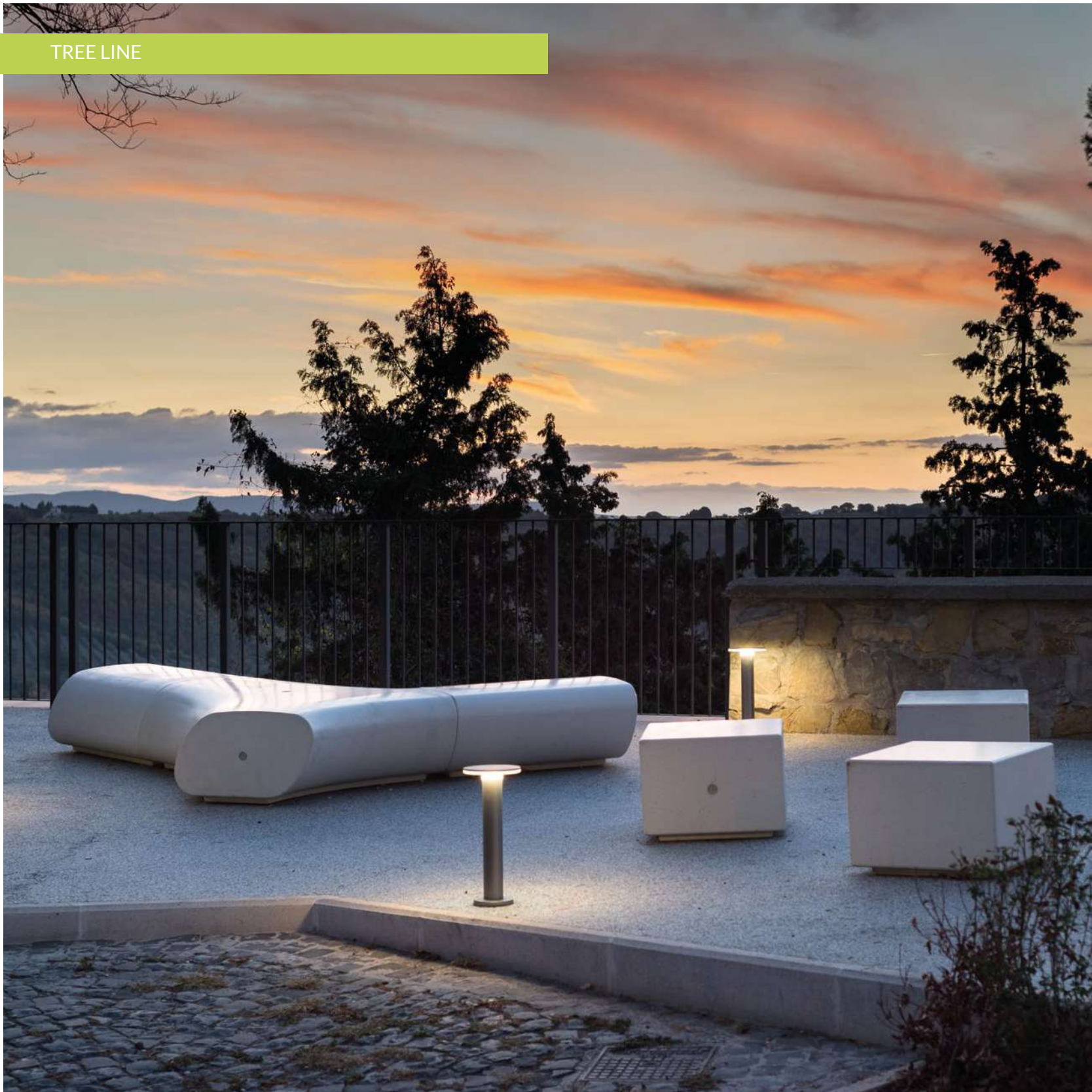





L 1000



L 2200



Y

Collection of modular monolithic seats made of PDM (Reconstituted Stones). Three versions are available: two linear with different length and one "Y" shaped. Each model can be installed individually or in composition with the other elements of the Tree Line or the Lorenz collections.

Colección de asientos modulares y monolíticos, realizados en PDM (Piedras Reconstituidas). Disponibles tres versiones: dos lineales con diferente largo y uno con forma de "Y". Cada modelo puede ser instalado individualmente o en composición, combinándolo con otros elementos de la colección Tree Line o Lorenz.

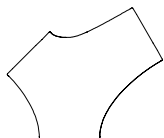

## TREE LINE

Designer:	Pio & Tito Toso
Dimensions and weight Dimensiones y peso:	<p><b>TREE LINE L1000</b> 1000x750 mm H 460 mm 708 kg</p> <p><b>TREE LINE L2200</b> 2200x750 mm H 460 mm 1562 kg</p> <p><b>TREE LINE Y</b> 1915x1625 mm H 460 mm 1782 kg</p>
Materials/Materiales:	PDM (Reconstituted Stones) PDM (Piedras Reconstituidas)
Finishes/Acabados:	Sandblasted Tratado con chorro de arena
Fixing/Fijación:	Freestanding Apoyo

TREE LINE C | 120°







Module of the Tree Line collection composed of a curved monolithic seat, made of PDM (Reconstituted Stones). It can be installed in combination with the other linear elements of the Tree Line or the Lorenz collections or in composition to create a planter.

Módulo de la colección Tree Line, constituido por un asiento monolítico curvo, realizado en PDM (Piedras Reconstituidas). Puede ser instalado combinándolo con otros elementos lineales de la colección Tree Line o Lorenz, o en composición para crear una jardinera.

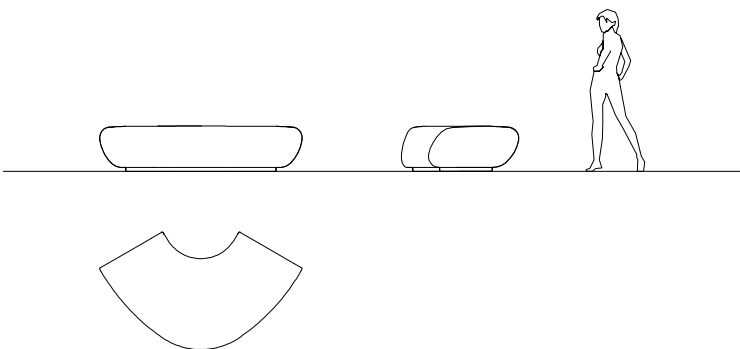

C - 120°

## TREE LINE C | 120°

Designer:	Pio & Tito Toso
Dimensions and weight Dimensiones y peso:	2070x1200 mm H 460 mm Ri 888 mm 1488 kg
Materials/Materiales:	PDM (Reconstituted Stones) PDM (Piedras Reconstituidas)
Finishes/Acabados:	Sandblasted Tratado con chorro de arena
Fixing/Fijación:	Freestanding Apoyo

TREE LINE ACCESSORIES







TRL 15

TRL 25

The L1000 model can be equipped with a backrest and the L2200 model can be equipped with one or two backrests in PDM (Reconstituted Stones), positioned in line or alternate.

El modelo L1000 puede alojar un respaldo y el modelo L2200 puede alojar uno o dos respaldos en PDM (Piedras Reconstituidas), pudiendo posicionarse en línea o alternados.

## TREE LINE ACCESSORIES

Designer:	Pio & Tito Toso	
Dimensions and weight	L 900 mm P 135 mm H 365 mm	
Dimensiones y peso:	TRL 15	1670 kg
	TRL 25	1779 kg
Materials/Materiales:	PDM (Reconstituted Stones) PDM (Piedras Reconstituidas)	
Finishes/Acabados:	Sandblasted Tratado con chorro de arena	
Fixing/Fijación:	Freestanding Apoyo	

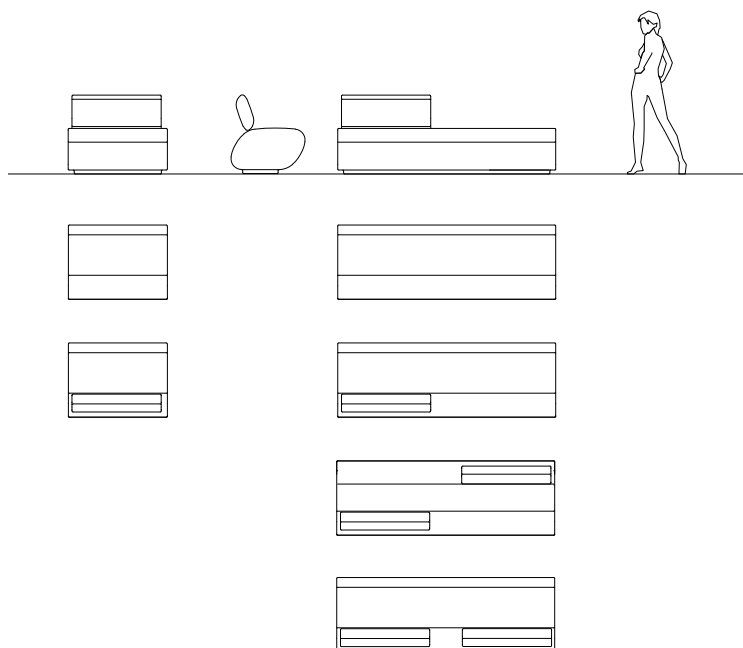

ANASTASIO, MAKATITE, REALGAR







ANASTASIO



MAKATITE



REALGAR

Collection of modular benches in PDM (Reconstituted Stones), available in three versions. Anastasio is a monolithic seat with inclined sides. Makatite is a monolithic seat, equipped with a backrest. Realgar is a monolithic seat, equipped with a platform. The benches can be installed individually or in composition.

Colección de bancos modulares en PDM (Piedras Reconstituidas), disponibles en tres versiones. Anastasio consiste en un elemento monolítico con lados inclinados y una superficie que hace de asiento. Makatite consiste en un elemento monolítico que actúa como asiento, dotado de respaldo. Realgar consiste en un elemento monolítico que actúa como asiento y dotado de una plataforma. Los bancos pueden instalarse individualmente o en composición.

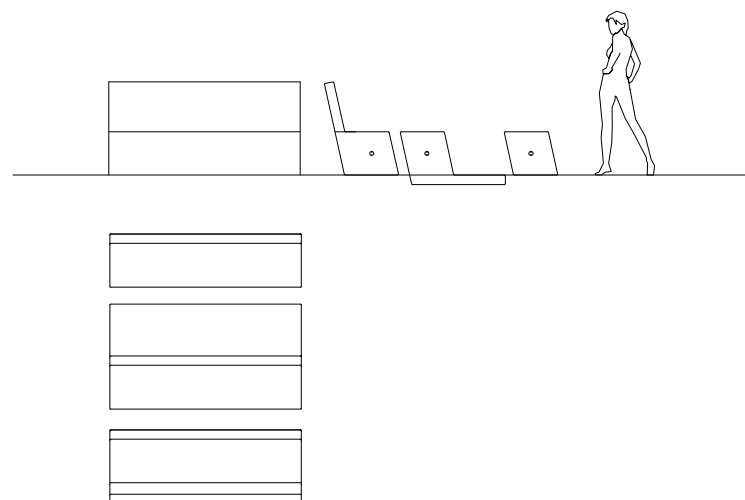

## ANASTASIO | MAKATITE | REALGAR

Designer:	Stefano Alonzi + Gaetano De Napoli + Adriano Venudo + Valter Tronchin
Dimensions and weight Dimensiones y peso:	<p><b>ANASTASIO</b> 2000x556 mm H 450 mm 1020 kg</p> <p><b>MAKATITE</b> 2000x771 mm H 974 mm h 450 mm 1500 kg</p> <p><b>REALGAR</b> 2000x1097 mm H 550 mm h 450 mm 1500 kg</p>
Materials/Materiales:	PDM (Reconstituted Stones) PDM (Piedras Reconstituidas)
Finishes/Acabados:	Brushed top + Sandblasted sides Parte superior trabajada con púas rígidas + Laterales tratados con chorro de arena
Fixing/Fijación:	Freestanding Apoyo







B



S



W

Backrest made of laser cut steel sheet with geometric patterns, available in linear or inclined version, depending on the side of its position on the monolith, or in wood with steel tube support brackets.

Respaldo en chapa de acero, perforada en laser con motivos geométricos, disponibles en versión lineal o inclinada, según el lado en el que se posicione el monolito o en madera con soportes de sujeción en tubo de acero.

## ANASTASIO ACCESSORIES

Designer: **Stefano Alonzi + Gaetano De Napoli + Adriano Venudo + Valter Tronchin**

Dimensions and weight / Dimensiones y peso: **B**  
100x493 mm H 911 mm 20 kg

**S**  
100x493 mm H 955 mm 21 kg

**W**  
100x1993 mm H 890 mm 67 kg

Materials/Materiales: **Powder coated steel o Hardwood  
Acero pintado o Madera dura**

Fixing/Fijación: **Pre-drilled for anchors  
Predisposición para tacos**

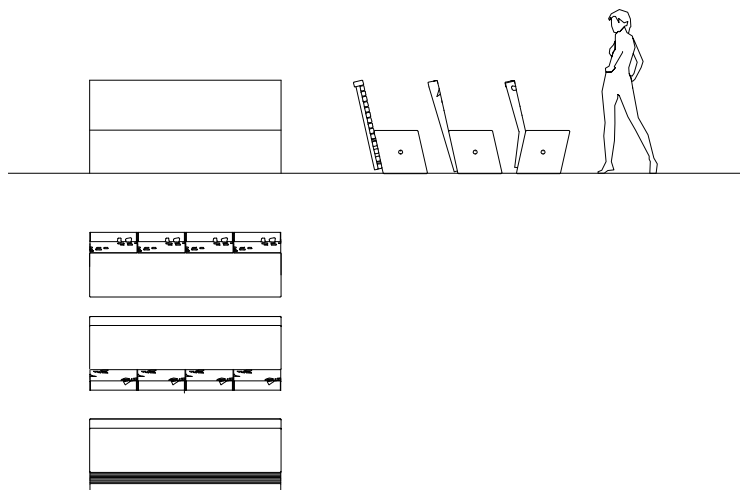

MOOD COLLECTION







MSD



MSDT

Collection of steel benches with backrest and double-sided seat. The MSD model is made from a single sheet laser cut, with circular hole decorations. The MSDT model is composed of a double seat in small tubes and two supports in metal sheet.

Colección de bancos con respaldo y asientos bilaterales, realizados en acero. El modelo MSD está formado por una sola chapa cortada a láser, con decoraciones consistentes en orificios circulares. El modelo MSDT está formado por una superficie plana realizada con tubos que sirven como asiento y por dos soportes en chapa.

## MOOD MSD | MSDT

Designer:	Staubach & Kuckertz	
Dimensions and weight	1480x960 mm H 755 mm h 455 mm	
Dimensiones y peso:	MSD	83 kg
	MSDT	95 kg
Materials/Materiales:	Powder coated steel Acero pintado	
Fixing/Fijación:	Pre-drilled for anchors Predisposición para tacos	

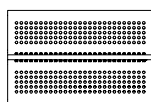
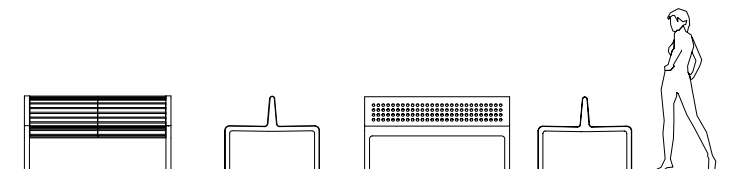



MPT



MP

## MOOD MPT | MP

Designer:	Staubach & Kuckertz		
Dimensions and weight	1480x505 mm H 455 mm		
Dimensiones y peso:	MPT	28 kg	
	MP	34 kg	
Materials/Materiales:	Powder coated steel Acero pintado		
Fixing/Fijación:	Pre-drilled for anchors Predisposición para tacos		

Collection of steel benches without backrest. The MP model is made from a single sheet laser cut, with circular hole decorations. The MPT model is composed of a seat in small tubes and two supports in metal sheet.

Colección de bancos sin respaldo, realizados en acero. El modelo MP está formado por una sola chapa cortada a láser, con decoraciones consistentes en orificios circulares. El modelo MPT está formado por una superficie plana realizada con tubos que sirven como asiento y por dos soportes en chapa.

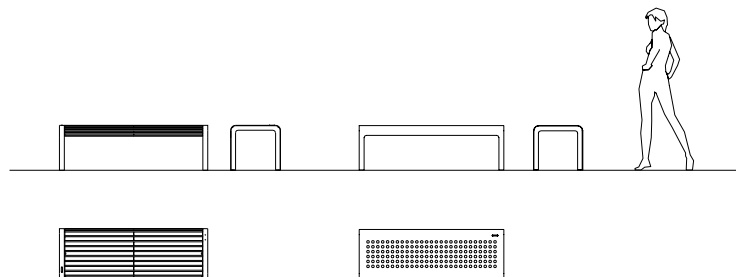





MST



MS

Collection of steel benches with backrest. The MS model is made from a single sheet laser cut, with circular hole decorations. The MST model is composed of a seat in small tubes and two supports in metal sheet.

Colección de bancos con respaldo, realizados en acero. El modelo MS está formado por una sola chapa cortada a láser, con decoraciones consistentes en orificios circulares. El modelo MST está formado por una superficie plana realizada con tubos que sirven como asiento y por dos soportes en chapa.

## MOOD MST | MS

Designer:	Staubach & Kuckertz	
Dimensions and weight	1480x550 mm H 755 mm h 455 mm	
Dimensiones y peso:	MST	38 kg
	MS	46 kg
Materials/Materiales:	Powder coated steel Acero pintado	
Fixing/Fijación:	Pre-drilled for anchors Predisposición para tacos	

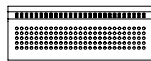
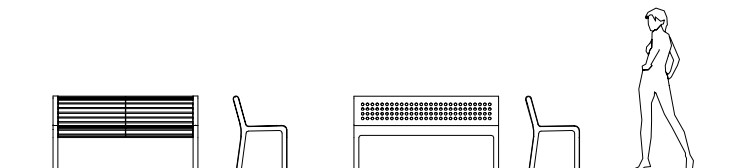

SPLASH







Monolithic seat with organic shape entirely made of HPC (High Performance Concrete).

Asiento con estructura monolítica totalmente realizado en HPC (High Performance Concrete).

## SPLASH

Designer:	Massimo Tasca
Dimensions and weight Dimensiones y peso:	1960x1745 mm H 400 mm 990 kg
Materials/Materiales:	HPC (High Performance Concrete)
Finishes/Acabados:	Velluto - Natural smooth Velluto - Liso natural
Fixing/Fijación:	Freestanding Apoyo

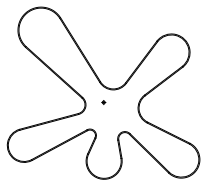
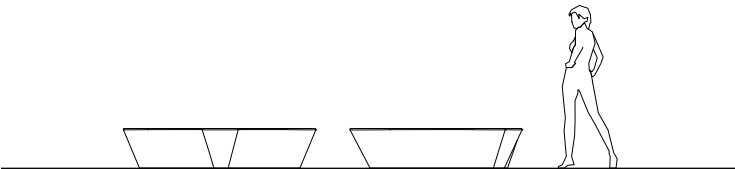

SPLASH





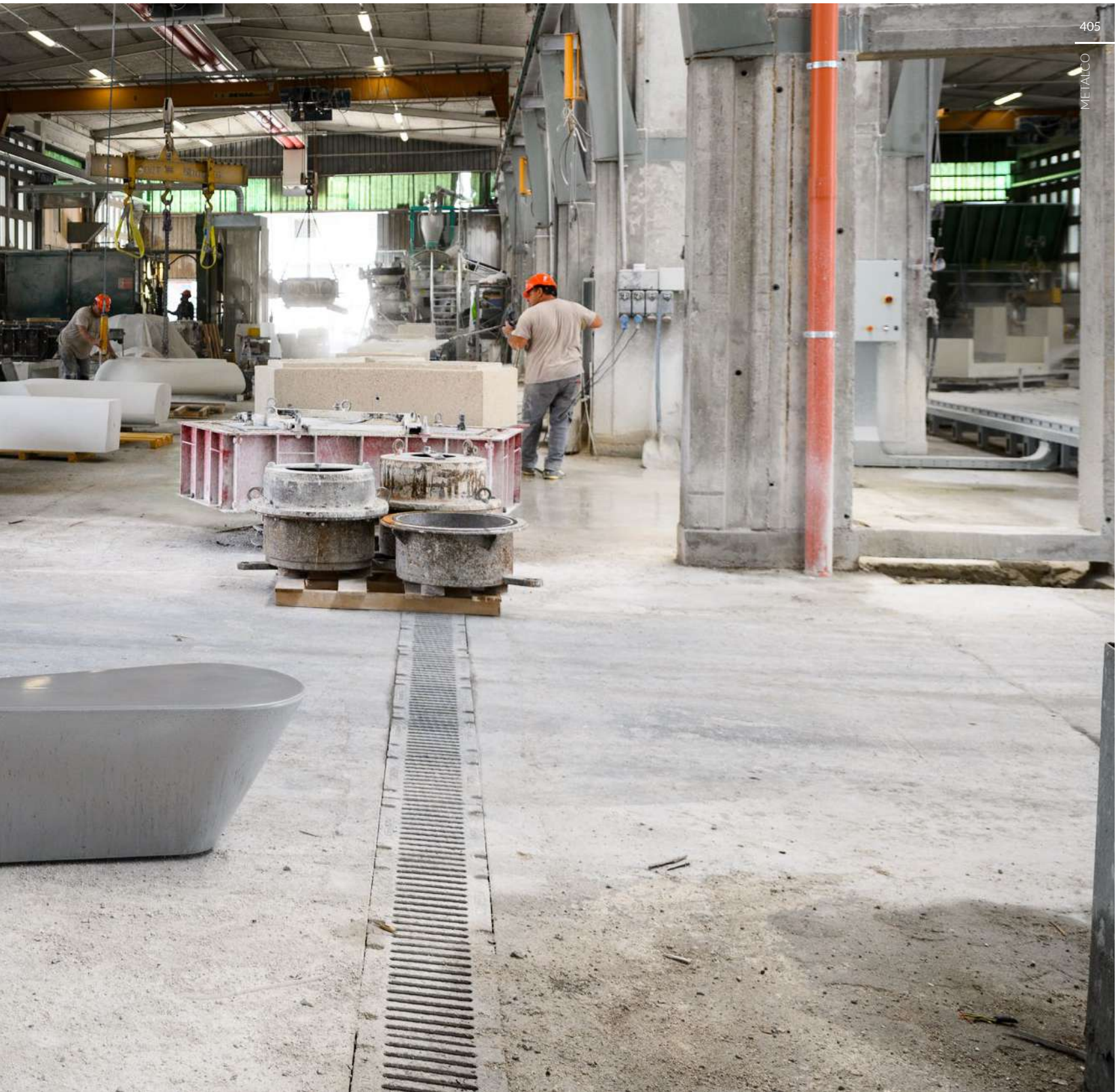



NATURAL PUZZLE







Modular monolithic seat, with organic shape, in HPC (High Performance Concrete) with steel tube supports. The shape of the seat is designed to aggregate several elements in a single composition.

Asiento modular monolítico, con forma orgánica, en HPC (High Performance Concrete) con soportes en tubo de acero. La forma del banco está diseñada para poder agregar múltiples elementos idénticos en una única composición.

## NATURAL PUZZLE

Designer:	Pio & Tito Toso
Dimensions and weight Dimensiones y peso:	2150x2160 mm H 423 mm (+ 250 mm) 680 kg
Materials/Materiales:	HPC (High Performance Concrete) + Powder coated steel HPC (High Performance Concrete) + Acero pintado
Finishes/Acabados:	HPC Velluto - Natural smooth HPC Velluto - Liso natural
Fixing/Fijación:	Pre-drilled for anchors or Below ground installation Predisposición para tacos o Cimentación

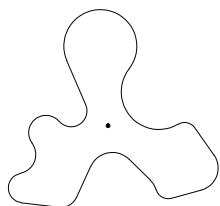
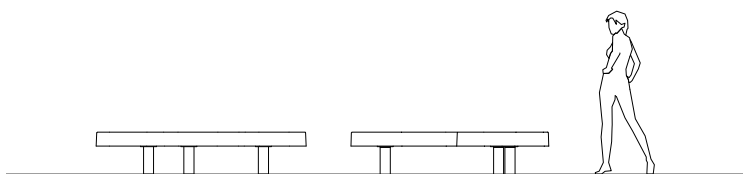

PAD







Bench without a backrest, featuring a steel tube frame, four uprights and a High Performance Concrete seat that is decorated with a quilt design and has holes to let rain water drain away.

Banco sin respaldo formado por una estructura en tubo de acero, dotado de cuatro soportes verticales y por una superficie que hace de asiento en HPC (High Performance Concrete), decorado simulando un edredón, dotado de orificios para facilitar el desagüe.

## PAD

Designer:	Staubach & Kuckertz	
Dimensions and weight Dimensiones y peso:	1400x700 mm H 462 mm	151 kg
Materials/Materiales:	HPC (High Performance Concrete) + Powder coated Stainless steel HPC (High Performance Concrete) + Acero Inox pintado	
Finishes/Acabados:	HPC Velluto - Natural smooth HPC Velluto - Liso natural	
Fixing/Fijación:	Freestanding with pedestals or Installation with threaded bars Apoyo con pies o Cimentación con varillas roscadas	

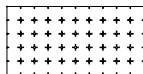
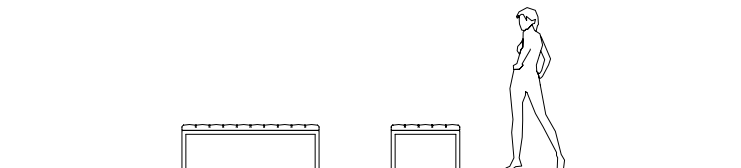



## NUVOLA

Designer:	Alfredo Tasca		
Dimensions and weight Dimensiones y peso:	NUVOLA table   mesa		
	1840x714 mm H 710 mm		
	Hardwood   Madera dura	75 kg	
	Larch   Alerce	63 kg	
Materials/Materiales:	Powder coated steel or Corten steel + Hardwood or Larch wood Acero pintado o Acero Corten + Madera dura ou Alerce		
Fixing/Fijación:	Pre-drilled for anchors Predisposición para tacos		

Collection of benches composed of a wooden seat and a supporting structure in steel plate. The benches are available in three versions: with wooden backrest, without backrest, with half wooden backrest and double-sided seat. The collection is complete with table composed of a supporting structure in steel plate and wooden top.

Colección de bancos formados por una superficie de madera que hace de asiento y por una estructura portante en placa de acero. Los bancos están disponibles en tres versiones: con respaldo de madera, sin respaldo, con medio respaldo de madera y asiento bilateral. La colección está compuesta de mesa formada por una estructura portante en placa de acero y superficie de madera.

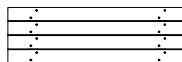
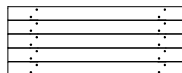
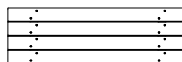
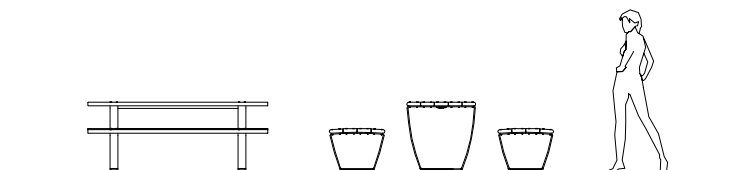





table | mesa



bench | banco



double bench | banco doble



without backrest | sin respaldo

## NUVOLA

Designer:

Alfredo Tasca

Dimensions and weight  
Dimensiones y peso:

NUVOLA bench | banco  
1840x595 mm H 750 mm h 442 mm  
67 kg

NUVOLA double bench | banco doble  
3000x717 mm H 755 mm h 442 mm  
113 kg

NUVOLA without backrest | sin respaldo  
1840x574 mm H 442 mm  
54 kg

Materials/Materiales:

Powder coated steel or Corten steel +  
Hardwood or Larch wood  
Acero pintado o Acero Corten + Madera dura  
ou Alerce

Fixing/Fijación:

Pre-drilled for anchors  
Predisposición para tacos

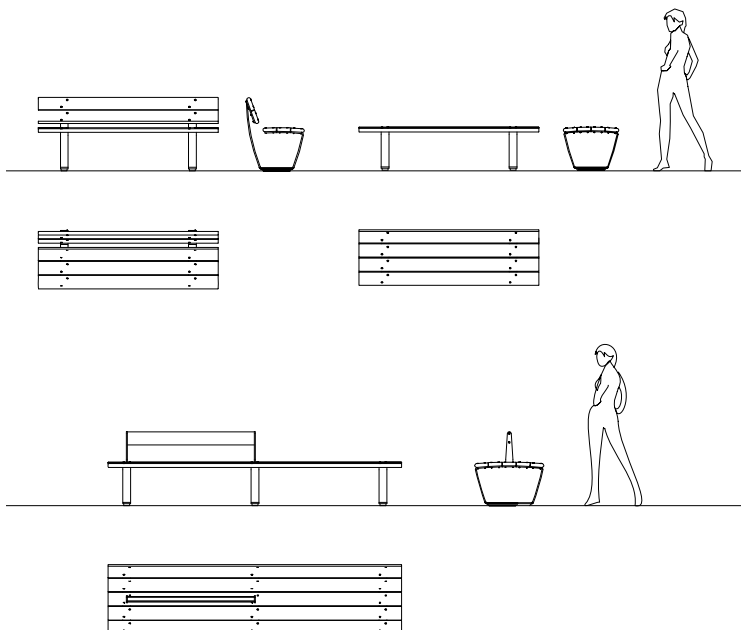

EDGE COLLECTION









## EDGE SMART

Designer:	Indio Da Costa AUDT
Dimensions and weight Dimensiones y peso:	4115x525 mm H 455 mm 650 kg
Materials/Materiales:	HPC (High Performance Concrete) + Stainless steel HPC (High Performance Concrete) + Acero Inox
Finishes/Acabados:	HPC Velluto - Natural smooth HPC Velluto - Liso natural
Fixing/Fijación:	Freestanding or Pre-drilled for anchors Apoyo o Predisposición para tacos
Accessories/Accesorios:	It can be equipped with electric charging of electronic devices (USB) puede equiparse para la carga eléctrica de dispositivos electrónicos (USB)

Collection of benches without backrest in HPC (High Performance Concrete), composed of a structure with two cantilevered seats joined by a steel sheet element. Two versions are available: with or without USB charging socket.

Colección de bancos sin respaldo en HPC (High Performance Concrete), constituidos por una estructura con dos asientos en voladizo unidos por un elemento en chapa de acero. Disponibles en dos versiones: con o sin conexión USB.

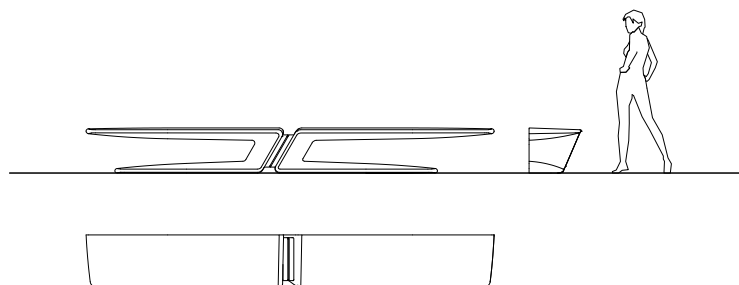





Collection of benches without backrest in HPC (High Performance Concrete) composed of a structure with cantilevered seats. Two models are available: one with right seat, the other with left seat.

Colección de bancos sin respaldo en HPC (High Performance Concrete), constituidos por una estructura con asientos en voladizo. Disponibles en dos versiones: una con el asiento a la derecha, la otra con el asiento a la izquierda.

## EDGE SX | DX

Designer:	Indio Da Costa AUDT
Dimensions and weight Dimensiones y peso:	1990x525 mm H 455 mm 310   320 kg
Materials/Materiales:	HPC (High Performance Concrete)
Finishes/Acabados:	Velluto - Natural smooth Velluto - Liso natural
Fixing/Fijación:	Freestanding or Pre-drilled for anchors Apoyo o Predisposición para tacos

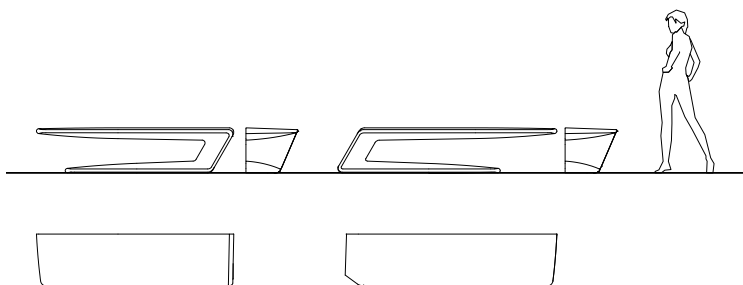

OCEAN

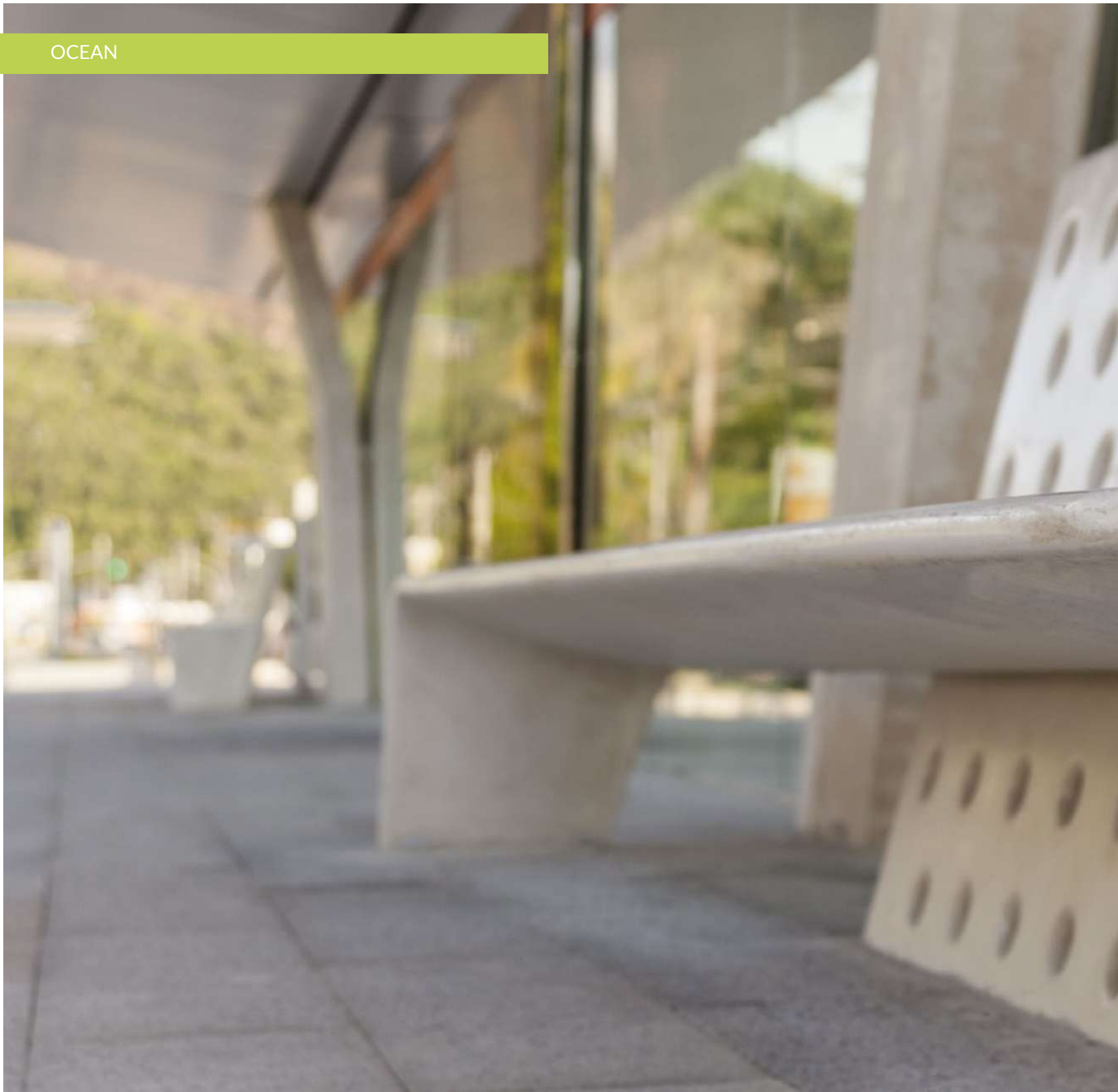



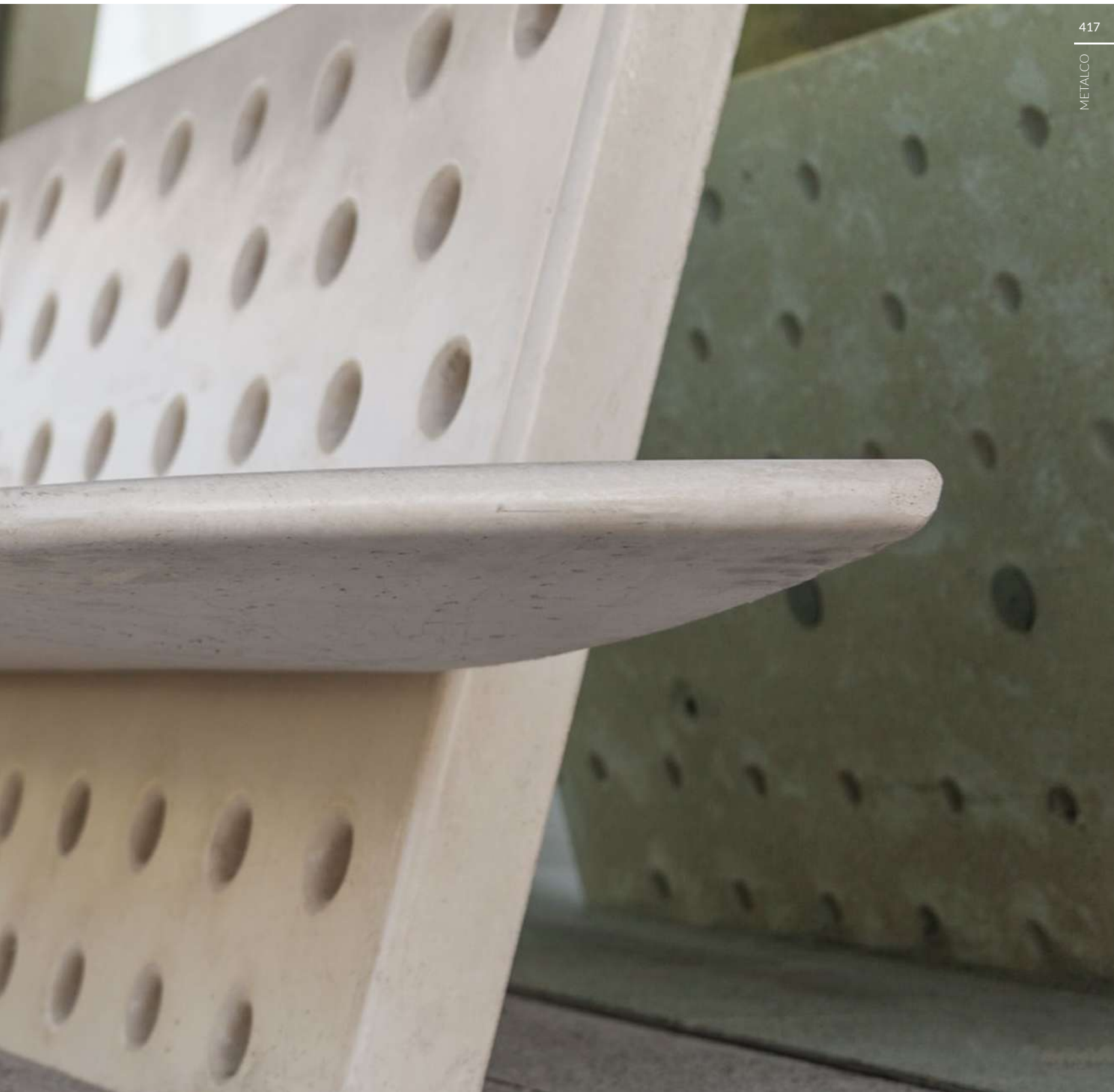

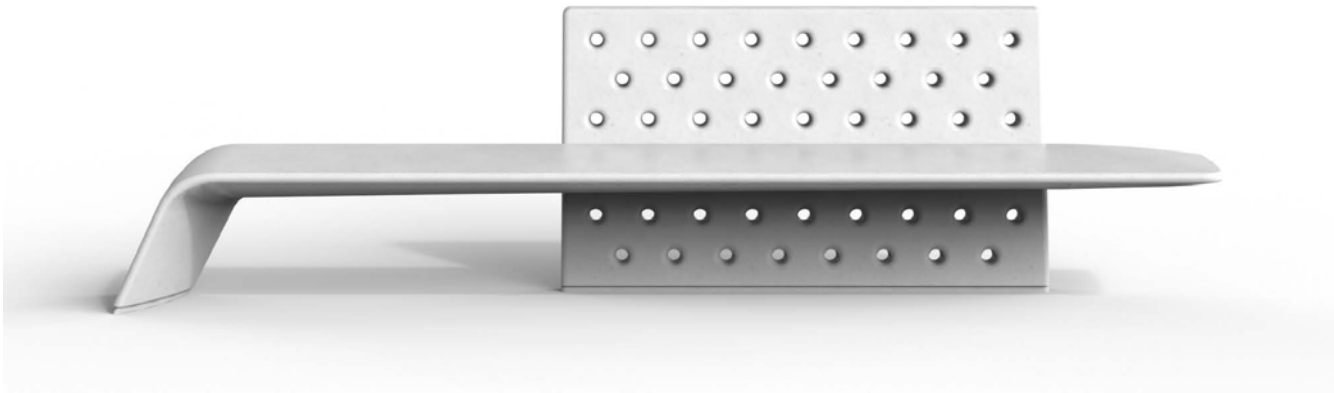

## OCEAN HPC

Designer:	Indio Da Costa AUDT
Dimensions and weight Dimensiones y peso:	3090x655 mm H 820 mm 600 kg
Materials/Materiales:	HPC (High Performance Concrete)
Finishes/Acabados:	Velluto - Natural smooth Velluto - Liso natural
Fixing/Fijación:	Below ground installation Cimentación

Cantilevered bench made of HPC (High Performance Concrete), equipped with a monolithic backrest decorated with holes which occupies half of the seat.

Banco en voladizo en HPC (High Performance Concrete), con respaldo monolítico, decorado con orificios, que ocupan la mitad del asiento.

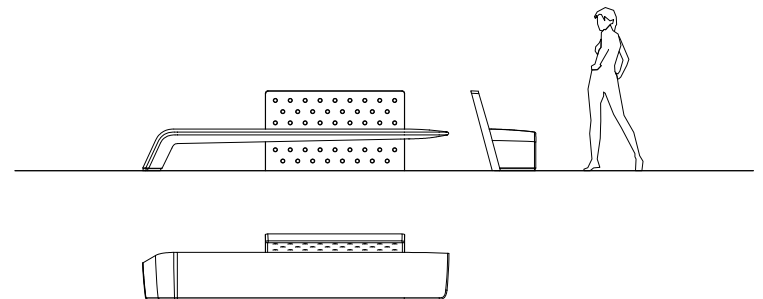



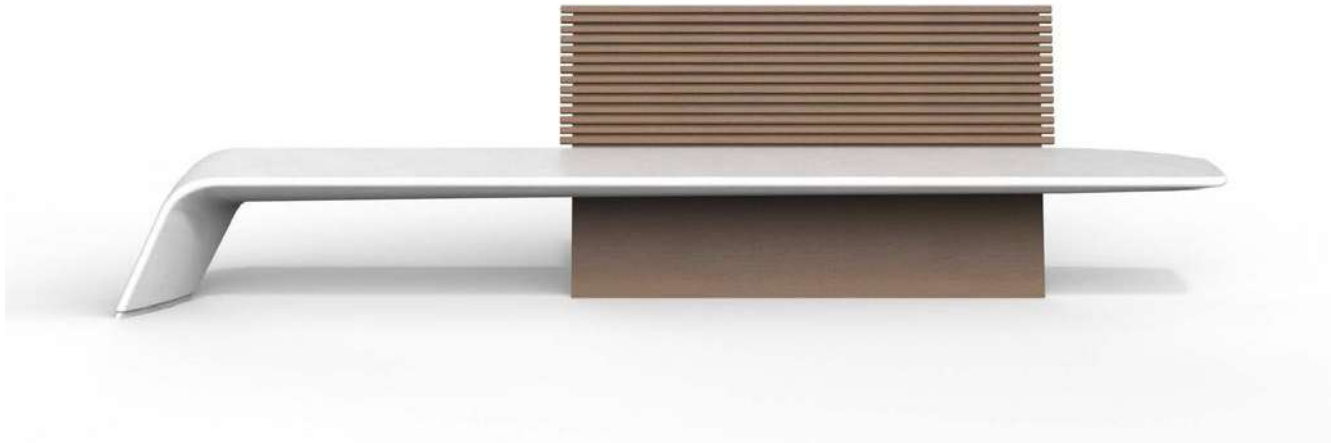

Cantilevered bench made of HPC (High Performance Concrete), equipped with a steel sheet backrest covered in wood, which occupies half of the seat.

Banco en voladizo en HPC (High Performance Concrete), con respaldo en chapa de acero revestido de madera, que ocupa la mitad del asiento.

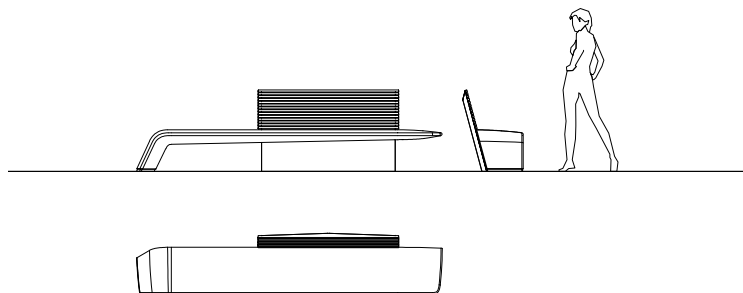

## OCEAN W

Designer:	Indio Da Costa AUDT
Dimensions and weight Dimensiones y peso:	3090x610 mm H 820 mm 370 kg
Materials/Materiales:	HPC (High Performance Concrete) + Hardwood HPC (High Performance Concrete) + Madera dura
Finishes/Acabados:	HPC Velluto - Natural smooth HPC Velluto - Liso natural
Fixing/Fijación:	Below ground installation Cimentación



## UM

Designer:	Indio Da Costa AUDT
Dimensions and weight Dimensiones y peso:	2190x620 mm H 445 mm 85 kg
Materials/Materiales:	UHPC (Ultra High Performance Concrete) + Hardwood UHPC (Ultra High Performance Concrete) + Madera dura
Finishes/Acabados:	UHPC Alfa - Natural smooth UHPC Alfa - Liso natural
Fixing/Fijación:	Installation with threaded bars Cimentación con varillas roscadas

Bench without backrest composed of a wooden top and supporting structure in UHPC (Ultra High Performance Concrete).

Banco sin respaldo dotado de una superficie de madera y estructura portante en UHPC (Ultra High Performance Concrete).

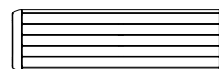



STAGE





Bench with double-sided seat and half wooden backrest, equipped with two supports made of UHPC (Ultra High Performance Concrete). The backrest, at the ends, has two decorative elements in UHPC (Ultra High Performance Concrete).

Banco con asiento bilateral y medio respaldo de madera, dotado de dos soportes en UHPC (Ultra High Performance Concrete). El respaldo, en sus extremidades, presenta dos elementos decorativos en UHPC (Ultra High Performance Concrete).

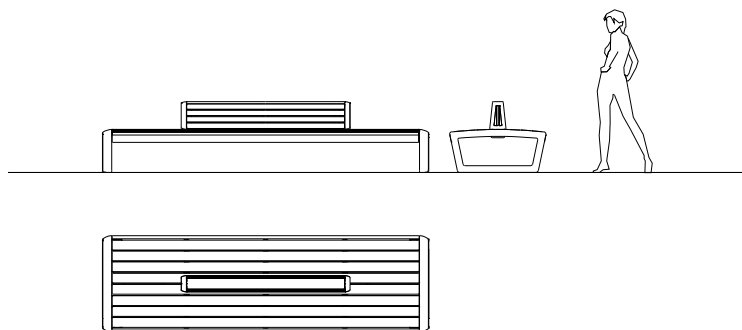

## STAGE

Designer:	Indio Da Costa AUDT
Dimensions and weight Dimensiones y peso:	3295x970 mm H 715 mm 200 kg
Materials/Materiales:	UHPC (Ultra High Performance Concrete) + Hardwood UHPC (Ultra High Performance Concrete) + Madera dura
Finishes/Acabados:	UHPC Alfa - Natural smooth UHPC Alfa - Liso natural
Fixing/Fijación:	Installation with threaded bars Cimentación con varillas roscadas
Accessories/Accesorios:	Electric charging of electronic devices (USB) Carga eléctrica de dispositivos electrónicos (USB)



PLATINUM COLLECTION





Collection of modular benches composed of a supporting structure made of steel tube, equipped with two or more supports in cast aluminium, on which are fixed single seats in steel, with or without backrest, decorated with laser. Compositions with two, three or four seats are available.

Colección de bancos modulares formados por una estructura portante realizada en tubo de acero, dotados de dos o más soportes en fundición de aluminio, sobre los cuales se fijan asientos monoplazas en acero, con o sin respaldo, decorados a láser. Disponibles composiciones formadas por dos, tres o cuatro plazas.

## PLATINUM COLLECTION

Designer:	Mattia Li Pomi
Dimensions and weight Dimensiones y peso:	2397x570 mm H 846 mm h 434 mm 89   68 kg
	1806x570 mm H 846 mm h 434 mm 66   50 kg
	1215x570 mm H 846 mm h 434 mm 46   36 kg

Materials/Materiales: Powder coated steel + Powder coated aluminum  
Acero pintado + Aluminio pintado

Fixing/Fijación: Freestanding with pedestals or Installation with threaded bars  
Apoyo con pies o Cimentación con varillas roscadas

Accessories/Accesorios: Central armrest in aluminum  
Apoyabrazo central en aluminio

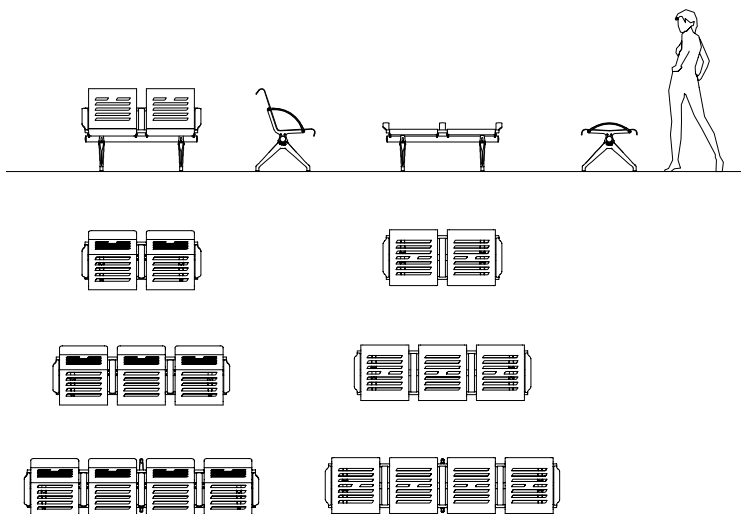



MISS W









MISS W





Collection of benches with backrest and seat made of wood, equipped with two crossed supports in steel plate. Two sizes are available.

Colección de bancos con respaldo y asiento de madera, dotados de dos soportes cruzados en placa de acero. Disponible en dos tamaños.

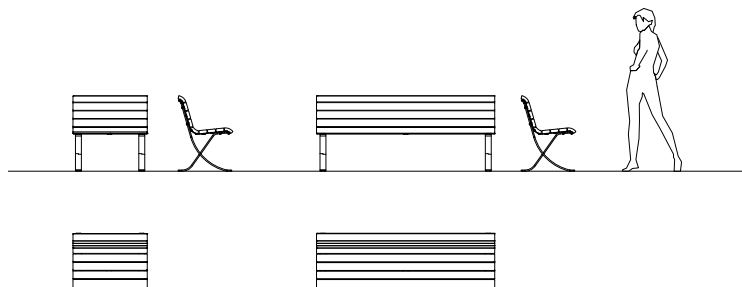

## MISS W

Designer:	Uwe Kuckertz
Dimensions and weight Dimensiones y peso:	1800x550 mm H 760 mm h 437 mm 58 kg
	750x550 mm H 760 mm h 437 mm 37 kg
Materials/Materiales:	Powder coated steel + Hardwood Acero pintado + Madera dura
Fixing/Fijación:	Pre-drilled for anchors Predisposición para tacos



MISS I



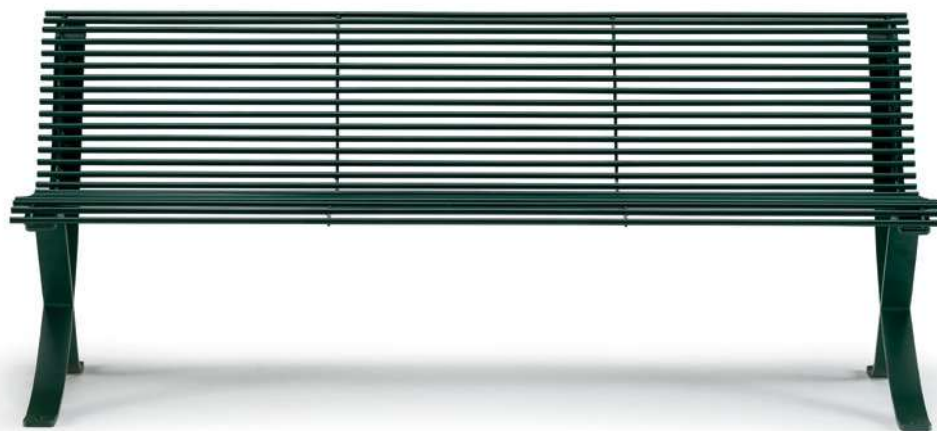

Collection of benches with backrest and seat made of steel rods, equipped with two crossed supports in steel plate. Two sizes are available.

Colección de bancos con respaldo y asiento en varillas de acero, dotadas de dos soportes cruzados en placa de acero. Disponible en dos tamaños.

## MISS I

Designer:	Uwe Kuckertz
Dimensions and weight Dimensiones y peso:	1800x550 mm H 750 mm h 427 mm 78 kg
	750x550 mm H 750 mm h 427 mm 46 kg
Materials/Materiales:	Powder coated steel Acero pintado
Fixing/Fijación:	Pre-drilled for anchors Predisposición para tacos

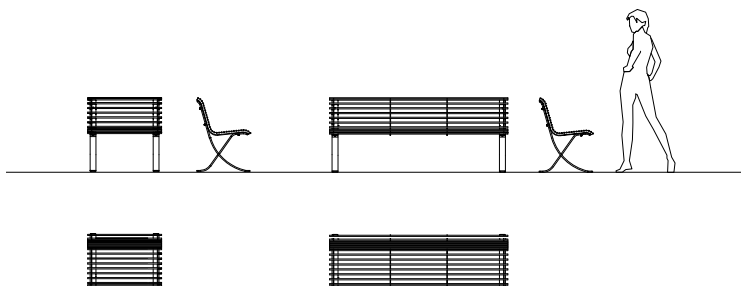



MISS I









RIVA







Collection of benches with wooden backrest and seat, composed of a supporting structure in cast aluminum. The bench is available in one, three or six seats, with or without armrests.

Colección de bancos con respaldo y asiento de madera dotados de una estructura portante en fundición de aluminio. Disponible con uno, tres o seis plazas, con o sin apoyabrazos.

## RIVA

Designer:	Staubach & Kuckertz
Dimensions and weight Dimensiones y peso:	3000x575 mm H 835 mm h 450 mm 52 kg
	1750x575 mm H 835 mm h 450 mm 32 kg
	750x575 mm H 835 mm h 450 mm 22 kg
Materials/Materiales:	Powder coated aluminum + Hardwood Aluminio pintado + Madera dura
Fixing/Fijación:	Installation with threaded bars Cimentación con varillas roscadas

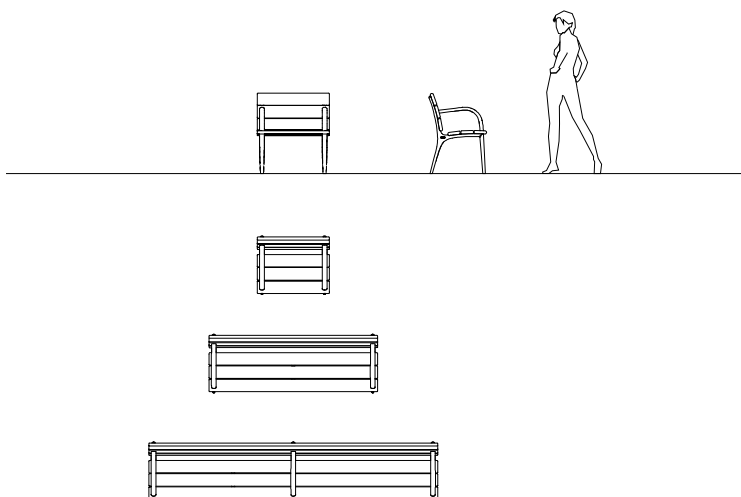



RIVOLA





Monolithic seat made of PDM (Reconstituted Stones). The element can be positioned on the ground in three different ways, one of which makes it usable as a chaise longue.

Asiento monolítico realizado en PDM (Piedras Reconstituidas). El elemento se puede posicionar en el terreno en tres modos diferentes, uno de los cuales permite que se pueda utilizar como "chaise longue".

## RIVOLA

Designer:	Studio Associato Pecoraro + Abate + Brunazzi
Dimensions and weight Dimensiones y peso:	180x645 mm H 420 mm 790 kg
Materials/Materiales:	PDM (Reconstituted Stones) PDM (Piedras Reconstituidas)
Finishes/Acabados:	Brushed top + Sandblasted sides Parte superior trabajada con púas rígidas + Laterales tratados con chorro de arena
Fixing/Fijación:	Freestanding Apoyo

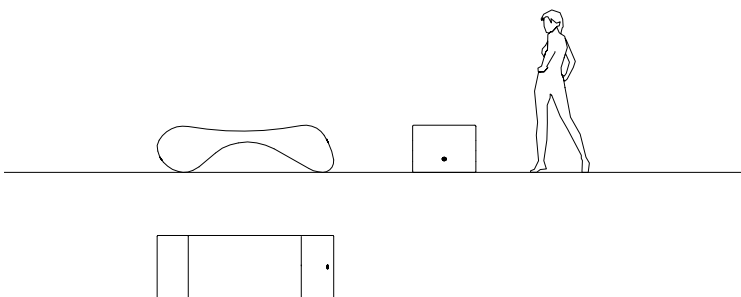



SEDIS | SEDIS TORSION

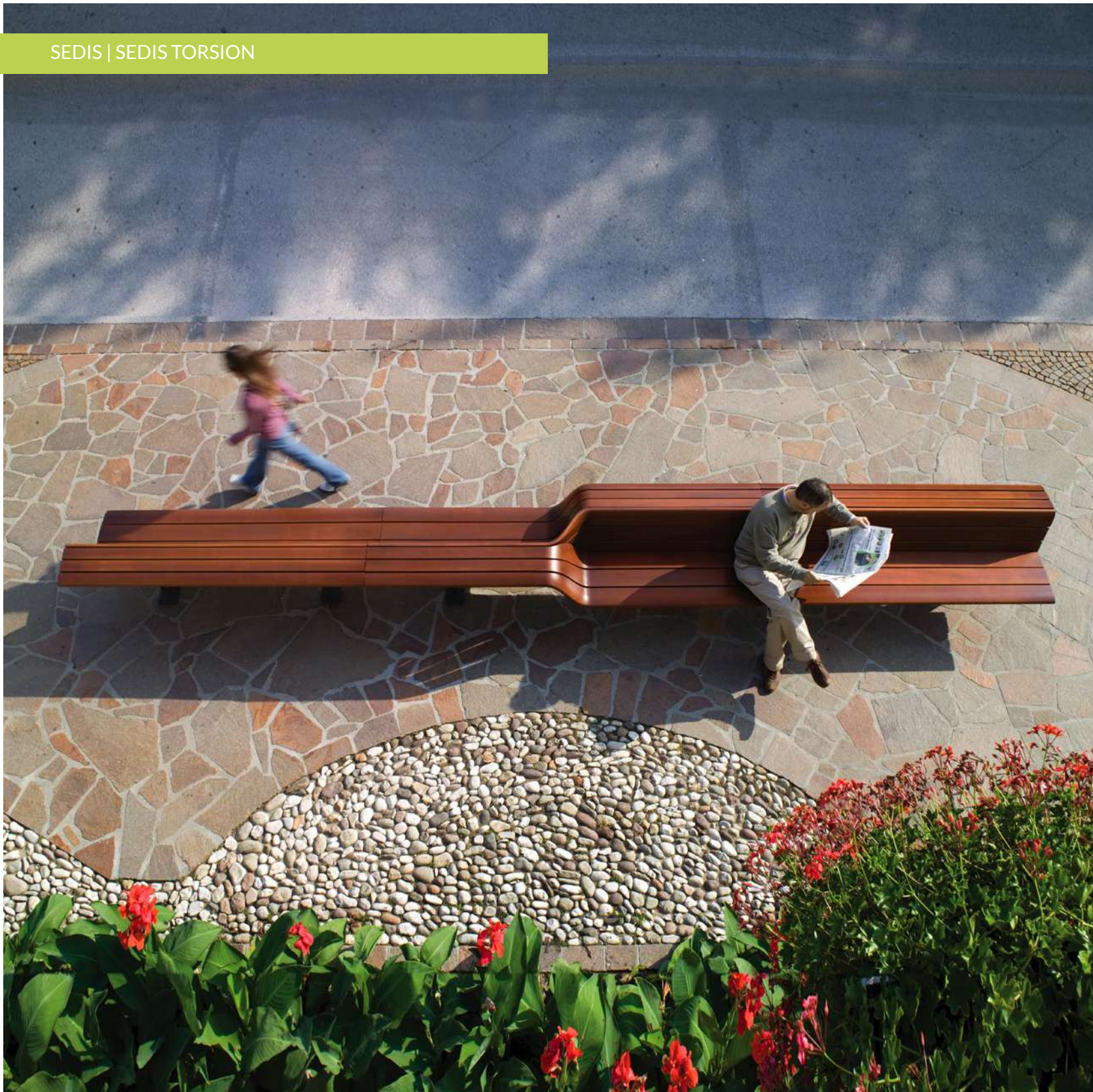



Collection of modular benches, with backrest, composed of two supports in cast aluminum. The seat and backrest are made of Okumè wood with slats of different section. The backrest has a particular shape that makes it usable, on the outside, as an leaning seat. Two versions are available: linear or Torsion, equipped with two seats with opposite backrests.

Colección de bancos modulares, con respaldo, formados por dos soportes en fundición de aluminio. La superficie que sirve de asiento y el respaldo están realizados en Okumè con listones moldeados de diferente forma. El respaldo tiene una forma particular que hace que la parte externa pueda utilizarse como asiento isquiático. Disponibles dos versiones: lineal o Torsion, esta última se compone de dos asientos con respaldos contrapuestos.

## SEDIS | SEDIS TORSION

Designer:	Antonio Citterio con Toan Nguyen
Dimensions and weight Dimensiones y peso:	<p><b>SEDIS</b> 2000x800 mm H 774 mm h 445 mm 74 kg</p> <p><b>SEDIS TORSION</b> 2600x800 mm H 774 mm h 445 mm 97 kg</p>
Materials/Materiales:	Okumè wood + Powder coated aluminum Madera de Okumè + Aluminio pintado
Fixing/Fijación:	Pre-drilled for anchors or Below ground installation Predisposición para tacos o Cimentación

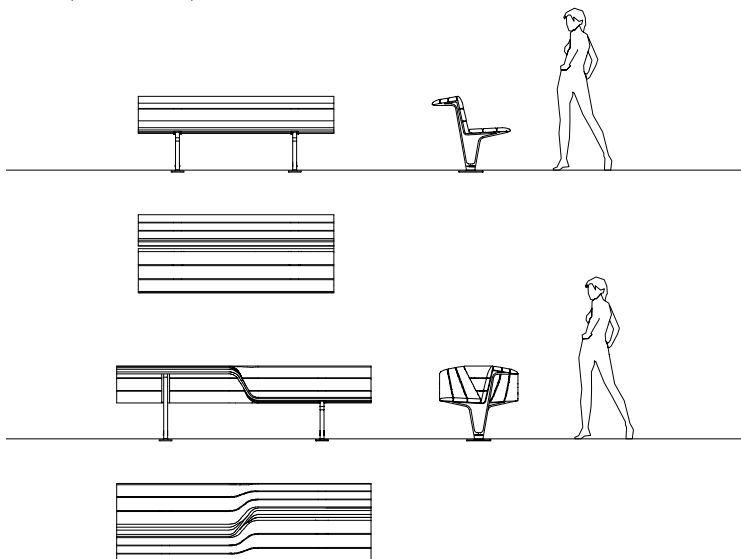





## TOSO

Designer:	Pio & Tito Toso	
Dimensions and weight Dimensiones y peso:	1800x570 mm H 450 mm	49 kg
Materials/Materiales:	Powder coated steel Acero pintado	
Fixing/Fijación:	Pre-drilled for anchors or Below ground installation Predisposición para tacos o Cimentación	

Bench without backrest composed of three bridge profiles in steel tube, interspersed with two other tube elements, connected together. The space created between the profiles allows to use the bench as a bike rack.

Banco sin respaldo compuesto por tres perfiles a forma de "puente", en tubo de acero, intercalados por otros dos elementos en tubo, unidos entre ellos. El espacio que queda entre los perfiles puede ser utilizado como aparcabicicletas.

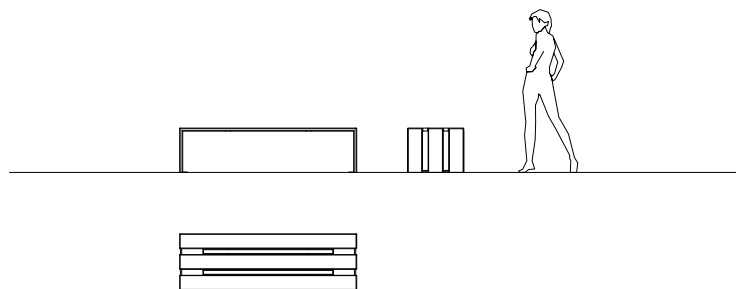



C | D

L

C + D

Collection of modular "L" shaped monolithic seats made of HPC (High Performance Concrete). Three versions are available: two without backrest, partially emptied inside, one single and equipped with backrest. They can be installed individually or in compositions.

Colección de asientos modulares y monolíticos en forma de "L", realizada en HPC (High Performance Concrete). Disponibles tres versiones: dos sin respaldo, aligeradas internamente, una monoplaza y con respaldo. Pueden ser instaladas individualmente o en composición.

## UP

Designer:	Pio & Tito Toso
Dimensions and weight Dimensiones y peso:	<p><b>L</b> 950x450 mm H 980 mm h 480 mm 600 kg</p> <p><b>C   D</b> 1031x950 mm H 480 mm 560 kg</p>
Materials/Materiales:	HPC (High Performance Concrete)
Finishes/Acabados:	Velluto - Natural smooth Velluto - Liso natural
Fixing/Fijación:	Freestanding Apoyo
Accessories/Accesorios:	LED lighting Iluminación LED

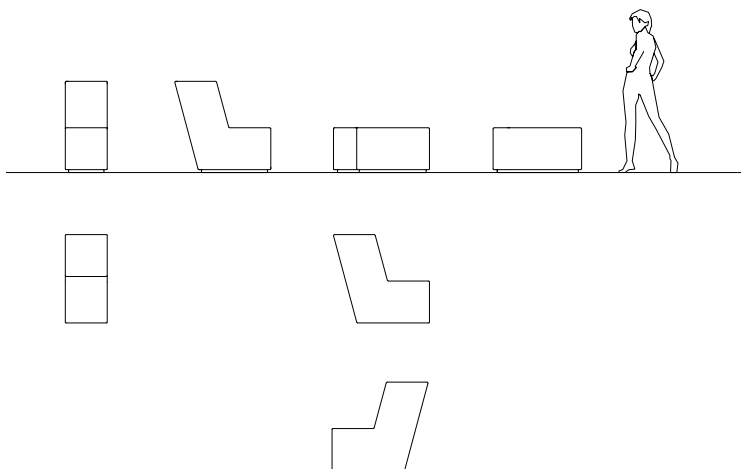



UP







TWIN + MIZAR S



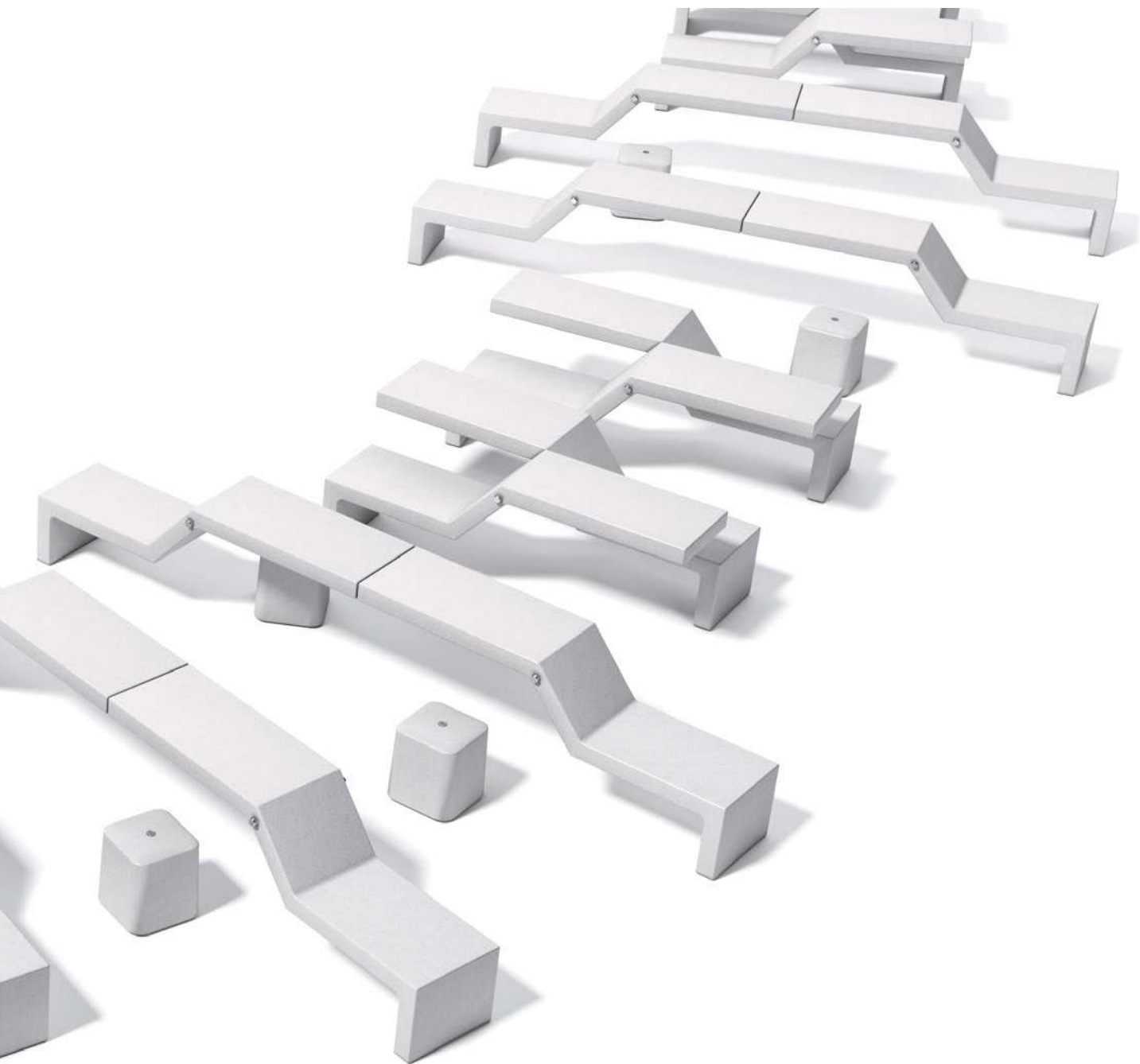





## TWIN

Designer:	Massimo Tasca
Dimensions and weight Dimensiones y peso:	4240x500 mm H 750 mm h 422 mm 690 kg
	2120x1000 mm H 750 mm h 422 mm 690 kg
Materials/Materiales:	HPC (High Performance Concrete)
Finishes/Acabados:	Velluto - Natural smooth Velluto - Liso natural
Fixing/Fijación:	Installation with threaded bars Cimentación con varillas roscadas

Collection of modular elements made of HPC (High Performance Concrete) with integrated seat and table, available in two versions. The first is composed of two cantilevered structures, crossed to create a system of two seats with front table. The second is composed of two specular cantilevered structures, to create a long table, with seat at the ends. They can be installed individually or in compositions and are compatible with the single seat Mizar S.

Colección de elementos modulares en HPC (High Performance Concrete) con asiento y mesa integrados, disponibles dos versiones. La primera está formada por dos estructuras en voladizo, cruzadas para crear un sistema de dos asientos con mesa frontal. La segunda se compone de dos estructuras en voladizo especulares, para crear una mesa larga con asiento en las extremidades. Pueden ser instaladas individualmente o en composición y son compatibles con el asiento monoplaza Mizar S.

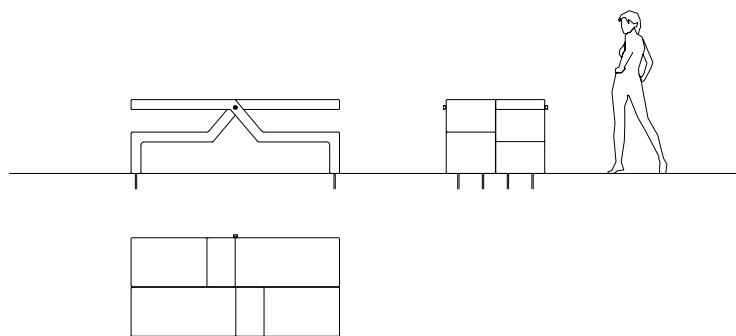



Monolithic single seat in HPC (High Performance Concrete). It can be installed individually or in compositions with the elements of the Isolaurbana collection and the Twin collection.

Asiento monoplaza monolítico en HPC (High Performance Concrete). Puede ser instalado individualmente o en composición con elementos de la colección Isolaurbana y de la colección Twin.

## MIZARS

Designer:	Alfredo Tasca + Raffaele Lazzari
Dimensions and weight Dimensiones y peso:	377x377 mm H 420 mm 126 kg
Materials/Materiales:	HPC (High Performance Concrete)
Finishes/Acabados:	Velluto - Natural smooth Velluto - Liso natural
Fixing/Fijación:	Freestanding Apoyo

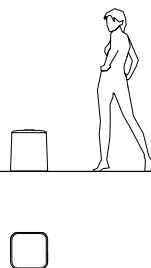





## ULURU COLLECTION

Designer:	<b>Andrea Morgante + Shiro Studio</b>
Dimensions and weight Dimensiones y peso:	<b>2100x700 mm H 740 mm h 430 mm 120 kg</b>
Materials/Materiales:	<b>UHPC (Ultra High Performance Concrete) + Powder coated steel o Powder coated Stainless steel UHPC (Ultra High Performance Concrete) + Acero pintado o Acero Inox pintado</b>
Finishes/Acabados:	<b>UHPC Alfa - Natural smooth UHPC Alfa - Liso natural</b>
Fixing/Fijación:	<b>Freestanding with pedestals or Installation with threaded bars Predisposición para tacos o Cimentación con varillas roscadas</b>

Collection of modular benches, composed of a steel tube frame, equipped with four vertical supports and a seat made of UHPC (Ultra High Performance Concrete). Three modules are available: one without backrest and two, in different lengths, equipped with backrest. They can be installed individually or in compositions.

Colección de bancos modulares, formados por una estructura en tubo de acero, dotado de cuatro soportes verticales y de una superficie que sirve de asiento en UHPC (Ultra High Performance Concrete). Disponibles tres módulos: uno sin respaldo, y dos, con diferentes largos, con respaldo. Pueden ser instalados individualmente o en composición.



## ULURU COLLECTION

Designer:	Andrea Morgante + Shiro Studio
Dimensions and weight Dimensiones y peso:	2100x700 mm H 740 mm h 430 mm 120 kg
Materials/Materiales:	UHPC (Ultra High Performance Concrete) + Powder coated steel o Powder coated Stainless steel UHPC (Ultra High Performance Concrete) + Acero pintado o Acero Inox pintado
Finishes/Acabados:	UHPC Alfa - Natural smooth UHPC Alfa - Liso natural
Fixing/Fijación:	Freestanding with pedestals or Installation with threaded bars Predisposición para tacos o Cimentación con varillas roscadas

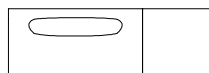
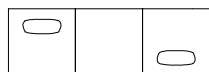
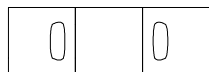
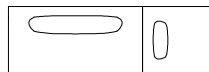
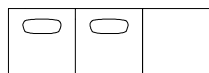
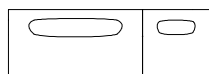
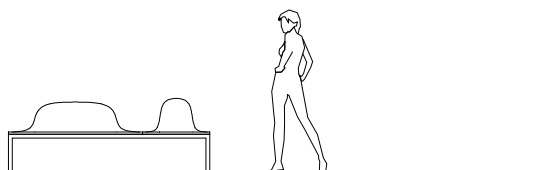



VOLO COLLECTION





1800 S

900 S

1800

900



Collection of modular benches made from the folding of a single laser cut sheet. Four models are available in two different sizes, with or without backrest equipped with stainless steel spacers and armrests in cast aluminum.

Colección de bancos modulares realizados a partir del pliegue de una sola chapa cortada a láser. Disponibles cuatro modelos de dos diferentes tamaños, con o sin respaldo, dotados de distancias en acero Inoxidable y apoyabrazos en fundición de aluminio.

## VOLO COLLECTION

Designer:	Alessandro Lenarda
Dimensions and weight Dimensiones y peso:	<p><b>1800 S</b> 1800x615 mm H 778 mm h 435 mm 217 kg</p> <p><b>900 S</b> 900x615 mm H 778 mm h 435 mm 111 kg</p> <p><b>1800</b> 1800x615 mm H 435 mm 152 kg</p> <p><b>900</b> 900x615 mm H 435 mm 76 kg</p>
Materials/Materiales:	Powder coated steel or Corten steel Acero pintado o Acero Corten
Fixing/Fijación:	Pre-drilled for anchors Predisposición para tacos

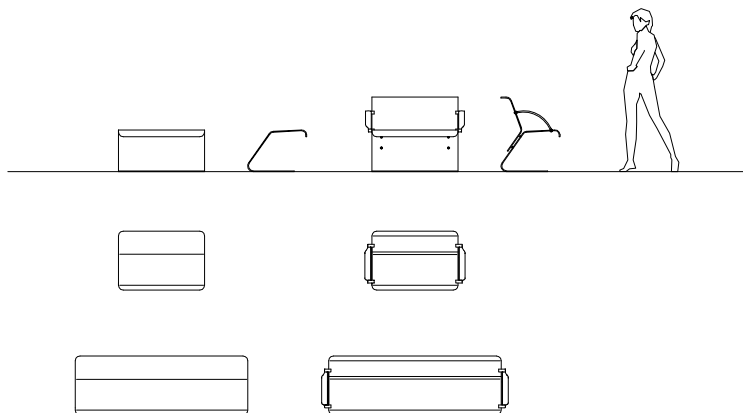



VOLO EVOLUTION

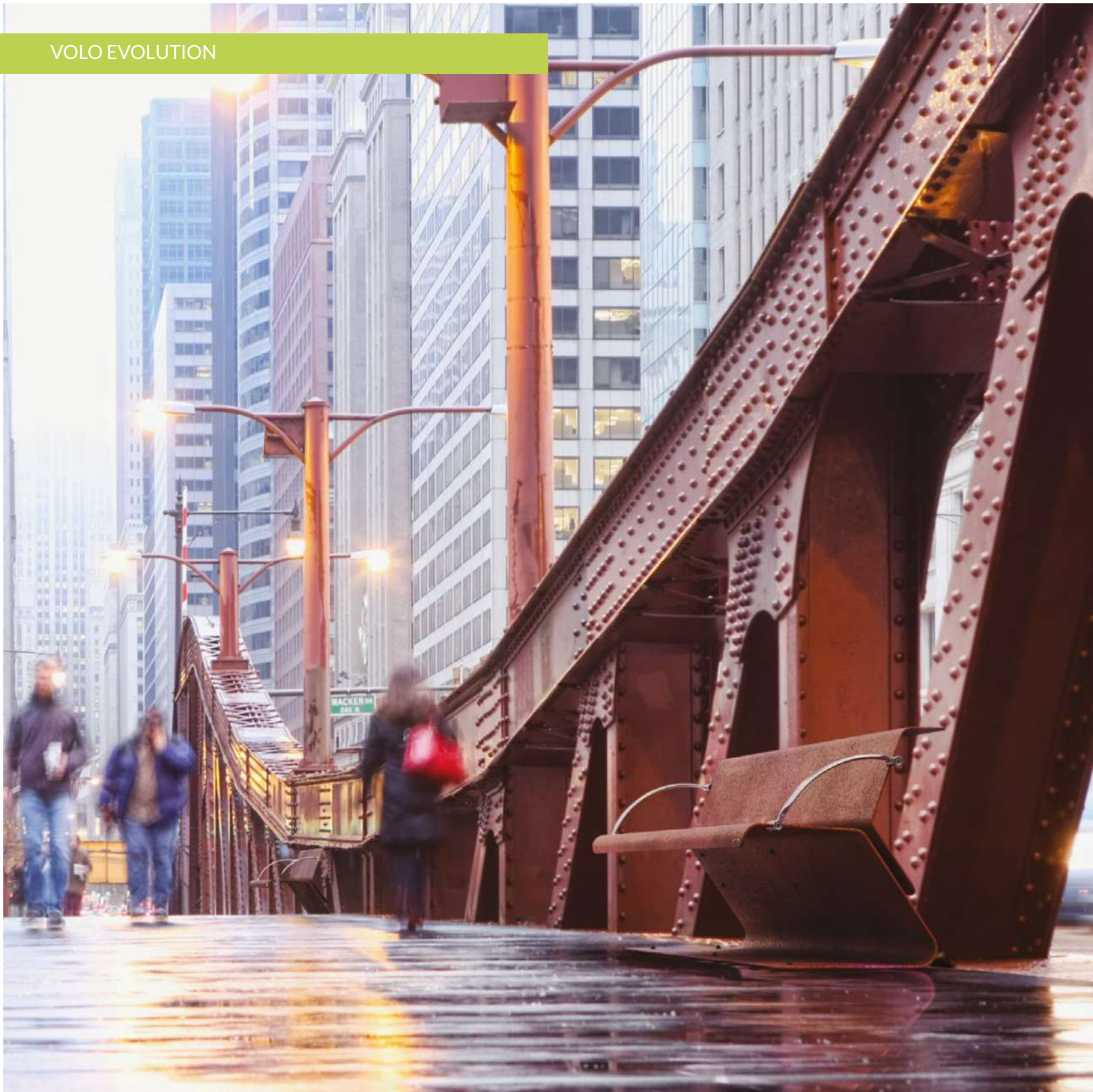



Collection of modular benches with backrest equipped with stainless steel spacers and armrests in cast aluminum, made from the folding of a single laser cut sheet. Two sizes are available. The backrest is equipped with a curvature that makes it usable, on the outside, as a leaning seat.

Colección de bancos modulares con respaldo dotados de distanciales en acero Inoxidable y apoyabrazos en fundición de aluminio, realizadas a partir del pliegue de una sola chapa cortada a láser. Disponibles dos modelos con diferentes tamaños. El respaldo dispone de una curvatura que hace que pueda utilizarse, en el lado externo, como asiento isquiático.

## VOLO EVOLUTION

Designer:	Alessandro Lenarda
Dimensions and weight Dimensiones y peso:	1070x645 mm H 715 mm h 435 mm 108 kg
	1970x645 mm H 715 mm h 435 mm 212 kg
Materials/Materiales:	Powder coated steel or Corten steel Acero pintado o Acero Corten
Fixing/Fijación:	Pre-drilled for anchors Predisposición para tacos

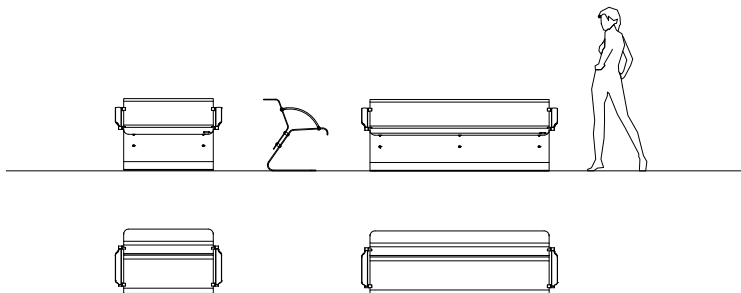



ALFREDO TASCA  
MASSIMO TASCA  
RAFFAELE LAZZARI  
STAUBACH & KUCKERTZ  
ALESSANDRO LENARDA  
SJIT  
MARCO DE LUCA

---



# PICNIC AREA: CONVIVIALITY IS OUTDOOR

Àrea pic nic:  
la convivència es  
al aire libre



AIR - CIRCLE









AIR - CIRCLE



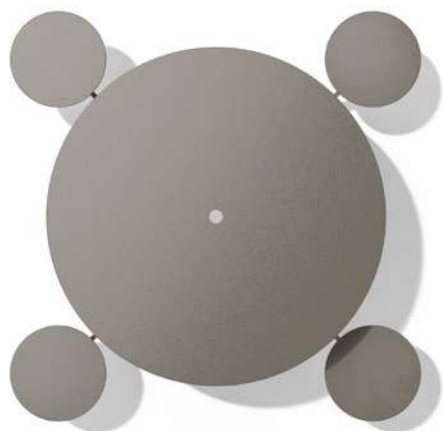

4

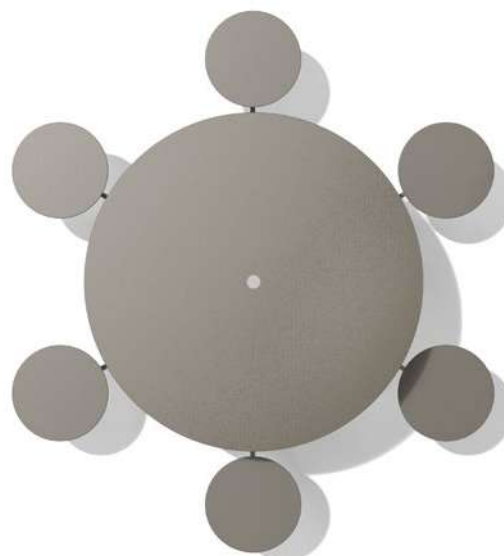

6

Collection of round tables with integrated stools, made of HPL (High Pressure Laminate), composed of a supporting structure in thick steel sheet, with proper tube connections for the seats and the table. Two versions are available: four-seater with two height-adjustable stools and six-seater with three height-adjustable stools.

Colección de mesas redondas con taburetes integrados, realizados en HPL (High Pressure Laminate), constituida de una estructura portante en una gruesa chapa de acero, con las correspondientes juntas en tubo para los asientos y la mesa. Disponibles en dos versiones: de cuatro plazas con dos taburetes regulables en altura y de seis plazas con tres taburetes regulables en altura.

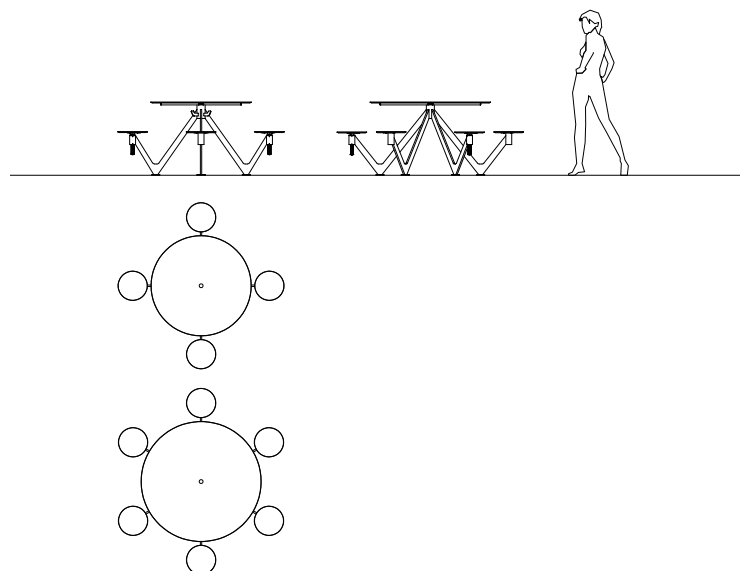

## AIR - CIRCLE

Designer:	Massimo Tasca	
Dimensions and weight Dimensiones y peso:	4	53 kg
	1660x1660 mm	
	6	84 kg
	1860x1860	
	H 730 mm (table - mesa) h 434 mm (seat - asiento)	
Materials/Materiales:	Powder coated steel + HPL (High Pressure Laminate) Acero pintado + HPL (High Pressure Laminate)	
Fixing/Fijación:	Pre-drilled for anchors Predisposición para tacos	



BREAK TIME I







BREAK TIME I









BREAK TIME W

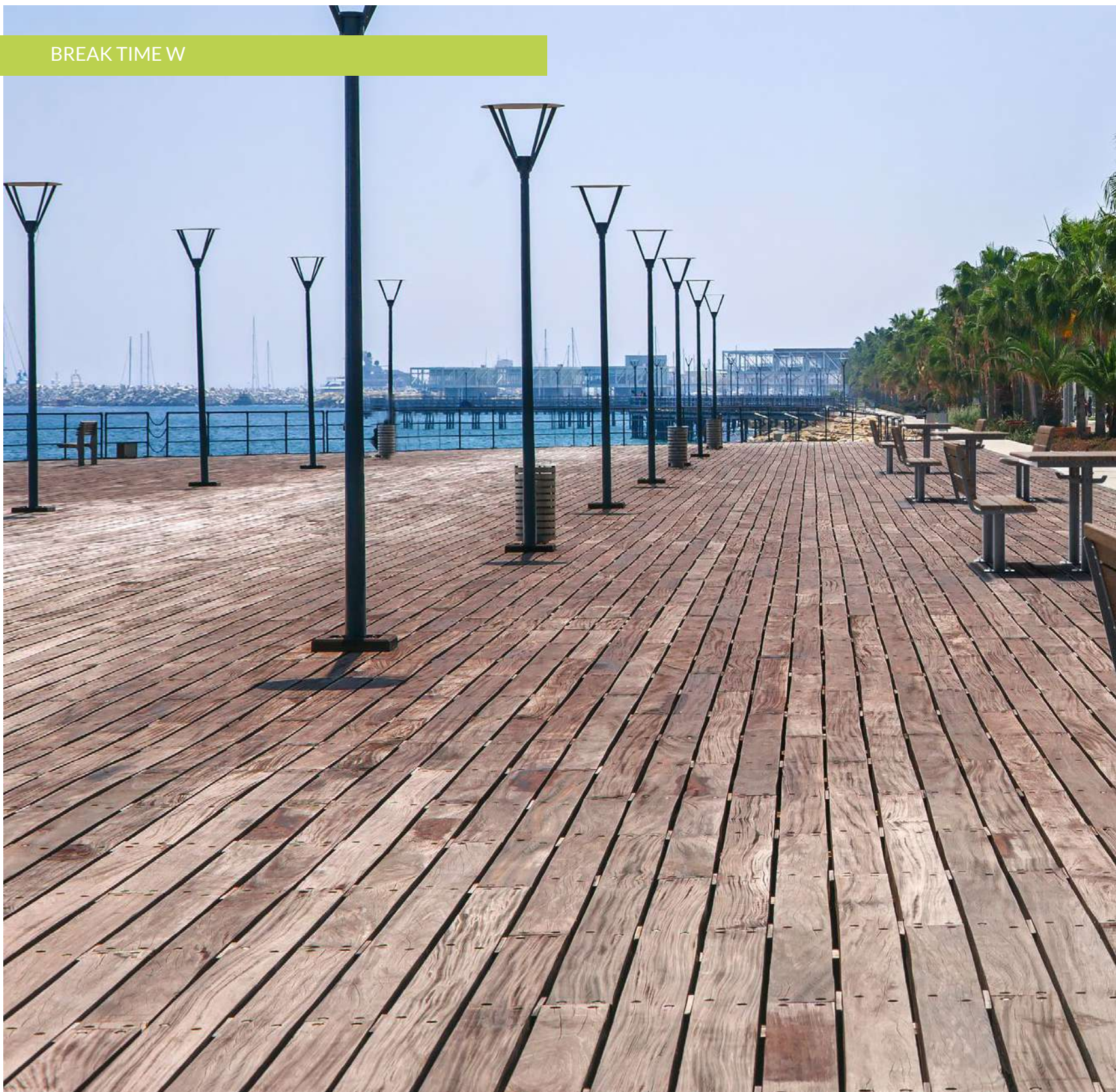











SI7S



SI7



SI4S



SI4



SIL

Collection of seats available in different models. SIL is a bench with backrest composed of a seat in steel rods and two supports in steel tube. The SI7S, SI7, SI4S, SI4 models are single seats, with different heights, with or without backrest, composed of a vertical support in steel tube and a seat in rods. The SI7S, SI7 models are equipped fixed footrest in stainless steel. The SI7S model is rotating with locking system, with backrest and armrests.

Colección de asientos disponibles en diferentes modelos. SIL es un banco con respaldo dotado de superficie que hace de asiento en varillas de acero y de dos soportes en tubo de acero. Los modelos SI7S, SI7, SI4S, SI4 son asientos monoplazas con o sin respaldo, de diferentes alturas, dotados de un soporte vertical en tubo de acero y de una superficie en varillas que sirve como asiento. Las versiones SI7S, SI7 disponen de reposapiés fijo en acero Inoxidable. El modelo SI7S es giratorio con sistema de bloqueo y está dotado de respaldo y apoyabrazos.

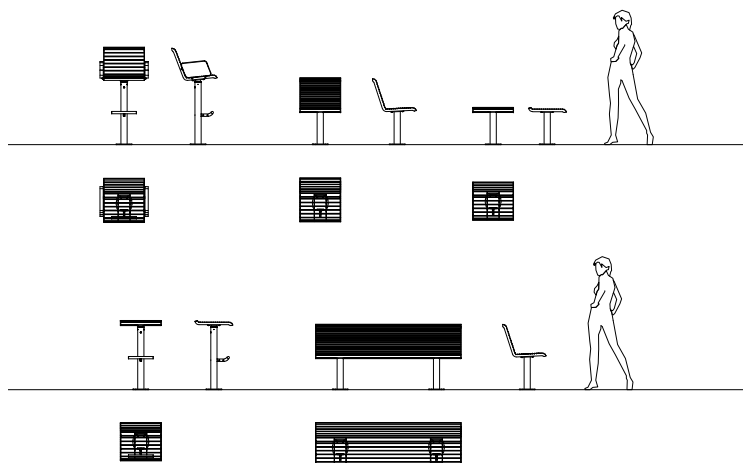

## BREAK TIME I

Designer:	Massimo Tasca
Dimensions and weight Dimensiones y peso:	<p><b>SI7S</b> 590x540 mm H 1180 mm h 850 mm 24 kg</p> <p><b>SI7</b> 500x470 mm H 850 mm 16 kg</p> <p><b>SI4S</b> 500x540 mm H 820 mm h 455 mm 16 kg</p> <p><b>SI4</b> 500x470 mm H 455 mm 13 kg</p> <p><b>SIL</b> 1800x540 mm H 820 mm h 455 mm 48 kg</p>

Materials/Materiales: Powder coated steel  
Acero pintado

Fixing/Fijación: Pre-drilled for anchors or Below ground installation  
Predisposición para tacos o Cimentación



BREAK TIME W





SW7S

SW7

SW4S

SW4

SWL

Collection of seats available in different models. SWL is a bench with backrest composed of a wooden seat and two steel supports. The SW7S, SW7, SW4S, SW4 models are single seats, with different heights, with or without backrest, equipped with a vertical support in steel tube and a wooden seat. The SW7S, SW7 models are equipped with fixed footrest in stainless steel. The SW7S model is rotating with locking system, with backrest and armrests.

Colección de asientos disponibles en diferentes modelos. SWL es un banco con respaldo formado de una superficie para sentarse de madera y dos soportes en acero. Los modelos SW7S, SW7, SW 4S, SW4 son asientos monoplazas con o sin respaldo, dotados de un soporte vertical en tubo de acero y de una superficie para sentarse de madera. Disponibles en dos alturas. Las versiones SW7S, SW7 disponen de apoyapiés fijo en acero Inoxidable. El modelo SW7S es giratorio, con sistema de bloqueo y está dotado de respaldo y apoyabrazos.

## BREAK TIME W

Designer:

Massimo Tasca

Dimensions and weight  
Dimensiones y peso:

**SW7S**  
585x540 mm H 1990 mm h 850 mm  
28 kg

**SW7**  
500x460 mm H 850 mm  
19 kg

**SW4S**  
500x520 mm H 820 mm h 455 mm  
21 kg

**SW4**  
500x460 mm H 455 mm  
16 kg

**SWL**  
1800x520 mm H 820 mm h 455 mm  
58 kg

Materials/Materiales:

Powder coated steel + Hardwood  
Acero pintado + Madera dura

Fixing/Fijación:

Pre-drilled for anchors or Below ground installation  
Predisposición para tacos o Cimentación

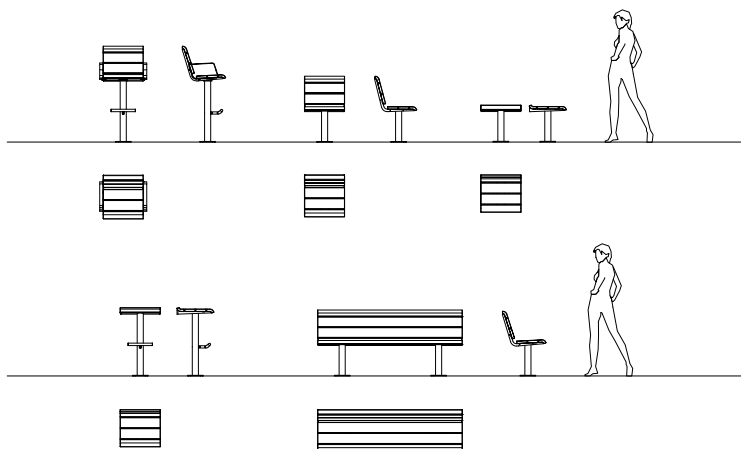



BREAK TIME TI









TIA



TIB



TIL

## BREAK TIME TI

Designer:	Massimo Tasca		
Dimensions and weight Dimensiones y peso:	TIA	800x800 mm H 1205 mm	25 kg
	TIB	800x800 mm H 750 mm	23 kg
	TIL	1800x800 mm H 750 mm	69 kg
Materials/Materiales:	Powder coated steel Acero pintado		
Fixing/Fijación:	Pre-drilled for anchors or Below ground installation Predisposición para tacos o Cimentación		

Collection of tables available in different heights. The steel structure, with plane in rods, rests on tube supports. All tables are equipped with handbag hooks. The supports on the TIL model are positioned to be compatible with wheelchairs.

Colección de mesas disponibles en varias alturas. La estructura, en acero está formada por una superficie con varillas y un soporte en tubo. Todas las mesas están equipadas con ganchos para colgar el bolso. En la versión TIL los soportes se han posicionado para permitir el acceso a una silla de ruedas.

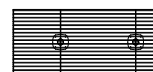
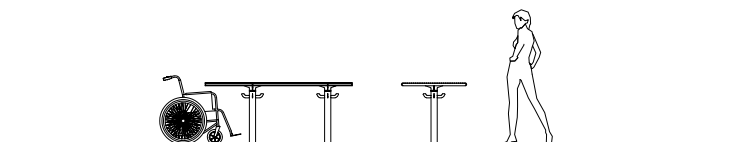
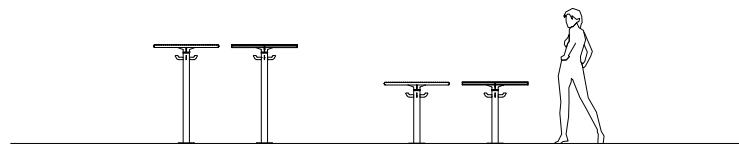



TWA

TWB

TWL

Collection of tables available in different heights. The steel structure, with plane in rods, rests on tube supports. All tables are equipped with handbag hooks. The supports on the TWL model are positioned to be compatible with wheelchairs.

Colección de mesas disponibles en varias alturas. La estructura, en acero está formada por superficie de madera y un soporte en tubo de acero. Todas las mesas están equipadas con ganchos para colgar el bolso. En la versión TWL los soportes se han posicionado para permitir el acceso a una silla de ruedas.

## BREAK TIME TW

Designer:	Massimo Tasca	
Dimensions and weight Dimensiones y peso:	TWA 810x810 mm H 1205 mm	25 kg
	TWB 810x800 mm H 750 mm	32 kg
	TWL 1800x810 mm H 750 mm	66 kg
Materials/Materiales:	Powder coated steel + Hardwood Acero pintado + Madera dura	
Fixing/Fijación:	Pre-drilled for anchors or Below ground installation Predisposición para tacos o Cimentación	

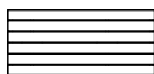
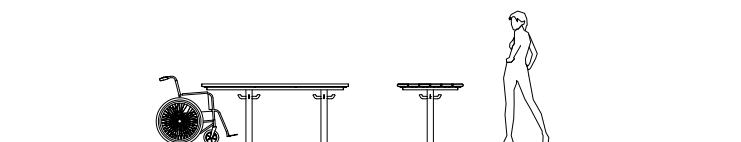
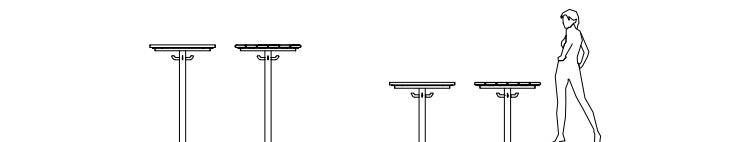



AIR - A

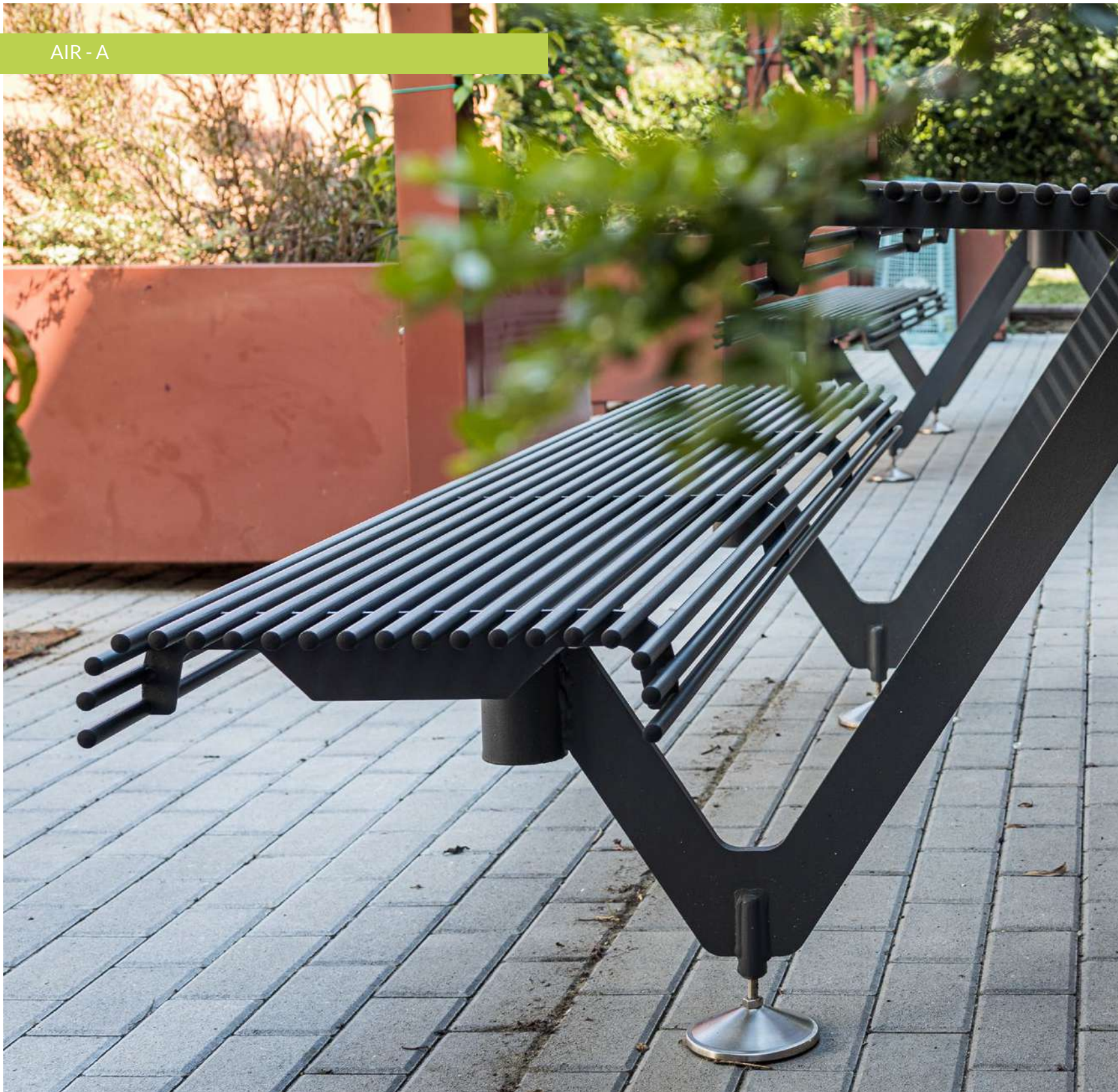







AIR - A

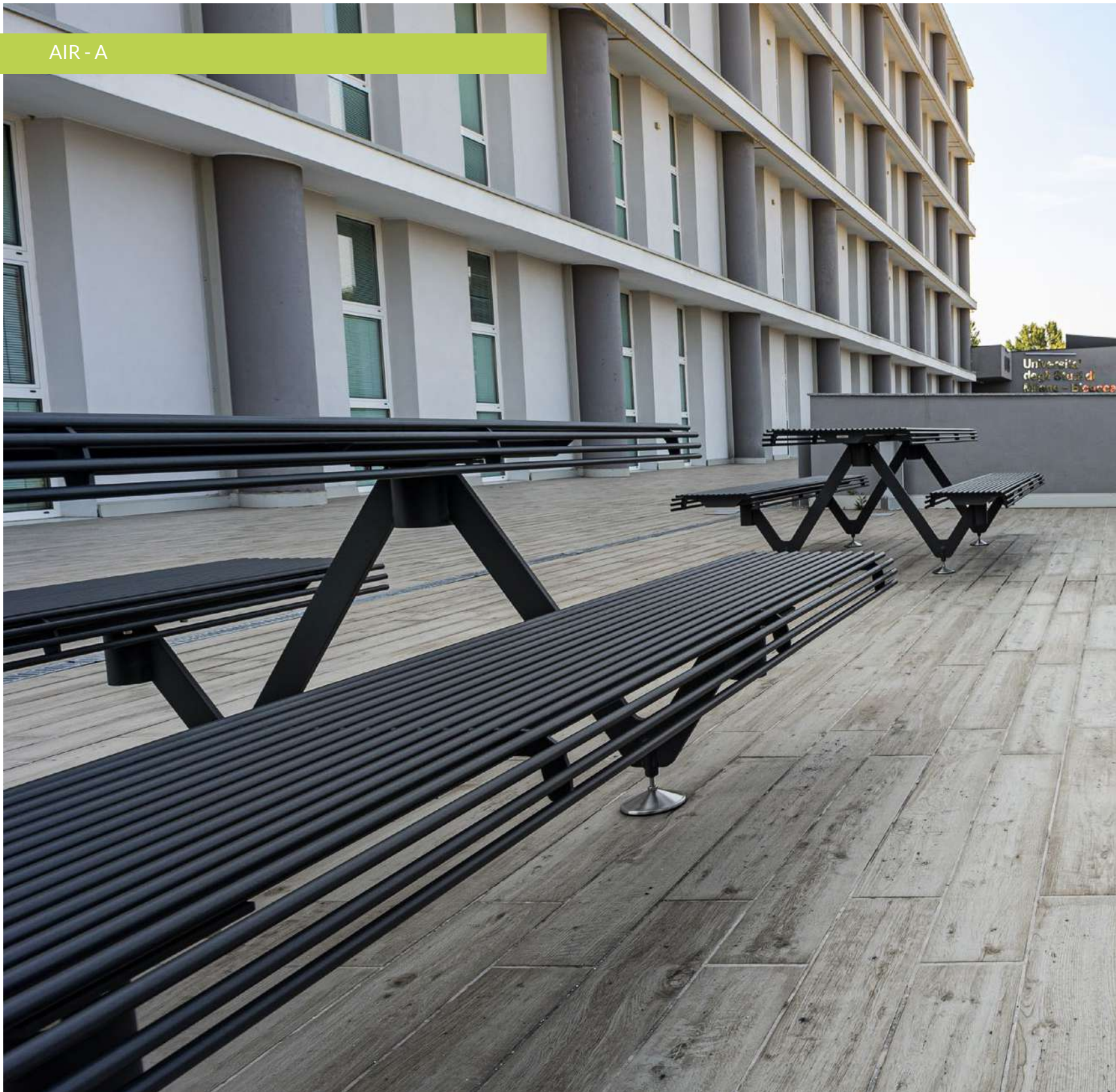



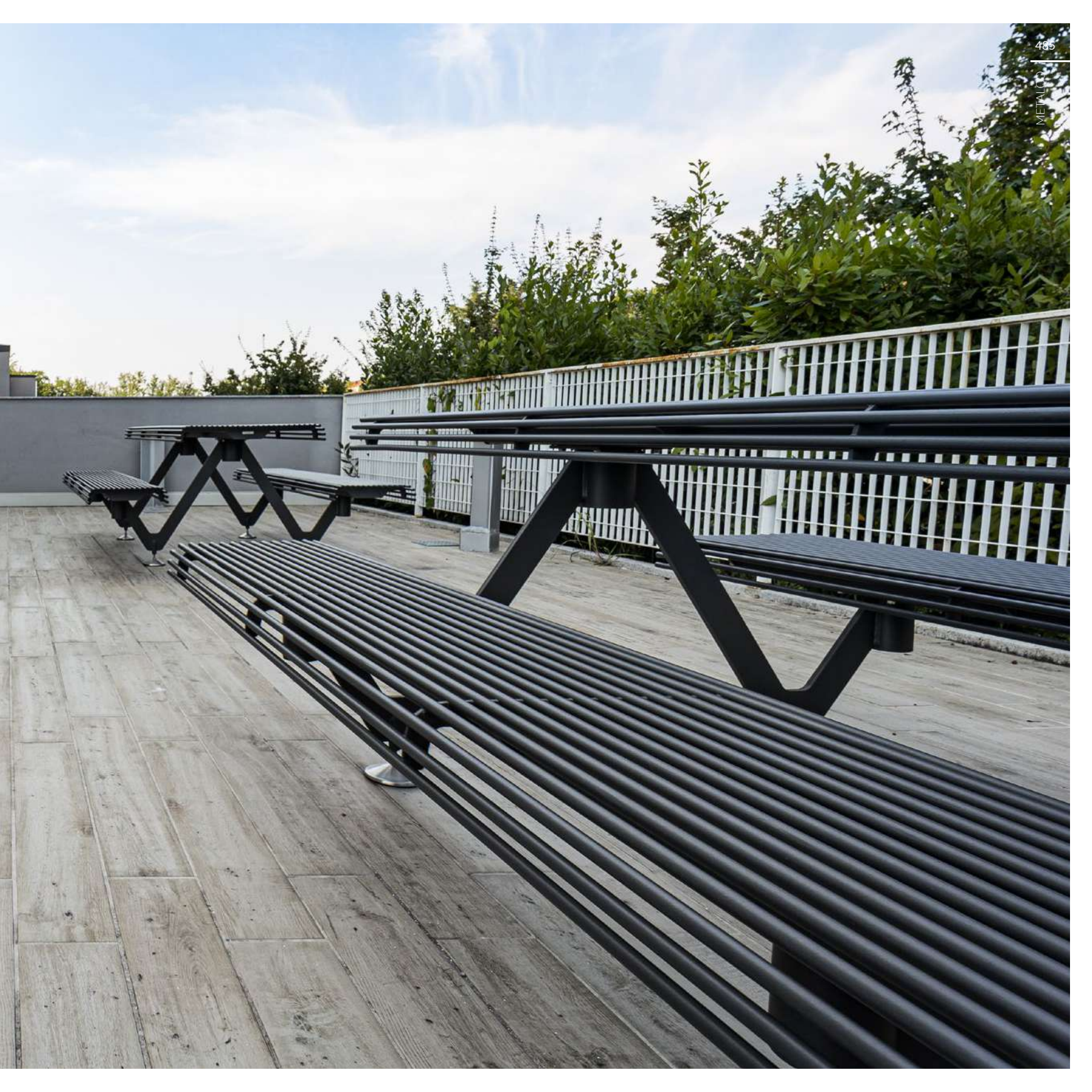





## AIR - A

Designer:	<b>Alfredo Tasca + Massimo Tasca + Raffaele Lazzari</b>
Dimensions and weight Dimensiones y peso:	<b>2200x1700 mm H 744 mm h 424 mm 178 kg</b>
Materials/Materiales:	<b>Powder coated steel Acero pintado</b>
Fixing/Fijación:	<b>Freestanding with pedestals or Installation with threaded bars Apoyo con pies o Cimentación con varillas roscadas</b>
Accessories/Accesorios:	<b>Anti-theft screws Tornillos antirrobo</b>

Modular steel table with two integrated seats and composed of a supporting structure made of thick steel sheet and a plane in tubes.

Mesa modular con dos asientos integrados, realizados en acero y constituidos de una estructura portante en gruesa chapa de acero y de una base en tubos.

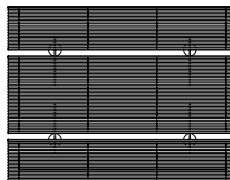
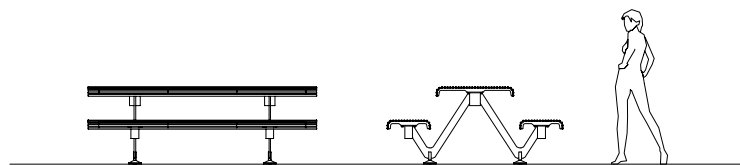



Modular steel table with integrated seats and composed of a thick steel sheet supporting structure, a plane and two wooden seats.

Mesa modular con asientos integrados, realizada en acero y constituida de una estructura portante en gruesa chapa de acero, de una base de apoyo y de dos asientos de madera.

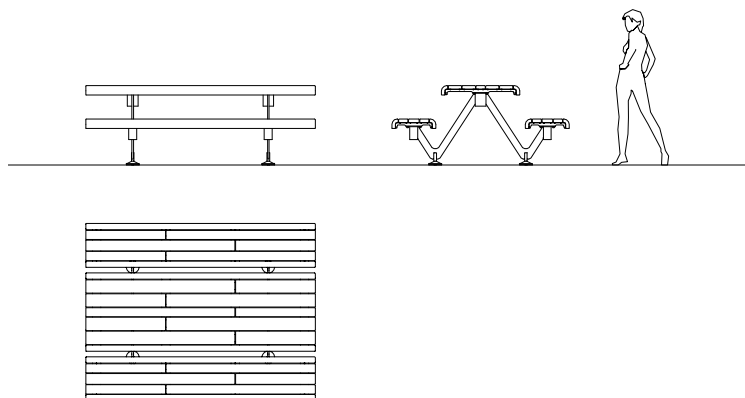

## AIR - L

Designer:	Alfredo Tasca + Massimo Tasca + Raffaele Lazzari
Dimensions and weight Dimensiones y peso:	2200x1700 mm H 760 mm h 440 mm Hardwood   Madera dura 222 kg Larch   Alerce 190 kg
Materials/Materiales:	Powder coated steel + Hardwood or Larch Acero pintado + Madera dura o Alerce
Fixing/Fijación:	Freestanding with pedestals or Installation with threaded bars Apoyo con pies o Cimentación con varillas roscadas
Accessories/Accesorios:	Anti-theft screws Tornillos antirrobo



AIR - CS

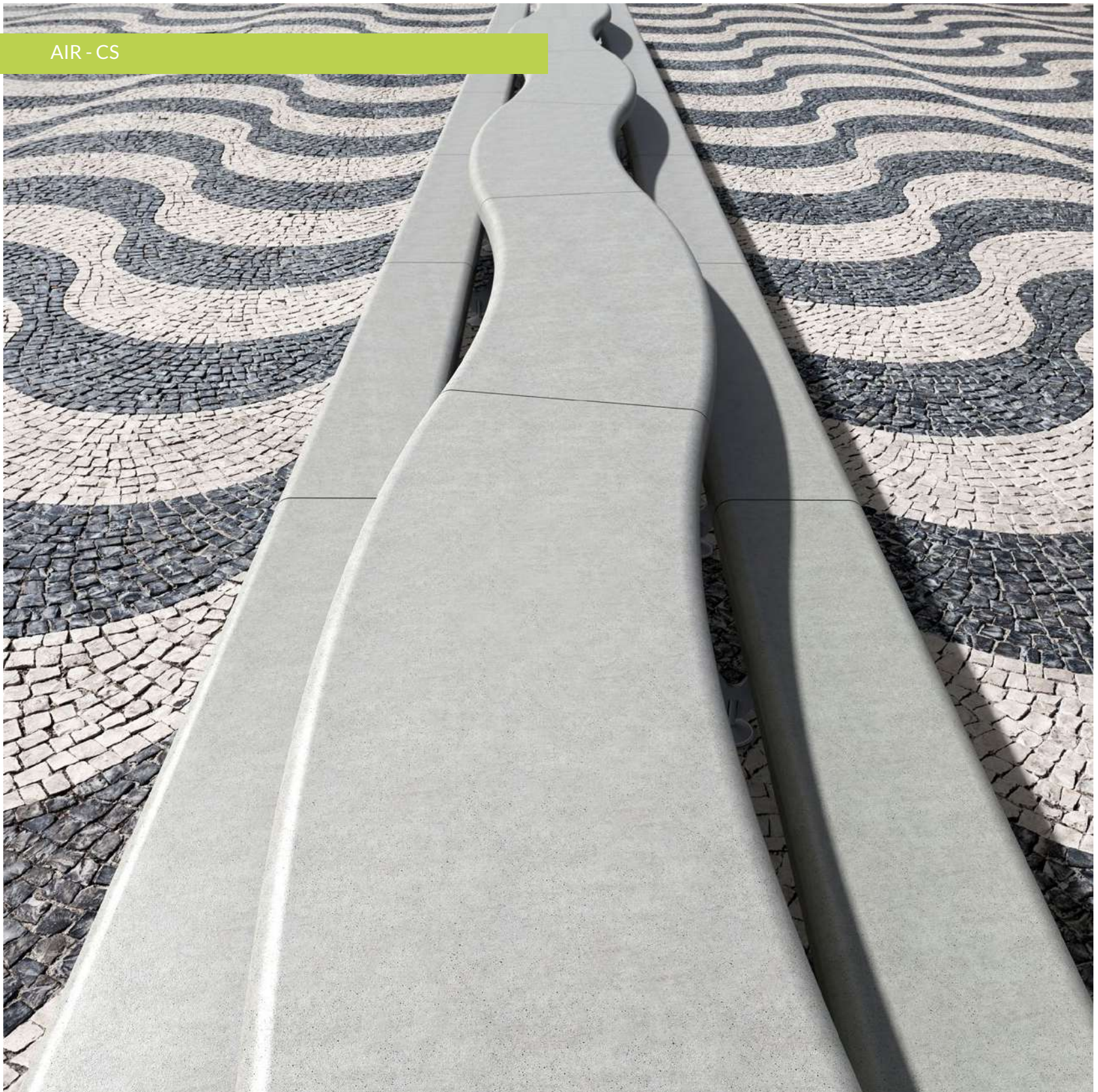





Collection of modular tables with integrated seats, made of UHPC (Ultra High Performance Concrete), composed of thick metal sheet supports, a plane and two seats in UHPC (Ultra High Performance Concrete). Two versions, linear or curved, are available.

Colección de mesas modulares con asientos integrados, realizados en UHPC (Ultra High Performance Concrete), constituidos de soportes gruesos en chapa de acero, de una base de apoyo y de dos asientos en UHPC (Ultra High Performance Concrete). Disponible en versión lineal o curva.

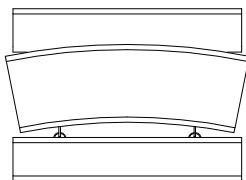
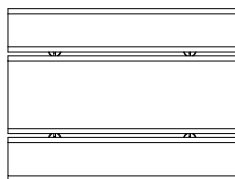
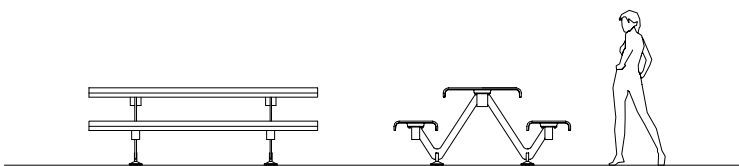

## AIR - C | AIR - CS

Designer:	Alfredo Tasca + Massimo Tasca + Raffaele Lazzari
Dimensions and weight Dimensiones y peso:	2200x1660 mm H 744 mm h 424 mm 252 kg
Materials/Materiales:	UHPC (Ultra High Performance Concrete) + Powder coated steel UHPC (Ultra High Performance Concrete) + Acero pintado
Finishes/Acabados:	UHPC Alfa - Natural smooth UHPC Alfa - Liso natural
Fixing/Fijación:	Freestanding with pedestals or Installation with threaded bars Apoyo con pies o Cimentación con varillas roscadas
Accessories/Accesorios::	Anti-theft screws Tornillos antirrobo





## B - B SASS

Designer:	Stauck & Kuckertz	
Dimensions and weight Dimensiones y peso:	Ø 653 mm H 813 mm	56   82 kg
Materials/Materiales:	Galvanized steel + Corten steel + Stainless steel Acero galvanizado + Acero Corten + Acero Inox	
Fixing/Fijación:	Freestanding Apoyo	

Collection of steel barbecue composed of a supporting structure in electrowelded mesh with sheet metal bottom, equipped with integrated brazier in Corten steel sheet and stainless steel grid with anti-theft chain. The supporting structure has to be filled with inert material not provided and chosen by the customer. The barbecue is available with a simple brazier or with a lower compartment for wood storage.

Colección de barbacoas en acero formadas por una estructura portante en malla electrosoldada con fondo de chapa, equipada con brasero integrado en chapa de acero Corten y parrilla en acero Inoxidable con cadena antirrobo. La estructura de soporte debe rellenarse con material inerte no suministrado y elegido por el cliente. La barbacoa está disponible con un brasero simple o con un compartimento inferior

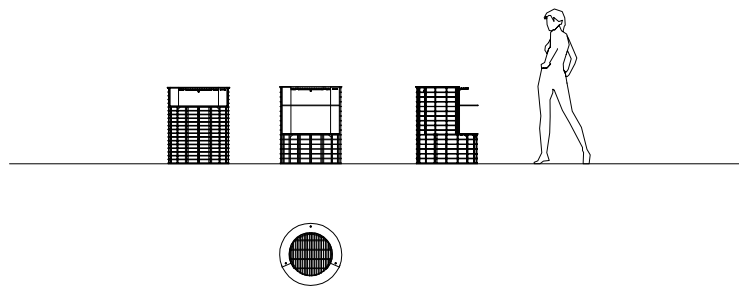



Barbecue made of Corten steel composed of a rotating top equipped with refractory plate and a stainless steel anti-theft grid, adjustable in three heights. The structure stands on a central support.

Barbacoa en acero Corten formada por una superficie giratoria equipada con una placa refractaria y una parrilla antirrobo de acero Inoxidable, regulable en tres alturas. La estructura se apoya sobre un soporte central.

## B - BQ

Designer:	Massimo Tasca
Dimensions and weight Dimensiones y peso:	1030x740 mm H 990 mm 129 kg
Materials/Materiales:	Corten steel + Stainless steel Acero Corten + Acero Inox
Fixing/Fijación:	Below ground installation Cimentación

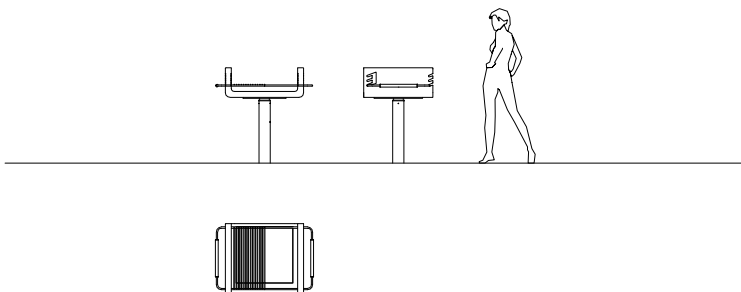





## C - BQ

Designer:	Massimo Tasca
Dimensions and weight Dimensiones y peso:	1050x800 mm H 1060 mm 166 kg
Materials/Materiales:	Corten steel + Stainless steel Acero Corten + Acero Inox
Fixing/Fijación:	Below ground installation Cimentación

Barbecue made of Corten steel composed of a rotating top equipped with refractory plate and a stainless steel anti-theft grid, adjustable in three heights. The structure stands on an "L" support.

Barbacoa en acero Corten formada por una superficie equipada con una placa refractaria y una parrilla antirrobo de acero Inoxidable, regulable en tres alturas. La estructura se apoya sobre un soporte en "L".

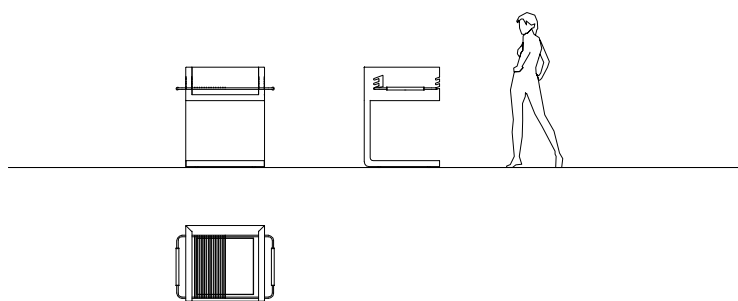



Collection of modular benches, with integrated table, made from the folding of a single laser cut metal sheet. Three sizes are available.

Colección de bancos modulares, con mesa incorporada, realizada del pliegue de una única chapa de acero cortada a láser. Disponible en tres tamaños.

## MERENDA

Designer:	Alessandro Lenarda
Dimensions and weight Dimensiones y peso:	1990x1057 mm H 750 mm h 415 mm 173 kg
	1480x1057 mm H 750 mm h 415 mm 132 kg
	840x1057 mm H 750 mm h 415 mm 79 kg

Materials/Materiales: Powder coated steel or Corten steel  
Acero pintado o Acero Corten

Fixing/Fijación: Pre-drilled for anchors  
Predisposición para tacos

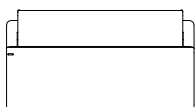
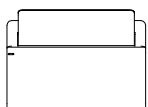
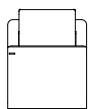
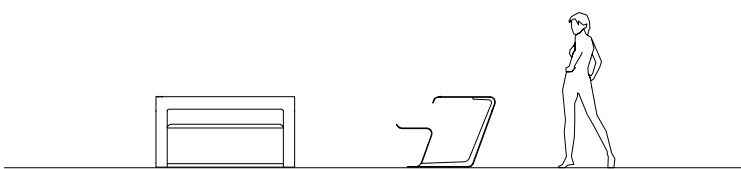





## PIC BULL

Designer:

Sjit

Dimensions and weight  
Dimensiones y peso:

**Seats - Asientos**  
2000x464 mm H 420 mm  
Hardwood | Madera dura 56 kg  
Larch | Alerce 44 kg

**Table - Mesa**  
2000x621 mm H 710 mm  
Hardwood | Madera dura 81 kg  
Larch | Alerce 64 kg

Materials/Materiales:

Powder coated steel or Corten steel +  
Hardwood or Larch  
Acero pintado o Acero Corten + Madera dura  
ou Alerce

Fixing/Fijación:

Pre-drilled for anchors  
Predisposición para tacos

Picnic table with matching seats composed of two supports in steel plate and a wooden top. The benches, without backrest, are composed of two steel plate supports and a wooden seat.

Mesa de picnic con dos bancos a juego, formados por dos soportes en placa de acero y por una superficie de madera. Los bancos, sin respaldo, están compuestos por dos soportes en placa de acero y por un asiento de madera.

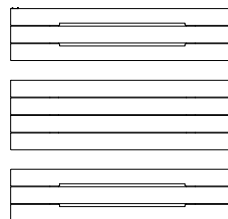
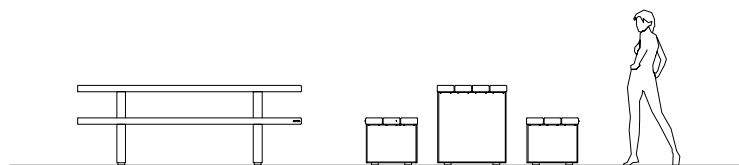



Picnic table with matching seats composed of two laser cut and decorated steel sheet supports and a wooden top. The benches, without backrest, are composed of two supports in laser cut and decorated steel sheet cut and laser decorated and a wooden seat.

Mesa de picnic con dos bancos a juego, formados por dos soportes en chapa de acero cortada y decorada a láser y por una superficie de madera. Los bancos, sin respaldo, están compuestos por dos soportes en chapa de acero cortada y decorada a láser y por un asiento de madera.

## PICNIC

Designer: **Alfredo Tasca + Marco De Luca**

Dimensions and weight  
Dimensiones y peso:

**Seats - Asientos**  
1840x424 mm H 428 mm  
Hardwood | Madera dura 45 kg  
Larch | Alerce 38 kg

**Table - Mesa**  
1840x710 mm H 718 mm  
Hardwood | Madera dura 89 kg  
Larch | Alerce 77 kg

Materials/Materiales:

Powder coated steel + Hardwood or Larch  
Acero pintado + Madera dura o Alerce

Fixing/Fijación:

Pre-drilled for anchors  
Predisposición para tacos

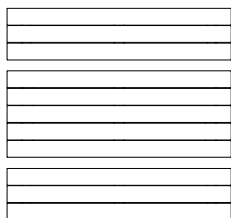
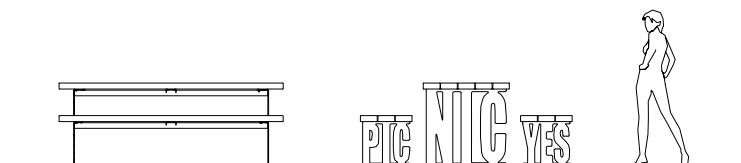



ANTONIO CITTERIO CON TOAN NGUYEN  
ANDREA MORGANTE & SHIRO STUDIO  
INDIO DA COSTA AUDT  
UWE KUCKERTZ  
STAUBACH & KUCKERTZ  
ARCH. FRANCESCO DONATO  
ALFREDO TASCA  
MASSIMO TASCA  
RAFFAELE LAZZARI  
MATTIA LI POMI  
NICCOLÒ BAREA  
ANTONIO AMENDOLA  
ELVIRA CERRATTI  
METALCO DESIGN  
AUREL DESIGN URBAIN  
BETANCOURTDESIGN  
SABRINA TUBIA

---



# LITTER BINS: TO ENCOURAGE VIRTUOUS BEHAVIOURS

Papeleiras:  
para fomentar  
comportamientos  
virtuosos



AERO





A3



A4



AVF

Collection of litter bins composed of a supporting structure with steel coating, equipped with three or four inner liners for separate collection and aluminum lid with holes provided with conveyors in sheet metal. The inner liners are arranged in line. The cover is equipped with two gas struts to assist opening which are activated with the release of the snap lock. Three versions are available, with three or four conveyors for the insertion of waste and one equipped with compartment for fire extinguisher. Composition in line.

Colección de papeleras para la recogida selectiva compuesta por una estructura portante revestida de acero. Dotada de tres o cuatro contenedores internos para la recogida selectiva de basura y tapa superior en aluminio con orificios provistos de identificador de color en chapa de acero. Los contenedores están dispuestos en línea. Tapa puede abrirse gracias a dos pistones a gas que se accionan a través de una cerradura a presión. Disponible en tres versiones con tres o cuatro bocas para la introducción de la recogida selectiva y de un espacio para un extintor.

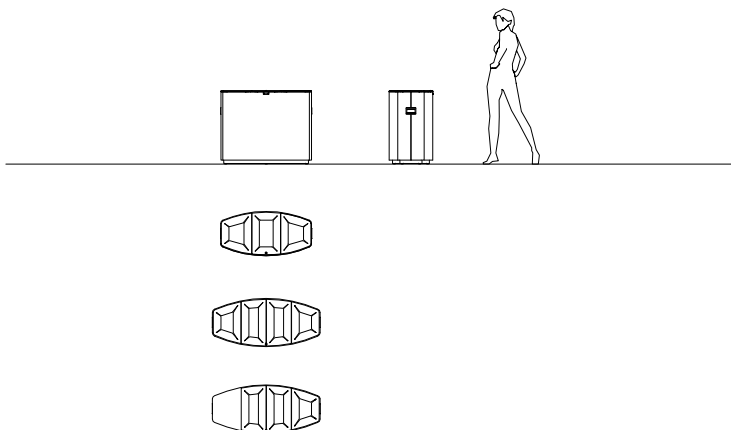

## AERO

Designer:	Alfredo Tasca + Raffaele Lazzari + Antonio Amendola + Elvira Cerratti	
Dimensions and weight Dimensiones y peso:	A3 990x484x800 mm	75 kg
	A4   AVF 1170x525x800 mm	98 kg
Capacity/Capacidad:	A3 2x50, 1x65 lt A4 2x50, 2x60 lt AVF 1x50, 2x60 lt	
Materials/Materiales:	Powder coated steel or Stainless steel + Powder coated aluminum Acero pintado o Acero Inox + Aluminio pintado	
Fixing/Fijación:	Freestanding (indoor only) Apoyo (interiores)	
Accessories/Accesorios:	Custom graphics Gráficas personalizadas	





## AERO Q

Designer:	Niccolò Barea	
Dimensions and weight Dimensiones y peso:	600x600x805 mm	58 kg
Capacity/Capacidad:	4 x 32 lt	
Materials/Materiales:	Powder coated steel or Stainless steel Acero pintado o Acero Inox	
Fixing/Fijación:	Freestanding (indoor only) Apoyo (interiores)	
Accessories/Accesorios:	Custom graphics Gráficas personalizadas	

Litter bin composed of a supporting structure with steel coating, equipped with four inner liners for separate collection and aluminum lid with holes provided with conveyors in sheet metal. The inner liners are arranged in square composition. The cover is equipped with two gas struts to assist opening which are activated with the release of the snap lock.

Papelera compuesta de una estructura portante revestida en acero, dotada de cuatro contenedores internos para la recogida selectiva de basura y tapa superior en aluminio con cuatro orificios con identificador de color en chapa de acero. Los contenedores están posicionados formando un cuadrado. La tapa en aluminio puede abrirse gracias a dos pistones a gas que se accionan a través de una cerradura a presión.

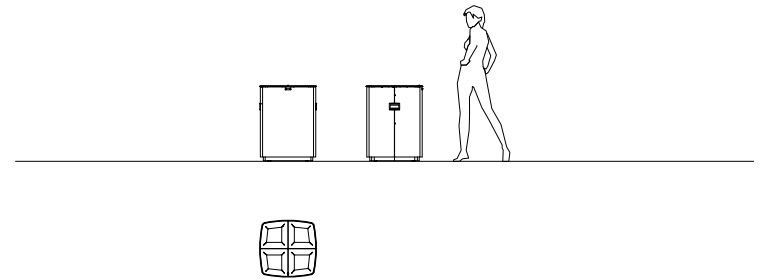



Tulip-shaped litter bin composed of “petals” in shaped steel, with a circular base and an opening lid with central hole, equipped with snap lock. The litter bin is equipped with a bag holder ring.

Papelera en forma de tulipán, compuesta por “pétalos” de acero, con base circular y tapa con un orificio central que se abre con un cierre a presión. Equipada con un aro para la sujeción de bolsas.

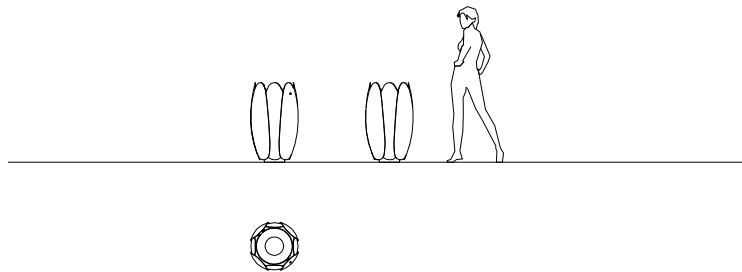

## BLOOM

Designer:	Alfredo Tasca
Dimensions and weight Dimensiones y peso:	Ø 535 mm H 870 mm 48 kg
Capacity/Capacidad:	80 lt
Materials/Materiales:	Powder coated steel Acero pintado
Fixing/Fijación:	Pre-drilled for anchors Predisposición para tacos
Accessories/Accesorios:	Ashtray Cenicero  Inner liner 60 lt Contenedor interno 60 lt  Stainless steel base (indoor) Zócalo en Inox para apoyo (pour intérieur)





## BOTTE

Designer:	Mattia Li Pomi	
Dimensions and weight Dimensiones y peso:	Ø 678 mm H 920 mm	400 kg
Capacity/Capacidad:	85 lt	
Materials/Materiales:	HPC (High Performance Concrete) + Stainless steel HPC (High Performance Concrete) + Acero Inox	
Finishes/Acabados:	HPC Velluto - Natural smooth HPC Velluto - Liso natural	
Accessories/Accesorios:	Pre-drilled for anchors Predisposición para tacos	

Litter bin made of HPC (High Performance Concrete) equipped with opening lid in stainless steel with central hole and lock. It is also equipped with bag holder ring along the inner circumference.

Papelera realizada en HPC (High Performance Concrete) dotada de tapa con un orificio central en acero Inoxidable, que se abre con cerradura y equipado con un aro para la sujeción de bolsas a lo largo de la circunferencia interna.

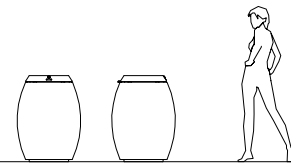



Litter bin made of HPC (High Performance Concrete) with Stainless steel opening lid with central hole and lock and equipped with a bag holder ring along the internal circumference.

Papelera realizada en HPC (High Performance Concrete), dotada de tapa con orificio central en acero Inoxidable, que se abre con cerradura y equipado de un aro para la sujeción de bolsas a lo largo de toda la circunferencia interna.

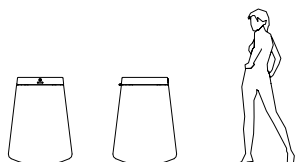

## GAVITELLO

Designer:	Raffale Lazzari	
Dimensions and weight Dimensiones y peso:	Ø 678 mm H 928 mm	340 kg
Capacity/Capacidad:	85 lt	
Materials/Materiales:	HPC (High Performance Concrete) + Stainless steel HPC (High Performance Concrete) + Acero Inox	
Finishes/Acabados:	HPC Velluto - Natural smooth HPC Velluto - Liso natural	
Accessories/Accesorios:	Pre-drilled for anchors Predisposición para tacos	



BOX WOOD







55 Lt

110 Lt

150 Lt

Collection of rectangular litter bins composed of a thick steel sheet supporting structure and two specular panels of which one is fixed and one which opens. Both panels are made of steel tubes covered with vertical slats in Ipe wood. The structure is equipped with a snap lock with steel blade. The litter bin is equipped with bag holder ring and rain cover. Three sizes are available.

Colección de papeleras con forma rectangular compuestas de una estructura portante realizada con una gruesa chapa de acero y dos paneles especulares, uno fijo y otro abatible, que hace las veces de puerta, ambos realizados en tubo de acero revestido con listones verticales de madera de Ipe. La estructura está equipada con un cierre a presión con hoja de acero. La papelera está equipada con un aro para la sujeción de bolsas y una cobertura para la lluvia. Disponible en tres tamaños.

## BOX WOOD

Designer:	Staubach & Kuckertz	
Dimensions and weight Dimensiones y peso:	393x255x780 mm	37 kg
	393x400x1005 mm	68 kg
	517x400x1005 mm	75 kg
Capacity/Capacidad:	55 Lt 110 Lt 150 Lt	
Materials/Materiales:	Powder coated steel + Ipe wood o Powder coated steel Acero pintado + Madera de Ipe o Acero pintado	
Fixing/Fijación:	Pre-drilled for anchors Predisposición para tacos  On the wall A la pared	
Accessories/Accesorios:	Ashtray Fuma Cenicero Fuma	

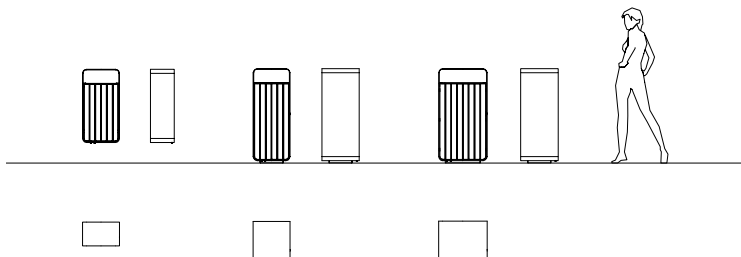





50 Lt



110 Lt



150 Lt

## BOX IRON

Designer:	Staubach & Kuckertz	
Dimensions and weight Dimensiones y peso:	393x255x780 mm	29 kg
	393x400x1005 mm	70 kg
	517x400x1005 mm	78 kg
Capacity/Capacidad:	55 Lt 110 Lt 150 Lt	
Materials/Materiales:	Powder coated steel Acero pintado	
Fixing/Fijación:	Pre-drilled for anchors Predisposición para tacos	
	On the wall A la pared	
Accessories/Accesorios:	Ashtray Fuma Cenicero Fuma	

Collection of rectangular litter bins composed of a thick steel sheet supporting structure and two specular panels of which one is fixed and one which opens. Both panels are made of steel sheet decorated with circular holes. The structure is equipped with a snap lock with steel blade. The litter bin is equipped with bag holder ring and rain cover. Three sizes are available.

Colección de papeleras con forma rectangular compuestas de una estructura portante realizada con una gruesa chapa de acero y dos paneles especulares, uno fijo y otro abatible, que hace las veces de puerta, ambos realizados en chapa de acero decorada con agujeros. La estructura está equipada con un cierre a presión con hoja de acero. La papeleras está equipada con un aro para la sujeción de bolsas y una cobertura para la lluvia. Disponible en tres tamaños.

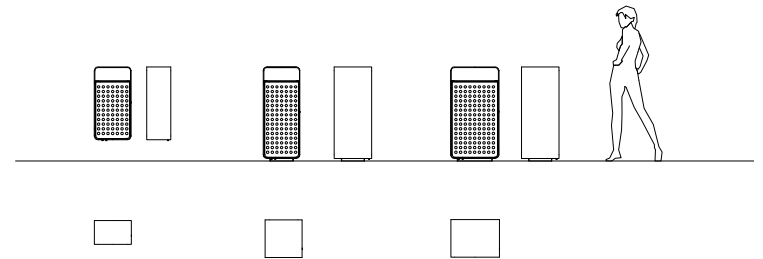



50 lt



110 lt



150 lt

Collection of rectangular litter bins composed of a thick steel sheet supporting structure and two specular panels of which one is fixed and one which opens. Both panels are made of vertical steel rods. The structure is equipped with a snap lock with steel blade. The litter bin is equipped with bag holder ring and rain cover. Three sizes are available.

Colección de papeleras con forma rectangular compuestas de una estructura portante realizada con una gruesa chapa de acero y dos paneles especulares, uno fijo y otro abatible, que hace las veces de puerta, ambos realizadas con varillas verticales en acero. La estructura está equipada con un cierre a presión con hoja de acero. La papelera está equipada con un aro para la sujeción de bolsas y una cobertura para la lluvia. Disponible en tres tamaños.

## BOX LINE

Designer:	Staubach & Kuckertz	
Dimensions and weight Dimensiones y peso:	393x255x780 mm	30 kg
	393x400x1005 mm	72 kg
	517x400x1005 mm	85 kg

Capacity/Capacidad:	55 lt 110 lt 150 lt
---------------------	---------------------------

Materials/Materiales:	Powder coated steel Acero pintado
-----------------------	--------------------------------------

Fixing/Fijación:	Pre-drilled for anchors Predisposición para tacos
------------------	--

	On the wall A la pared
--	---------------------------

Accessories/Accesorios:	Ashtray Fuma Cenicero Fuma
-------------------------	-------------------------------

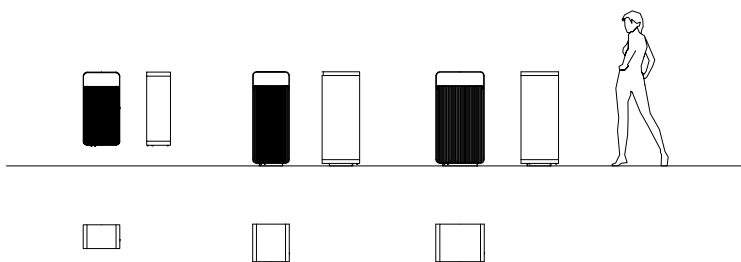



BOX SOLID





50 lt



100 lt



135 lt

Collection of rectangular litter bins composed of a thick steel sheet supporting structure and two specular panels of which one is fixed and one which opens. The latter is equipped with snap lock. The litter bin is equipped with bag holder ring and rain cover. Available in three sizes. The litter bins can be placed side by side to create islands for separate collection.

Colección de papeleras con forma rectangular compuestas de una estructura portante realizada con una gruesa chapa de acero y dos paneles especulares, uno fijo y otro abatible, que hace las veces de puerta dotada de cerradura a presión. La papelera está equipada con un aro para la sujeción de bolsas y una cobertura para la lluvia. Disponible en tres tamaños. Las papeleras pueden ponerse uno al lado del otro para crear islas para la recogida selectiva de basura.

## BOX SOLID

Designer:	Staubach & Kuckertz	
Dimensions and weight Dimensiones y peso:	393x255x780 mm	37 kg
	393x400x1005 mm	60 kg
	517x400x1005 mm	70 kg

Capacity/Capacidad:	50 lt 100 lt 135 lt
---------------------	---------------------------

Materials/Materiales:	Powder coated steel Acero pintado
-----------------------	--------------------------------------

Fixing/Fijación:	Pre-drilled for anchors Predisposición para tacos
------------------	--

	On the wall A la pared
--	---------------------------

Accessories/Accesorios:	Ashtray Fuma Cenicero Fuma
-------------------------	-------------------------------

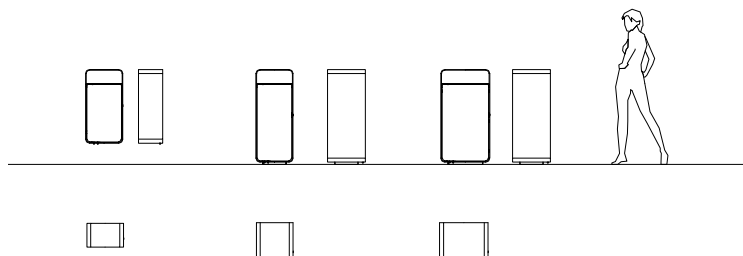



BRAVO COLLECTION





SLICK | STAINLESS STEEL  
SLICK | ACERO INOX



SLICK | POWDER COATED STEEL  
SLICK | ACERO PINTADO



HOLE

Collection of cylindrical litter bins with perforated steel sheet structure and bag holder ring with snap lock. Three models are available: one with a bracket for wall fixing, one prepared for pre-existing pole fixing, one equipped with pole. The latter is available with one, two or three baskets, to create islands for separate collection.

Colección de papeleras de forma cilíndrica con estructura en chapa de acero, en dos acabados, liso o perforado, con aro para la sujeción de bolsas y con cierre a presión. Disponible en tres modelos: uno dotado con soporte para su fijación a muro, otro predispuesto para la fijación a un poste ya existente, uno dotado con el poste. El modelo con el poste puede albergar de uno, dos o tres contenedores, creando islas para la recogida selectiva de basura.

## BRAVO SLICK & HOLE

Designer:	Metalco Design
Dimensions and weight Dimensiones y peso:	330x479x958 mm (+170 mm) 11 kg
Capacity/Capacidad:	35 lt
Materials/Materiales:	Powder coated steel or Stainless steel Acero pintado o Acero Inox
Fixing/Fijación:	Pre-drilled for anchors or Below ground installation or Wall fixing Predisposición para tacos o Cimentación o Fijación a poste existente
Accessories/Accesorios:	Custom graphics Gráficas personalizadas

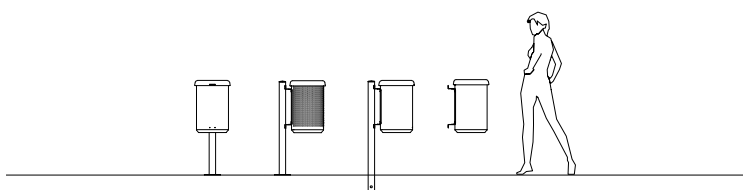





## BRAVO BOOM

Designer:	Mattia Li Pomi
Dimensions and weight Dimensiones y peso:	330x490 H 1140 mm h 968 mm (+ 200 mm*) 9 kg
	330x830 H 1140 mm h 968 mm (+ 200 mm*) 11 kg
	762x705 H 1140 mm h 968 mm (+ 200 mm*) 13 kg
	830x830 mm H 1140 mm h 968 mm (+ 200 mm*) 15 kg
Capacity/Capacidad:	35 lt
Materials/Materiales:	Powder coated steel Acero pintado
Fixing/Fijación:	Pre-drilled for anchors or Below ground installation Predisposición para tacos o Cimentación
Accessories/Accesorios:	Custom graphics Gráficas personalizadas
	Four-leaf shaped plate Placa con forma de trébol de cuatro hojas

Collection of cylindrical litter bins with perforated steel sheet structure and bag holder ring ring with snap lock. Three models are available: one with a bracket for wall fixing, one prepared for pre-existing pole fixing, one equipped with pole. The latter is available with one, two, three or four baskets, to create islands for separate collection. It can also be equipped with rain cover.

Colección de papeleras de forma cilíndrica con estructura en chapa de acero perforada, con aro para la sujeción de bolsas y con cierre a presión. Disponible en tres modelos: uno dotado con soporte para su fijación a muro, otro predispuesto para la fijación a un poste ya existente, uno dotado con el poste. El modelo con el poste puede albergar de uno, dos, tres o cuatro contenedores, creando islas para la recogida selectiva de basura y con la posibilidad de una cobertura para la lluvia.

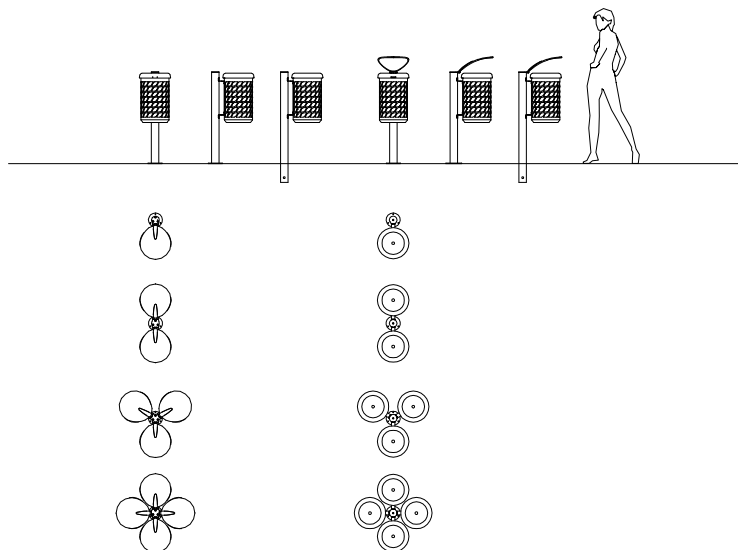



Cylindrical litter bin composed of a structure in laser perforated steel sheet and bag holder ring with snap closure. The litter bin is equipped with steel sheet pole, with cigarette extinguisher plate with integrated container, removable and equipped with lock.

Papelera de forma cilíndrica, con estructura en chapa de acero perforada a láser, con aro para la sujeción de bolsas y cerradura a presión. La papelera está dotada de un poste en chapa de acero y placa para apagar los cigarrillos con contenedor integrado, extraíble y equipado con cerradura.

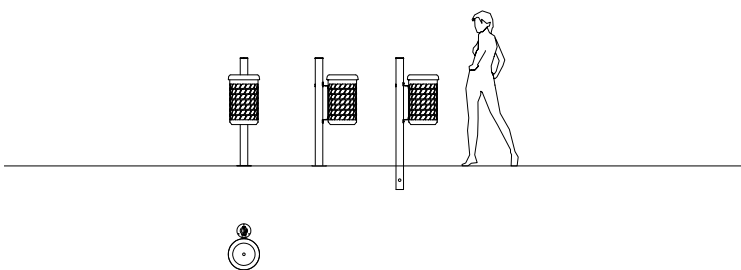

## SUPERBRAVO

Designer:	Massimo Tasca + Mattia Li Pomi
Dimensions and weight Dimensiones y peso:	330x479 H 1148 mm (+ 200 mm) 12 kg
Capacity/Capacidad:	35 lt
Materials/Materiales:	Powder coated steel or Stainless steel Acero pintado o Acero Inox
Fixing/Fijación:	Pre-drilled for anchors or Below ground installation Predisposición para tacos o Cimentación





Collection of litter bins composed of a cylindrical structure and bag holder ring. Different heights are available. The litter bins can be placed side by side to create islands for separate collection.

Colección de papeleras compuesta de una estructura cilíndrica y aro para la sujeción de bolsas. Disponible en diferentes tamaños. Las papeleras pueden posicionarse una al lado de la otra, creando islas, para la recogida selectiva de basuras.

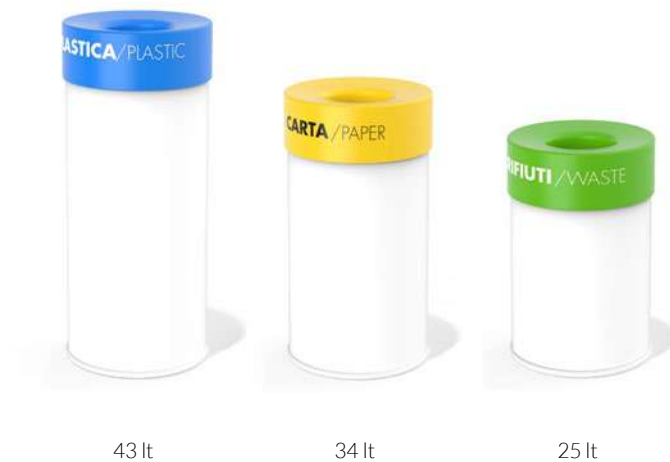
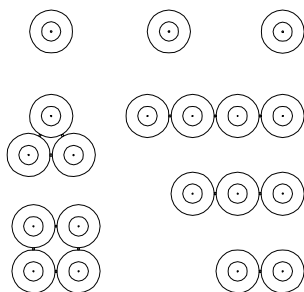
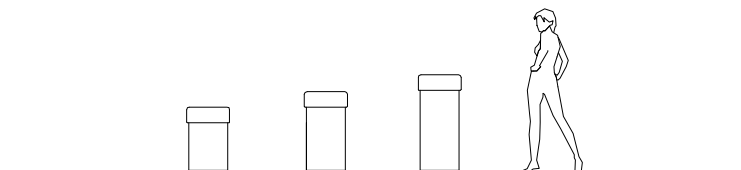

43 lt

34 lt

25 lt

## C3

Designer:	Alfredo Tasca	
Dimensions and weight Dimensiones y peso:	Ø 330 mm H 500 mm	7 kg
	Ø 330 mm H 606 mm	7,5 kg
	Ø 330 mm H 760 mm	8,5 kg
Capacity/Capacidad:	25 lt 34 lt 43 lt	
Materials/Materiales:	Powder coated steel Acero pintado	
Fixing/Fijación:	Freestanding (indoor only) Apoyo (interiores)	
Accessories/Accesorios:	Stainless steel connecting base Base de conexión en Inox  Custom graphics Gráficas personalizadas	

BUND

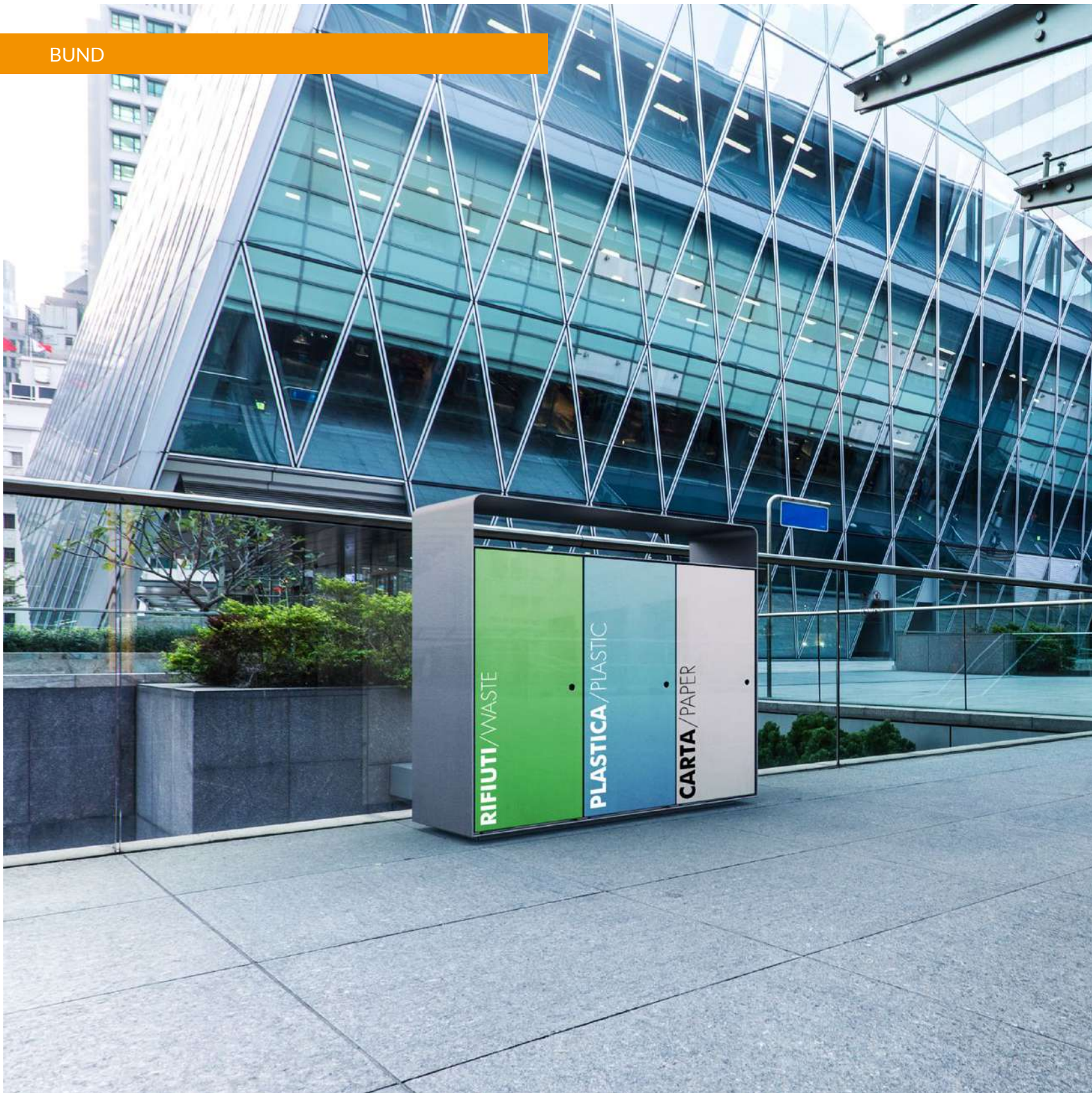





Rectangular litter bin composed of a thick steel sheet supporting structure, closed by steel sheet panel at the rear and by three doors with snap lock at the front. It is equipped with rain cover, three conveyors for the insertion of waste and three bag holder rings for separate collection.

Papelera con forma rectangular compuesto por una estructura portante en chapa gruesa de acero, cerrada en la parte trasera por una chapa de acero y una parte delantera con tres puertas dotadas de cierre a presión. Dotada de cobertura para la lluvia y de tres orificios para la introducción de residuos y de tres aros de sujeción de bolsas para la recogida selectiva de basura.

## BUND

Designer:	Massimo Tasca
Dimensions and weight Dimensiones y peso:	1055x400 mm H 1000 mm <b>111 kg</b>
Capacity/Capacidad:	3x80 lt Bag holder - Soporte para bolsa 3x45 lt Inner liner - Contenedor interno
Materials/Materiales:	Powder coated steel Acero pintado
Fixing/Fijación:	Installation with threaded bars Cimentación con varillas roscadas
Accessories/Accesorios:	Ashtray Fuma Cenicero Fuma  Custom graphics Gráficas personalizadas

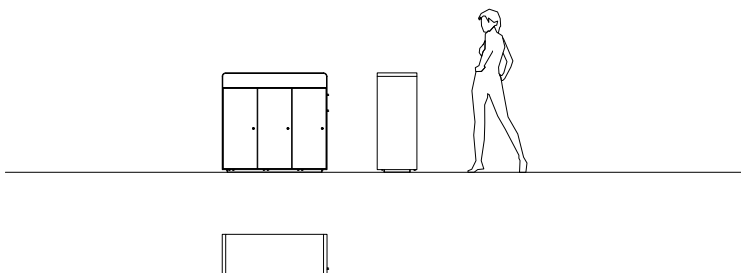



## CESTIS

Designer:	Antonio Citterio con Toan Nguyen
Dimensions and weight Dimensiones y peso:	Ø 334 mm H 950 mm (+ 150 mm) 17 kg
Capacity/Capacidad:	40 lt
Materials/Materiales:	Powder coated aluminum + Powder coated steel Aluminio pintado + Acero pintado
Fixing/Fijación:	Pre-drilled for anchors or Below ground installation Predisposición para tacos o Cimentación
Accessories/Accesorios:	Ashtray Cenicero

Cylindrical litter bin composed of a pole and a cast aluminum lid with a central hole, which can be opened through snap lock. The litter bin is equipped with a liner with bag holder ring.

Papelera con forma cilíndrica, formada por un poste y una cobertura en fundición de aluminio con orificio central, que se abre a través de la cerradura a presión. La papelera está dotada de un contenedor en acero con aro para la sujeción de bolsas.

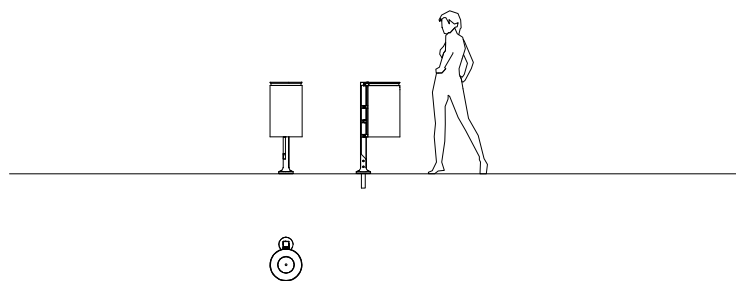





Cylindrical litter bin composed of a steel supporting structure, a perimeter covering made of cast aluminum elements and a steel base. The litter bin is equipped with inner liner and steel lid with central hole, which can be opened through snap lock.

Papelera con forma cilíndrica, compuesta por una estructura portante en acero y un revestimiento perimetral con elementos en fundición de aluminio y de una base de acero. La papelera dispone de un contenedor interno y de una cobertura en acero con orificio central, que se abre con cerradura a presión.

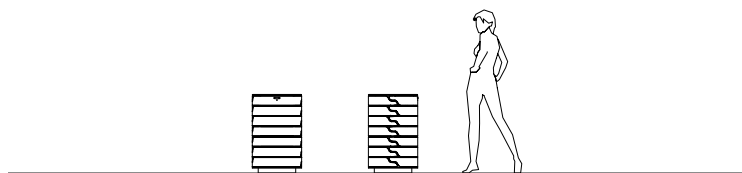

## CESTUM

Designer:	<b>Antonio Citterio</b> con Toan Nguyen	
Dimensions and weight Dimensiones y peso:	Ø 402 mm H 745 mm	42 kg
Capacity/Capacidad:	75 lt	
Materials/Materiales:	Powder coated aluminum + Powder coated steel Aluminio pintado + Acero pintado	
Fixing/Fijación:	Pre-drilled for anchors Predisposición para tacos	
Accessories/Accesorios:	Ashtray Cenicero	



Litter bin composed of a truncated-conical structure in laser-perforated steel sheet with floral patterns. It is equipped with a lid with a central hole, which can be opened through snap lock. The litter bin is equipped with steel sheet inner liner.

Papelera de forma troncocónica compuesta de una estructura en chapa de acero perforada a láser con motivos vegetales, dotada de una tapa con orificio central, que se abre con cerradura a presión. La papelera dispone de un contenedor interno en chapa de acero.

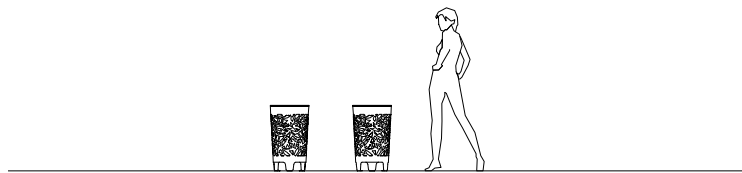

## CONGA

Designer:	Aurel Design Urbain	
Dimensions and weight Dimensiones y peso:	Ø 400 mm H 680 mm	16 kg
Capacity/Capacidad:	30 lt	
Materials/Materiales:	Powder coated steel or Corten steel Acero pintado o Acero Corten	
Fixing/Fijación:	Pre-drilled for anchors Predisposición para tacos	





## CORTE

Designer:	Betancourt design
Dimensions and weight Dimensiones y peso:	Ø 372 mm H 910 mm (+ 200 mm) 20 kg
Capacity/Capacidad:	55 lt
Materials/Materiales:	Powder coated steel or Corten steel Acero pintado o Acero Corten
Fixing/Fijación:	Pre-drilled for anchors or Below ground installation Predisposición para tacos o Cimentación

Litter bin composed of a cylindrical steel sheet structure equipped with bag holder ring and a vertical support in steel plate, with stainless steel tube spacer.

Papelera compuesta de una estructura cilíndrica en chapa de acero dotada de aro para la sujeción de bolsas y de un soporte vertical con base en acero, con separadores en tubo de acero Inoxidable.

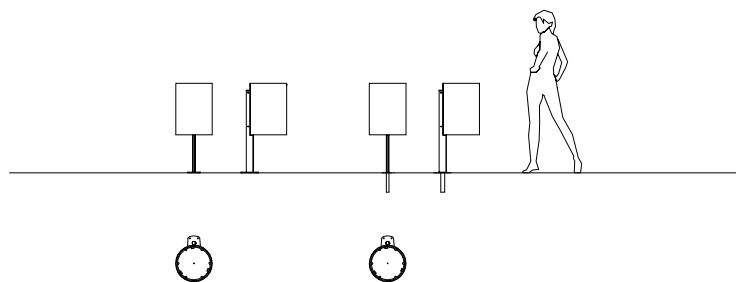



Cylindrical litter bin in HPC (High Performance Concrete) equipped with a Stainless steel opening lid with central hole with lock and with a bag holder ring along the internal circumference. The litter bin is provided with recess at the base.

Papelera con forma cilíndrica realizada en HPC (High Performance Concrete), dotada de una tapa con orificio central en acero Inoxidable, que se abre con cerradura y equipado de aro para la sujeción de bolsas encajado en la circunferencia interna. La papelera está dotada de un rebajo en la base.

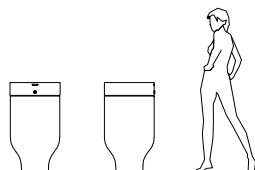

## CUP

Designer:	Staubach & Kuckertz	
Dimensions and weight Dimensiones y peso:	Ø 520 mm H 920 mm	160 kg
Capacity/Capacidad:	68 lt	
Materials/Materiales:	HPC (High Performance Concrete) + Powder coated steel HPC (High Performance Concrete) + Acero pintado	
Finishes/Acabados:	HPC Velluto - Natural smooth HPC Velluto - Liso natural	
Fixing/Fijación:	Pre-drilled for anchors Predisposición para tacos	



ECOMIX





Truncated pyramid litter bin made of steel sheet with a cast aluminium rain cover equipped with a lock and integrated ashtray. The cover is available either in four different colours for separate collection or in monochrome version. The litter bin is equipped with bag holder ring along the internal perimeter.

Papelera en forma tronco piramidal piramidal en chapa de acero con cobertura para la lluvia en fundición de aluminio, dotada de cerradura y de cenicero integrado. La cobertura puede ser de cuatro colores diferentes, para la recogida selectiva de basura o monocromático. La papelera dispone de un aro para la sujeción de bolsas en todo el perímetro interno.

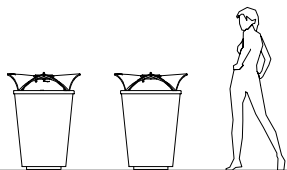

Corten steel  
Acero Corten



Powder coated steel  
Acero pintado



Stainless steel  
Acero Inox



## ECOMIX

Designer:	Raffaele Lazzari	
Dimensions and weight Dimensiones y peso:	755x755x990 mm	50 kg
Capacity/Capacidad:	200 lt	
Materials/Materiales:	Powder coated aluminum + Powder coated steel or Corten steel or Stainless steel Aluminio pintado + Acero pintado o Acero Corten o Acero Inox	
Finishes/Acabados:	Pre-drilled for anchors Predisposición para tacos	
Fixing/Fijación:	Custom graphics Gráficas personalizadas	





## ECOSIDE

Designer:	Alfredo Tasca	
Dimensions and weight Dimensiones y peso:	362x368x942 mm	33 kg
	490x368x942 mm	38 kg
Capacity/Capacidad:	70 lt 100 lt	
Materials/Materiales:	Powder coated steel or Stainless steel Acero pintado o Acero Inox	
Fixing/Fijación:	Pre-drilled for anchors Predisposición para tacos	
Accessories/Accesorios:	Custom graphics Gráficas personalizadas	



Collection of rectangular litter bins composed of a supporting structure in steel tube, a sheet metal covering with rain cover, a front door, drop-down opening with gas pistons, equipped with bag holder ring with elastic and snap lock. Two sizes are available, with or without upper ashtray. The litter bins can be placed side by side to create islands for separate collection.

Colección de papeleras de forma rectangular, compuesta de una estructura portante en tubo de acero, revestida con chapa con cobertura para la lluvia, con puerta frontal abatible con pistones a gas, dotada de aro para la sujeción de bolsas con elástico y cierre a presión. Disponible en dos dimensiones, con o sin cenicero en la parte superior. Las papeleras pueden posicionarse una al lado de la otra, para crear islas, para la recogida selectiva de basura.

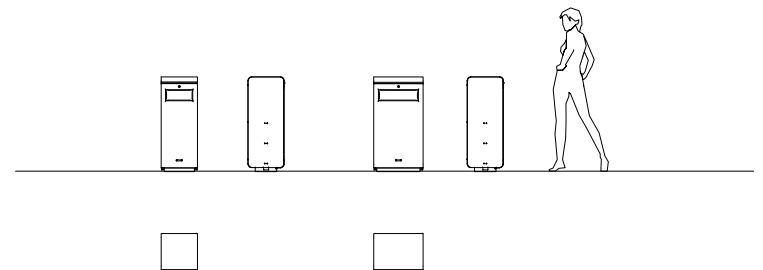

HILL







Modular collection of square litter bins composed of steel sheet structures and opening lids. Two versions are available: one equipped with conveyors and bag holder ring, the other with a lid with holes, suitable for the separate collection of plastic cups. The litter bins can be placed side by side, through a spacer, to create islands for separate collection.

Colección modular de papeleras con forma cuadrangular compuesta por estructura en chapa de acero y tapa abatible. Disponible en dos versiones: una equipada con una sola apertura y aro para la sujeción de bolsas, la otra compuesta por una tapa con orificios, especialmente diseñada para la recogida separada de vasos de plástico. Las papeleras se pueden colocar una al lado de la otra, utilizando un espaciador, para crear islas, para la recogida selectiva de basura.

## HILL

Designer:	Metalco Design
Dimensions and weight Dimensiones y peso:	300x300 mm H 730 mm 10 kg
Capacity/Capacidad:	40 lt
Materials/Materiales:	Powder coated steel Acero pintado
Fixing/Fijación:	Freestanding (indoor only) Apoyo (interiores)
Accessories/Accesorios:	Custom graphics Gráficas personalizadas

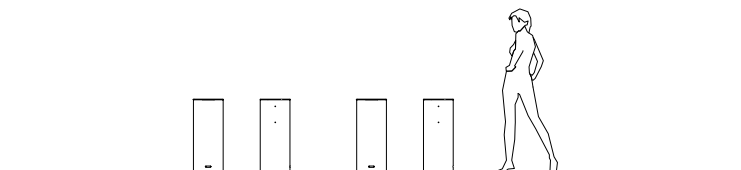

ERMES | ERMES WALL







Collection of cylindrical litter bins composed of a rain cover, a structure with drop-down opening, equipped with snap lock and bag holder ring. Three models are available: one with a bracket for wall fixing, one prepared for pre-existing pole fixing, one equipped with vertical support. All three models can be provided with or without stainless steel ashtray.

Colección de papeleras de forma cilíndrica compuesta de una cobertura para la lluvia, de una estructura con apertura abatible, equipada de cerradura a presión y aro para la sujeción de bolsas. Disponible en tres modelos: uno dotado con soporte para su fijación a muro, otro predispuesto para la fijación a un poste ya existente, uno dotado con el poste. Los tres modelos pueden suministrarse con o sin cenicero en acero Inoxidable.

## ERMES | ERMES WALL

Designer:	Staubach & Kuckertz		
Dimensions and weight Dimensiones y peso:	ERMES Ø 372 mm H 1034 mm	30 kg	
	ERMES WALL Ø 372 mm H 735 mm	21 kg	
Capacity/Capacidad:	55 lt		
Materials/Materiales:	Powder coated steel or Stainless steel Acero pintado o Acero Inox		
Fixing/Fijación:	Pre-drilled for anchors or Below ground installation or Fixing to an existing pole or Wall fixing Predisposición para tacos o Cimentación o Fijación a poste existente o Fijación a muro		

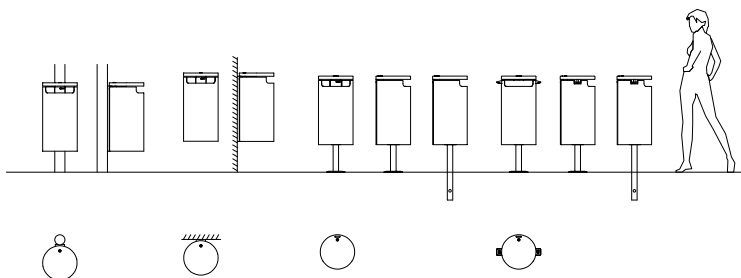



Square litter bin made of HPC (High Performance Concrete) equipped with steel rain cover, which can be opened with a snap lock and which is provided with two side holes for separate collection and a stainless steel plate for the extinguishing of cigarettes with integrated container. The litter bin is equipped with a bag holder ring separated by a divider.

Papelera cuadrangular en HPC (High Performance Concrete), equipada con una cobertura para la lluvia en acero que se puede abrir con una cerradura a presión, equipada con dos orificios laterales para la recogida separada de residuos y placa de cigarrillos en acero Inoxidable con contenedor integrado. La papelera está equipada con dos aros para la sujeción de bolsas, separados por un divisor.

## QUAI

Designer:	Metalco Design
Dimensions and weight Dimensiones y peso:	610x610 mm H 1030 mm 380 kg
Capacity/Capacidad:	65 + 65 lt
Materials/Materiales:	HPC (High Performance Concrete) + Powder coated steel HPC (High Performance Concrete) + Acero pintado
Finishes/Acabados:	HPC Velluto - Natural smooth HPC Velluto - Liso natural
Fixing/Fijación:	Freestanding Apoyo
Accessories/Accesorios:	Stainless steel plate with custom graphics Placa Inox con gráficas personalizadas

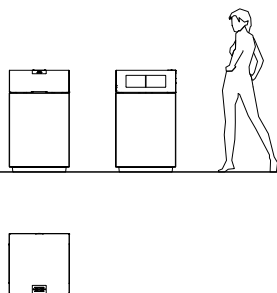



COVER 240







Litter bin in steel composed of a steel tube supporting structure, covered by three side panels, an inclined rain cover, a front door equipped with lock and a hole with conveyor for waste introduction. The structure is designed to accommodate inside a trash can, removable, with a capacity of 240 L (not included). The litter bin can be placed side by side to create islands for separate collection.

Papelera de acero, compuesta por una estructura portante en tubular de acero, revestida por tres paneles laterales, por una cobertura antilluvia inclinada, por una puerta frontal dotada de cerradura y de orificio para la introducción de los residuos. La estructura está diseñada para contener en su interior un cubo de basura de capacidad 240 L (no incluido). Las papeleras se pueden unir para crear islas para la recogida selectiva de basura.

## COVER 240

Designer:	Metalco Design
Dimensions and weight Dimensiones y peso:	785x810 mm H 1390 mm 106 kg
Capacity/Capacidad:	240 lt
Materials/Materiales:	Powder coated steel Acero pintado
Fixing/Fijación:	Pre-drilled for anchors Predisposición para tacos
Accessories/Accesorios:	Custom graphics Gráficas personalizadas

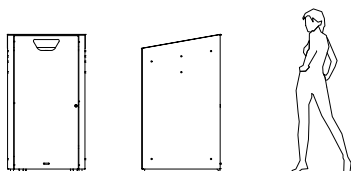





## MARCO BOOM

Designer:	Mattia Li Pomi	
Dimensions and weight Dimensiones y peso:	Ø 520 mm H 795 mm	58 kg
Capacity/Capacidad:	115 lt	
Materials/Materiales:	Powder coated steel Acero pintado	
Fixing/Fijación:	Pre-drilled for anchors Predisposición para tacos	
Accessories/Accesorios:	Internal spacers kit Kit de separadores internos	

MB1



MB2



MB3



Collection of cylindrical litter bins composed of a laser-perforated steel sheet structure with geometric or floral patterns and a concrete base. The litter bin is equipped with a lid, which can be opened through lock, with holes (from one to three) for the introduction of waste. Three versions are available.

Colección de papeleras de forma cilíndrica compuestas de una estructura en chapa de acero perforada a láser con motivos geométricos o florales y de una base en cemento. La papelera está dotada de una tapa, que se abre a través de una cerradura, con orificios (de uno a tres) para la introducción de basura. Disponible en tres versiones.

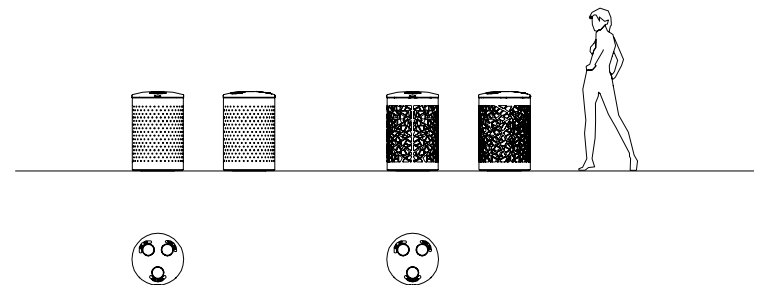



Litter bin made of HPC (High Performance Concrete) equipped with Stainless steel opening lid with central hole, which can be opened with snap lock. It is also equipped with bag holder ring along the internal perimeter.

Papelera realizada en HPC (High Performance Concrete), dotada de tapa con un orificio en acero Inoxidable, la apertura se realiza gracias a la cerradura a presión y equipado de un aro para la sujeción de bolsas, fijado y apoyado en el perímetro interno.

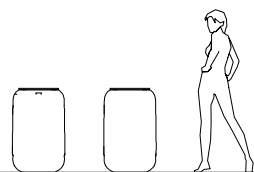

## POD

Designer:	Andrea Morgante & Shiro Studio	
Dimensions and weight	535x600x855 mm	290 kg
Dimensiones y peso:		
Capacity/Capacidad:	70 lt	
Materials/Materiales:	HPC (High Performance Concrete) + Stainless steel HPC (High Performance Concrete) + Acero Inox	
Finishes/Acabados:	HPC Velluto - Natural smooth HPC Velluto - Liso natural	
Fixing/Fijación:	Pre-drilled for anchors Predisposición para tacos	



PACK



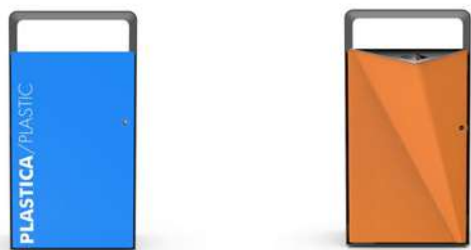

PL

PS



Collection of rectangular steel litter bins composed of a thick steel sheet supporting structure and two specular panels, of which one is fixed and one which opens with snap lock. The litter bin is equipped with rain cover and bag holder ring. Two versions are available, with or without ashtray with integrated container. The version with ashtray provides a protrusion equipped with a stainless steel plate for the extinguishing of cigarettes. The litter bins can be placed side by side to create islands for separate collection.

Colección de papeleras con forma rectangular compuestas de una estructura portante realizada con una gruesa lamina de acero y dos paneles especulares, uno fijo y otro abatible, que hace las veces de puerta dotada de cerradura a presión. La papelera está equipada con un aro para la sujeción de bolsas y una cobertura para la lluvia. Disponible en en dos versiones, con o sin cenicero integrado. La versión con el cenicero, está provista de un saliente dotado con una placa en acero Inoxidable para poder apagar los cigarrillos. Las papeleras pueden ponerse uno al lado del otro para crear islas para la recogida selectiva de basura.

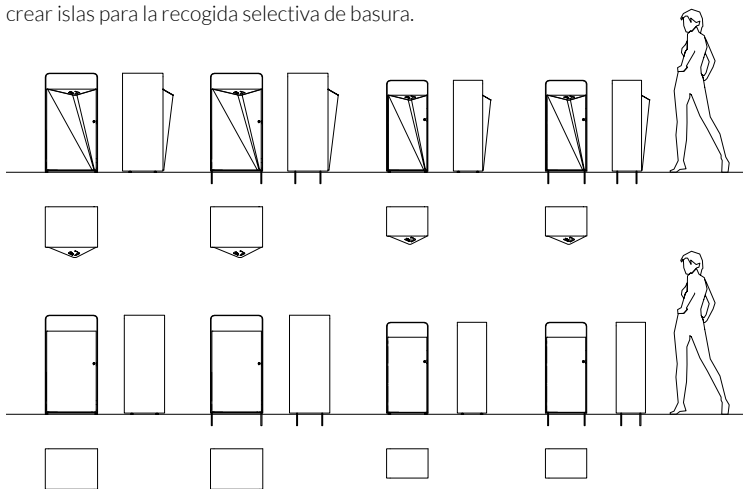

## PACK

Designer:	Massimo Tasca
Dimensions and weight Dimensiones y peso:	410x280x910 mm 46 kg
	520x365x980 mm 63 kg
Capacity/Capacidad:	50 lt 100 lt
Materials/Materiales:	Powder coated steel Acero pintado
Fixing/Fijación:	Installation with threaded bars Cimentación con varillas roscadas
Accessories/Accesorios:	Freestanding fixing kit Kit de pies de apoyo  Custom graphics Gráficas personalizadas





Cylindrical litter bin made of PDM (Reconstituted Stones) equipped with a steel lid with central hole, opening with lock and provided with bag holder ring along the internal perimeter. The litter bin is decorated with horizontal milling and it is equipped with recess at the base.

Papelera de forma cilíndrica realizada en PDM (Piedras Reconstituidas), dotada de una tapa con orificio central en acero Inoxidable, que se abre con cerradura y equipada, a lo largo de todo el perímetro interno, de un aro para la sujeción de las bolsas. La papelera está decorada con ranuras horizontales y dotado de un rebajo en la base.

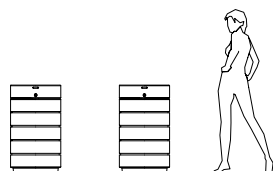

## RUBINO

Designer:	Staubach & Kuckertz
Dimensions and weight Dimensiones y peso:	Ø 520 mm H 902 mm 174 kg
Capacity/Capacidad:	70 lt
Materials/Materiales:	PDM (Reconstituted Stones) + Powder coated steel PDM (Piedras Reconstituidas) + Acero pintado
Finishes/Acabados:	PDM Sandblasted PDM Tratado con chorro de arena
Fixing/Fijación:	Freestanding Apoyo
Accessories/Accesorios:	Inner liner Contenedor interno  Ground fixing kit Kit de fijación al suelo



ROY

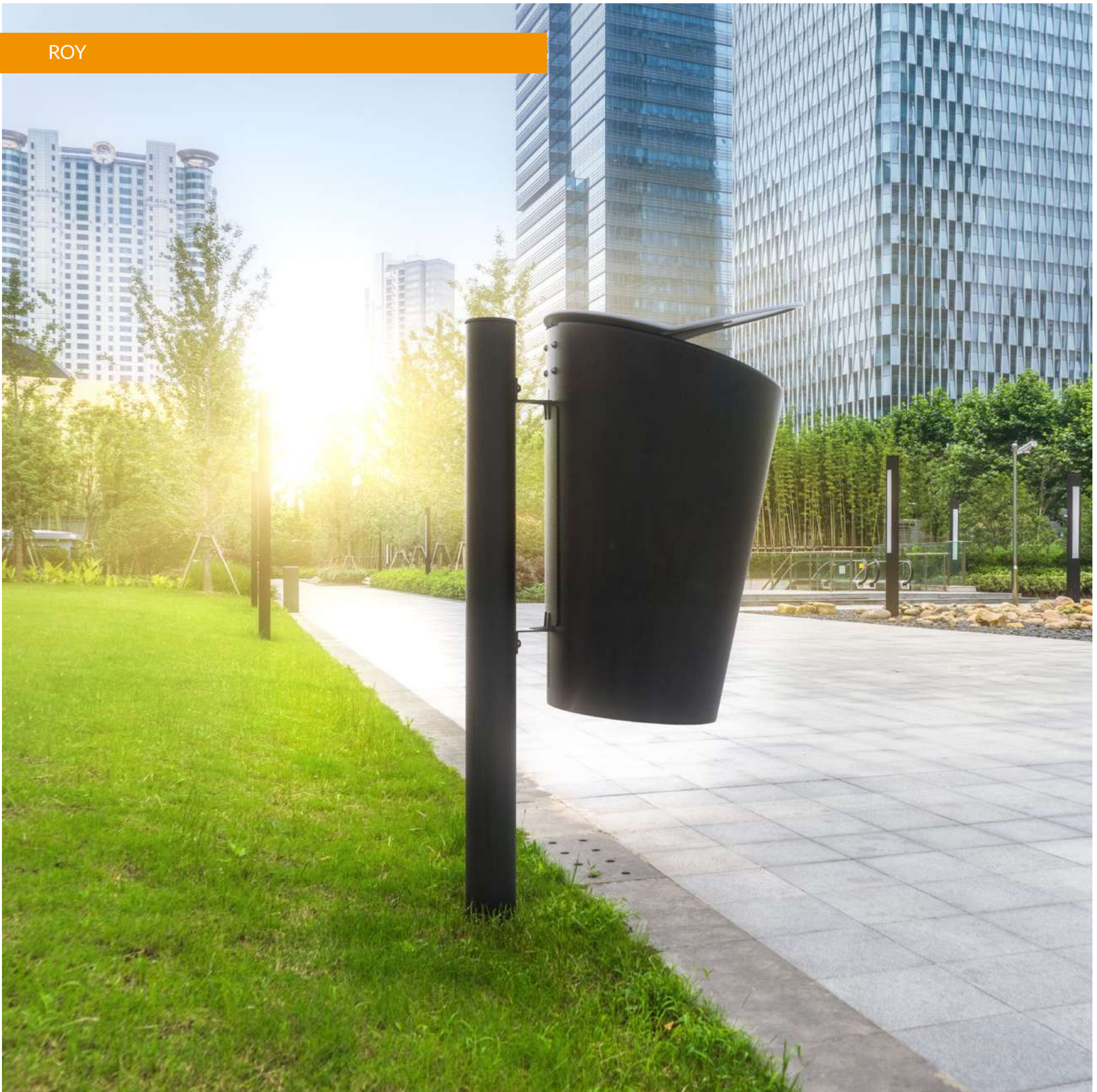





Collection of truncated-conical litter bins composed of a steel sheet structure equipped with bag holder ring with elastic and shaped rain cover, opening with snap lock. Three models are available: one equipped with bracket for wall fixing, one prepared for fixing on an existing pole, one equipped with pole.

Colección de papeleras de forma troncocónica compuestas de una estructura en chapa de acero dotada de aro para la sujeción de bolsas con elástico y de una cobertura para la lluvia perfilada, que se puede abrir con una cerradura a presión. Disponible en tres modelos: uno dotado de soportes para su fijación a muro, otro predispuesto para la fijación a un poste ya existente, uno dotado con el poste.

## ROY

Designer:	Massimo Tasca
Dimensions and weight Dimensiones y peso:	565x405 mm H 1015 mm 25 kg
Capacity/Capacidad:	40 lt
Materials/Materiales:	Powder coated steel Acero pintado
Fixing/Fijación:	Pre-drilled for anchors or Below ground installation Predisposición para tacos o Cimentación

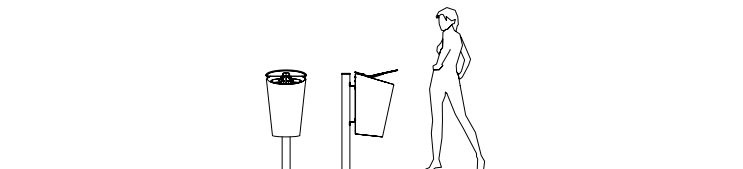

SBIN





NOT STANDARD CONFIGURATION



LITTERBINS

Litter bin composed of a supporting structure in UHPC (Ultra High Performance Concrete) and two specular panels in sheet steel, of which one is fixed and one which opens with snap lock. The litter bin is equipped with a bag holder ring.

Papelera formada por una estructura portante en UHPC (Ultra High Performance Concrete) e dos paneles especulares en chapa de acero, uno fijo y otro abatible, que hace las veces de puerta dotada de cerradura a presión. La papelera está equipada con un aro para la sujeción de las bolsas.

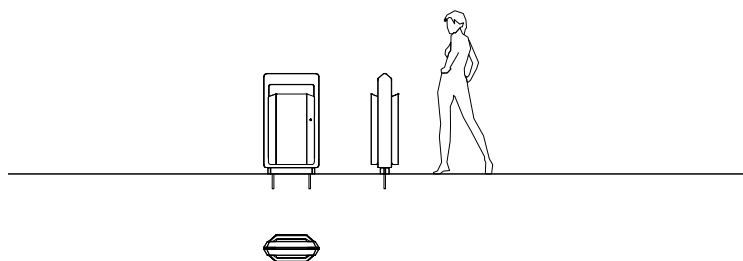

## SBIN

Designer:	Indio Da Costa AUDT	
Dimensions and weight Dimensiones y peso:	560x275 mm H 1010 mm	100 kg
Capacity/Capacidad:	60 lt	
Materials/Materiales:	UHPC (Ultra High Performance Concrete) + Powder coated steel UHPC (Ultra High Performance Concrete) + Acero pintado	
Finishes/Acabados:	UHPC Alfa - Natural smooth UHPC Alfa - Liso natural	
Fixing/Fijación:	Below ground installation Cimentación	

PAPELERAS



## SET

Designer:	Staubach & Kuckertz	
Dimensions and weight Dimensiones y peso:	690x644x930 mm	65 kg
Capacity/Capacidad:	3x60 lt	
Materials/Materiales:	Powder coated steel + Powder coated aluminum Acero pintado + Aluminio pintado	
Fixing/Fijación:	Freestanding (indoor only) Apoyo (interiores)	
Accessories/Accesorios:	Custom graphics Gráficas personalizadas	



Clover-shaped litter bin made of steel sheet, equipped with three inner liners for separate collection and aluminum top lid with three holes and sheet metal conveyors. The lid can be lifted thanks to a gas piston activated by a snap lock.

Papelera con forma de trébol, realizada en chapa de acero, dotado de tres contenedores internos para la recogida selectiva de basura y cobertura superior en aluminio con tres orificios con identificador de color realizados en chapa de acero. La tapa se puede levantar gracias a un pistón a gas, accionable a través de una cerradura a presión.

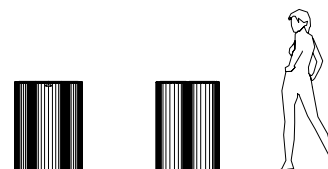





Litter bin made of PDM (Reconstituted Stones), equipped with rain cover in cast aluminum which can be opened with triangular lock and which is equipped with an integrated ashtray. The cover can be coloured either in four different colours for separate collection or in one color only. The litter bin is equipped with bag holder ring with stainless steel anti-theft cable along the internal perimeter.

Papelera realizada con PDM (Piedras Reconstituídas), dotada de cobertura para la lluvia en fundición de aluminio, la apertura es con cerradura triangular y está dotada de un cenicero integrado. La cobertura puede pintarse en cuatro colores diferentes para la recogida selectiva, o en un único color. La papelera está equipada, a lo largo de todo el perímetro interno, de un aro para la sujeción de bolsas.

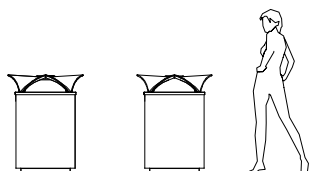

## TOPAZIO

Designer:	Raffaele Lazzari	
Dimensions and weight Dimensiones y peso:	761x761x984 mm	350 kg
Capacity/Capacidad:	130 lt	
Materials/Materiales:	PDM (Reconstituted Stones) + Powder coated aluminum PDM (Pierres reconstitués) + Aluminio pintado	
Finishes/Acabados:	PDM Sandblasted PDM Tratado con chorro de arena	
Fixing/Fijación:	Freestanding Apoyo	
Accessories/Accesorios:	Custom graphics Gráficas personalizadas	

SPENCER COLLECTION

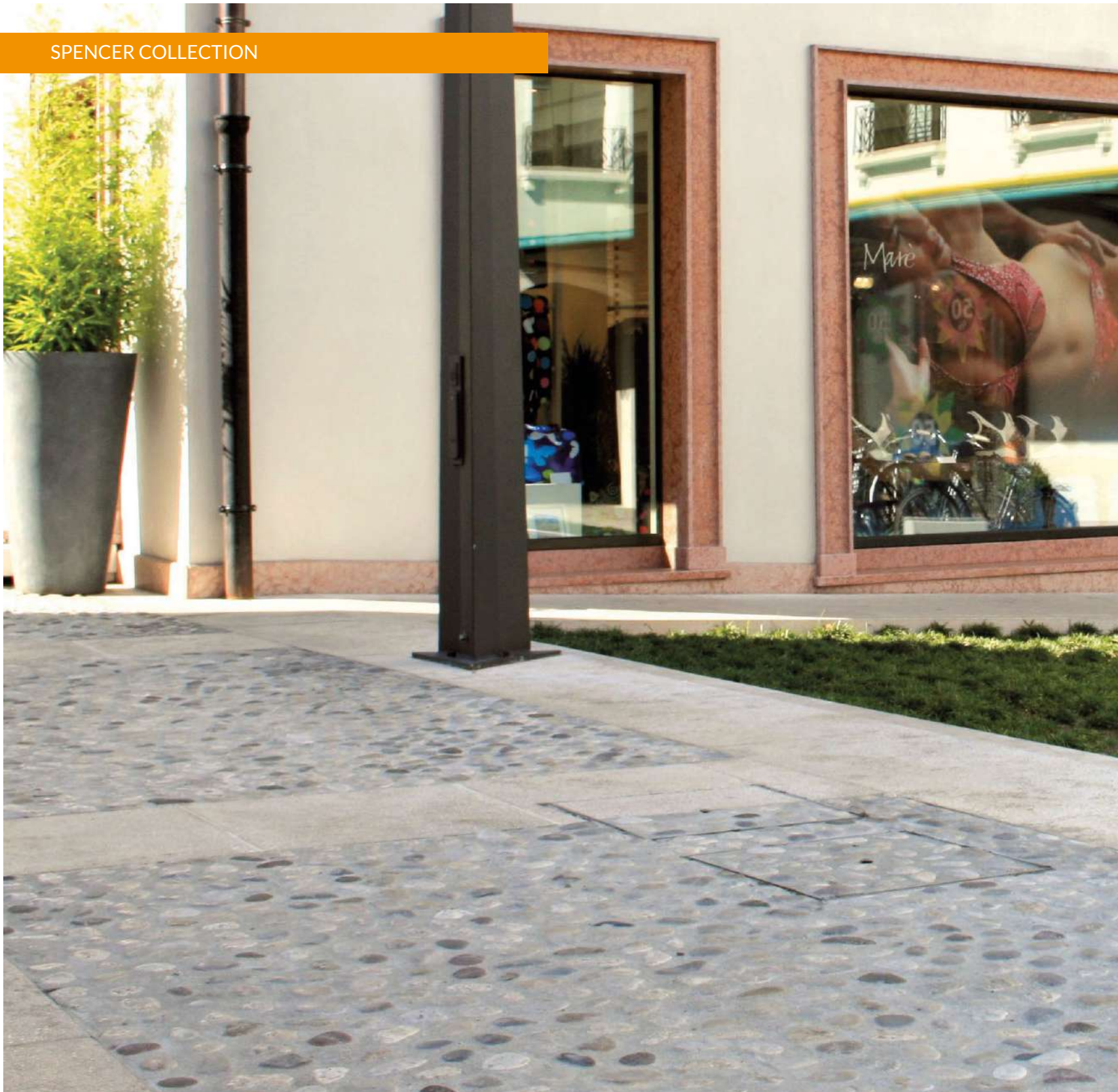







SPENCER C







CORTEN STEEL  
ACERO CORTEN



STAINLESS STEEL  
ACERO INOX



POWDER COATED STEEL  
ACERO PINTADO

Collection of cylindrical steel litter bins equipped with lid with hole, opening with snap lock, and bag holder ring. The litter bins can be placed side by side to create islands for separate collection. Two sizes are available.

Colección de papeleras con forma cilíndrica en acero, dotadas de tapa con orificio, que se abre con cerradura a presión y aro para la sujeción de las bolsas. Las papeleras pueden posicionarse una al lado de la otra, para crear islas, para la recogida selectiva. Disponible en dos tamaños.

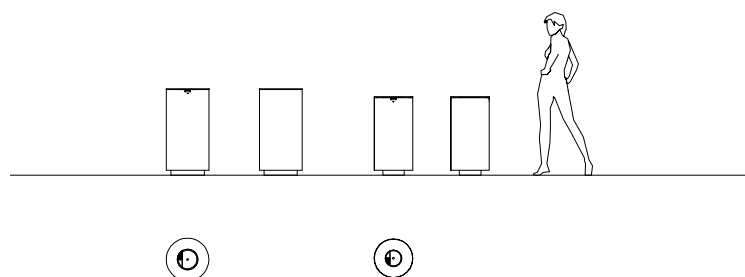

## SPENCER C

Designer:	Alfredo Tasca	
Dimensions and weight	Ø 395 mm H 800 mm	23 kg
Dimensiones y peso:	Ø 435 mm H 880 mm	29 kg
Capacity/Capacidad:	80 lt 120 lt	
Materials/Materiales:	Powder coated steel or Stainless steel or Corten steel Acero pintado o Acero Inox o Acero Corten	
Fixing/Fijación:	Pre-drilled for anchors Predisposición para tacos	
Accessories/Accesorios:	Ashtray Cenicero	
	Stainless steel plate with logo or pictogram Placa Inox para logo o pictograma	
	Inner liner Contenedor interno	
	Stainless steel base (indoor) Zócalo en Inox para apoyo (interiores)	



CORTEN STEEL  
ACERO CORTEN



STAINLESS STEEL  
ACERO INOX



POWDER COATED STEEL  
ACERO PINTADO

## SPENCER E

Designer:	Alfredo Tasca	
Dimensions and weight Dimensiones y peso:	490x295x780 mm	25 kg
Capacity/Capacidad:	75 lt	
Materials/Materiales:	Powder coated steel or Stainless steel or Corten steel Acero pintado o Acero Inox o Acero Corten	
Fixing/Fijación:	Pre-drilled for anchors Predisposición para tacos	
Accessories/Accesorios:	Stainless steel plate with logo or pictogram Placa Inox para logo o pictograma	

Ashtray  
Cenicero

Litter bin composed of a elliptical steel structure equipped with lid with hole for the introduction of waste, openable with snap lock and equipped with bag holder ring. The litter bins can be placed side by side to create islands for separate collection.

Papelera con forma elíptica, dotada de tapa con orificio, apertura con cerradura a presión y aro para la sujeción de bolsas. Las papeleras pueden posicionarse una al lado de la otra, formando islas, para la recogida selectiva de basura.

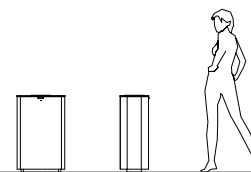





Cylindrical litter bin composed of a steel structure and shaped wood covering, equipped with lid with hole, openable with snap lock and equipped with bag holder ring. The litter bins can be placed side by side to create islands for separate collection.

Papelera de forma cilíndrica con estructura en acero y revestida de madera perfilada, dotada de una tapa con orificio, apertura con cerradura a presión y de aro para la sujeción de bolsas. Las papeleras pueden posicionarse una al lado de la otra, formando islas, para la recogida selectiva de basura.

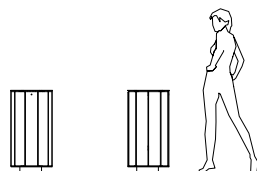

## SPENCER W

Designer:	Alfredo Tasca		
Dimensions and weight	Ø 425 mm H 830 mm		
Dimensiones y peso:	Hardwood   Madera dura	37 kg	
	Larch   Alerce	24 kg	
Capacity/Capacidad:	48 lt		
Materials/Materiales:	Powder coated steel + Hardwood or Larch Acero pintado + Madera dura o Alerce		
Fixing/Fijación:	Pre-drilled for anchors Predisposición para tacos		
Accessories/Accesorios:	Ashtray Cenicero		
	Inner liner Contenedor interno		



SPENCER Q

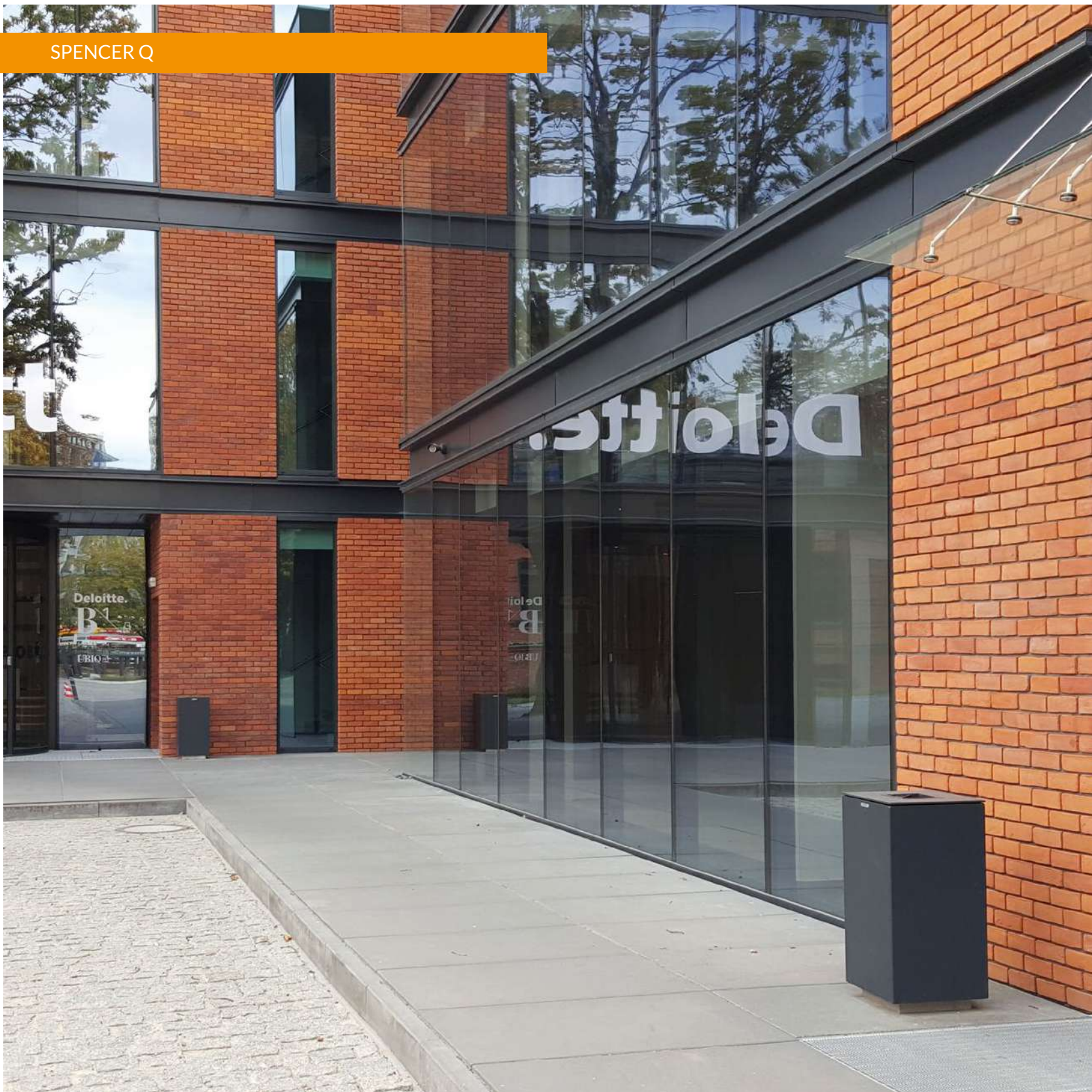





CORTEN STEEL  
ACERO CORTEN



STAINLESS STEEL  
ACERO INOX



POWDER COATED STEEL  
ACERO PINTADO

Litter bin composed of a square steel structure equipped with lid with hole for the introduction of waste, openable with snap lock and equipped with bag holder ring. The litter bins can be placed side by side to create islands for separate collection.

Papelera con forma cuadrada, dotada de tapa con orificio, apertura con cerradura a presión y aro para la sujeción de bolsas. Las papeleras pueden posicionarse una al lado de la otra, formando islas, para la recogida selectiva de basura.

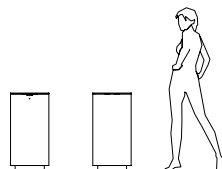

## SPENCER Q

Designer:	Alfredo Tasca	
Dimensions and weight Dimensiones y peso:	395x395x787 mm	33 kg
Capacity/Capacidad:	100 lt	
Materials/Materiales:	Powder coated steel or Stainless steel or Corten steel Acero pintado o Acero Inox o Acero Corten	
Fixing/Fijación:	Pre-drilled for anchors Predisposición para tacos	
Accessories/Accesorios:	Stainless steel plate with logo or pictogram Placa Inox para logo o pictograma	
	Stainless steel base (indoor) Zócalo en Inox para apoyo (interiores)	
	Ashtray Cenicero	

SPENCER R







CORTEN STEEL  
ACERO CORTEN



STAINLESS STEEL  
ACERO INOX



POWDER COATED STEEL  
ACERO PINTADO

Litter bin composed of a rectangular steel structure equipped with lid with hole for the introduction of waste, openable with snap lock and equipped with bag holder ring. The litter bins can be placed side by side to create islands for separate collection.

Papelera con forma rectangular, dotada de tapa con orificio, apertura con cerradura a presión y aro para la sujeción de bolsas. Las papeleras pueden posicionarse una al lado de la otra, formando islas, para la recogida selectiva de basura.

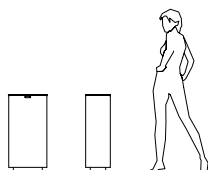

## SPENCER R

Designer:	Alfredo Tasca	
Dimensions and weight Dimensiones y peso:	395x256x787 mm	28 kg
Capacity/Capacidad:	65 lt	
Materials/Materiales:	Powder coated steel or Stainless steel or Corten steel Acero pintado o Acero Inox o Acero Corten	
Fixing/Fijación:	Pre-drilled for anchors Predisposición para tacos	
Accessories/Accesorios:	Stainless steel plate with logo or pictogram Placa Inox para logo o pictograma	
	Stainless steel base (for indoor) Zócalo en Inox para apoyo (para interiores)	
	Ashtray Cenicero	

SPENCER T







CORTEN STEEL  
ACERO CORTEN



STAINLESS STEEL  
ACERO INOX



POWDER COATED STEEL  
ACERO PINTADO

Litter bin composed of a truncated-pyramid steel structure equipped with lid with hole for the introduction of waste, openable with snap lock and equipped with bag holder ring. The litter bins can be placed side by side to create islands for separate collection.

Papelera con forma tronco piramidal, dotada de tapa con orificio, apertura con cerradura a presión y aro para la sujeción de bolsas. Las papeleras pueden posicionarse una al lado de la otra, formando islas, para la recogida selectiva de basura.

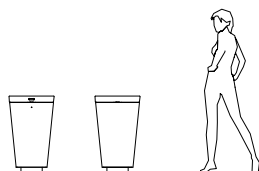

## SPENCER T

Designer:	Alfredo Tasca	
Dimensions and weight Dimensiones y peso:	395x395x787 mm	33 kg
Capacity/Capacidad:	90 lt	
Materials/Materiales:	Powder coated steel or Stainless steel or Corten steel Acero pintado o Acero Inox o Acero Corten	
Fixing/Fijación:	Pre-drilled for anchors Predisposición para tacos	
Accessories/Accesorios:	Stainless steel plate with logo or pictogram Placa Inox para logo o pictograma	
	Ashtray Cenicero	
	Stainless steel base (for indoor) Zócalo en Inox para apoyo (para interiores)	

SPENCER TC







CORTEN STEEL  
ACERO CORTEN



STAINLESS STEEL  
ACERO INOX



POWDER COATED STEEL  
ACERO PINTADO

Litter bin composed of a truncated-conical steel structure equipped with lid with hole for the introduction of waste, openable with snap lock and equipped with bag holder ring. The litter bins can be placed side by side to create islands for separate collection.

Papelera con forma troncocónica, dotada de tapa con orificio, apertura con cerradura a presión y aro para la sujeción de bolsas. Las papeleras pueden posicionarse una al lado de la otra, formando islas, para la recogida selectiva de basura.

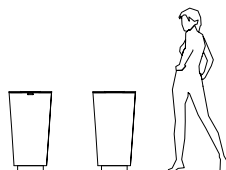

## SPENCER TC

Designer:	Alfredo Tasca
Dimensions and weight Dimensiones y peso:	Ø 435 mm H 800 mm 33 kg
Capacity/Capacidad:	80 lt
Materials/Materiales:	Powder coated steel or Stainless steel or Corten steel Acero pintado o Acero Inox o Acero Corten
Fixing/Fijación:	Pre-drilled for anchors Predisposición para tacos
Accessories/Accesorios:	Stainless steel plate with logo or pictogram Placa Inox para logo o pictograma  Ashtray Cenicero

SPENCER CP





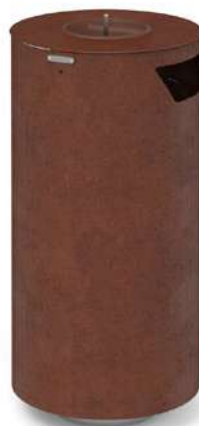

CORTEN STEEL  
ACERO CORTEN



STAINLESS STEEL  
ACERO INOX



POWDER COATED STEEL  
ACERO PINTADO

Collection of litter bins composed of a cylindrical steel structure equipped with two lateral holes for the introduction of waste, a bag holder ring, rain cover with ashtray, openable with snap lock. Two sizes are available.

Colección de papeleras compuestas de una estructura cilíndrica en acero, equipada con dos orificios laterales para la introducción de los residuos, de aro para la sujeción de las bolsas y de cobertura para la lluvia, que se abre con cerradura a presión. Disponible en dos tamaños.

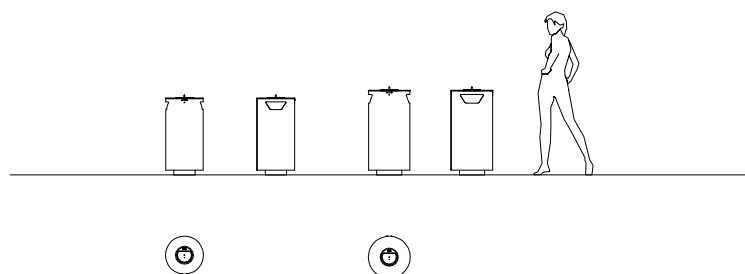

## SPENCER CP

Designer:	Alfredo Tasca	
Dimensions and weight Dimensiones y peso:	Ø 395 mm H 796 mm	22 kg
	Ø 435 mm H 877 mm	26 kg
Capacity/Capacidad:	70 lt 95 lt	
Materials/Materiales:	Powder coated steel or Stainless steel or Corten steel Acero pintado o Acero Inox o Acero Corten	
Fixing/Fijación:	Pre-drilled for anchors Predisposición para tacos	
Accessories/Accesorios:	Stainless steel plate with logo or pictogram Placa Inox para logo o pictograma	
	Ashtray Cenicero	



STAINLESS STEEL  
ACERO INOX



POWDER COATED STEEL  
ACERO PINTADO

## SPENCER CPP

Designer:	Alfredo Tasca	
Dimensions and weight Dimensiones y peso:	Ø 355 mm H 976 mm	21 kg
Capacity/Capacidad:	45 lt	
Materials/Materiales:	Stainless steel or Powder coated steel Acero Inox o Acero pintado	
Fixing/Fijación:	Pre-drilled for anchors Predisposición para tacos	
	Ashtray Cenicero	

Litter bin composed of a cylindrical steel structure equipped with two lateral holes for the introduction of waste, a bag holder ring, rain cover with ashtray, openable with snap lock. The litter bin is provided with a vertical support.

Papelera compuesta de una estructura cilíndrica en acero, equipada con dos orificios laterales para la introducción de los residuos, de aro para la sujeción de las bolsas y de cobertura para la lluvia, con cenicero, que se abre con cerradura a presión. La papelera está equipada con un soporte vertical.

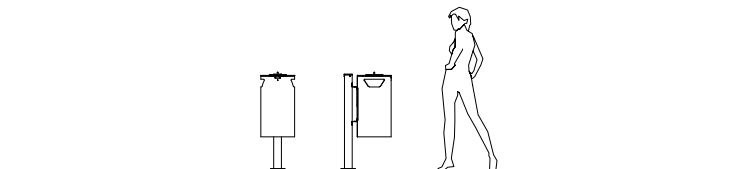





CORTEN STEEL  
ACERO CORTEN

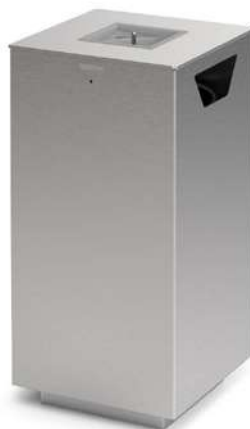

STAINLESS STEEL  
ACERO INOX



POWDER COATED STEEL  
ACERO PINTADO

Litter bin composed of a square steel structure equipped with two lateral holes for the introduction of waste, a bag holder ring, rain cover with ashtray, openable with snap lock.

Papelera compuesta de una estructura cuadrada en acero, equipada con dos orificios laterales para la introducción de residuos, de aro para la sujeción de las bolsas y de cobertura para la lluvia, con cenicero, que se abre con cerradura a presión.

## SPENCER CPQ

Designer:	Alfredo Tasca	
Dimensions and weight Dimensiones y peso:	396x396x787 mm	33 kg
Capacity/Capacidad:	85 lt	
Materials/Materiales:	Powder coated steel or Stainless steel or Corten steel Acero pintado o Acero Inox o Acero Corten	
Fixing/Fijación:	Pre-drilled for anchors Predisposición para tacos	
Accessories/Accesorios:	Stainless steel plate with logo or pictogram Placa Inox para logo o pictograma	
	Ashtray Cenicero	

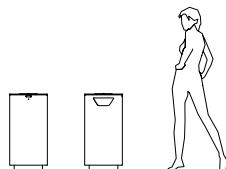



TOP

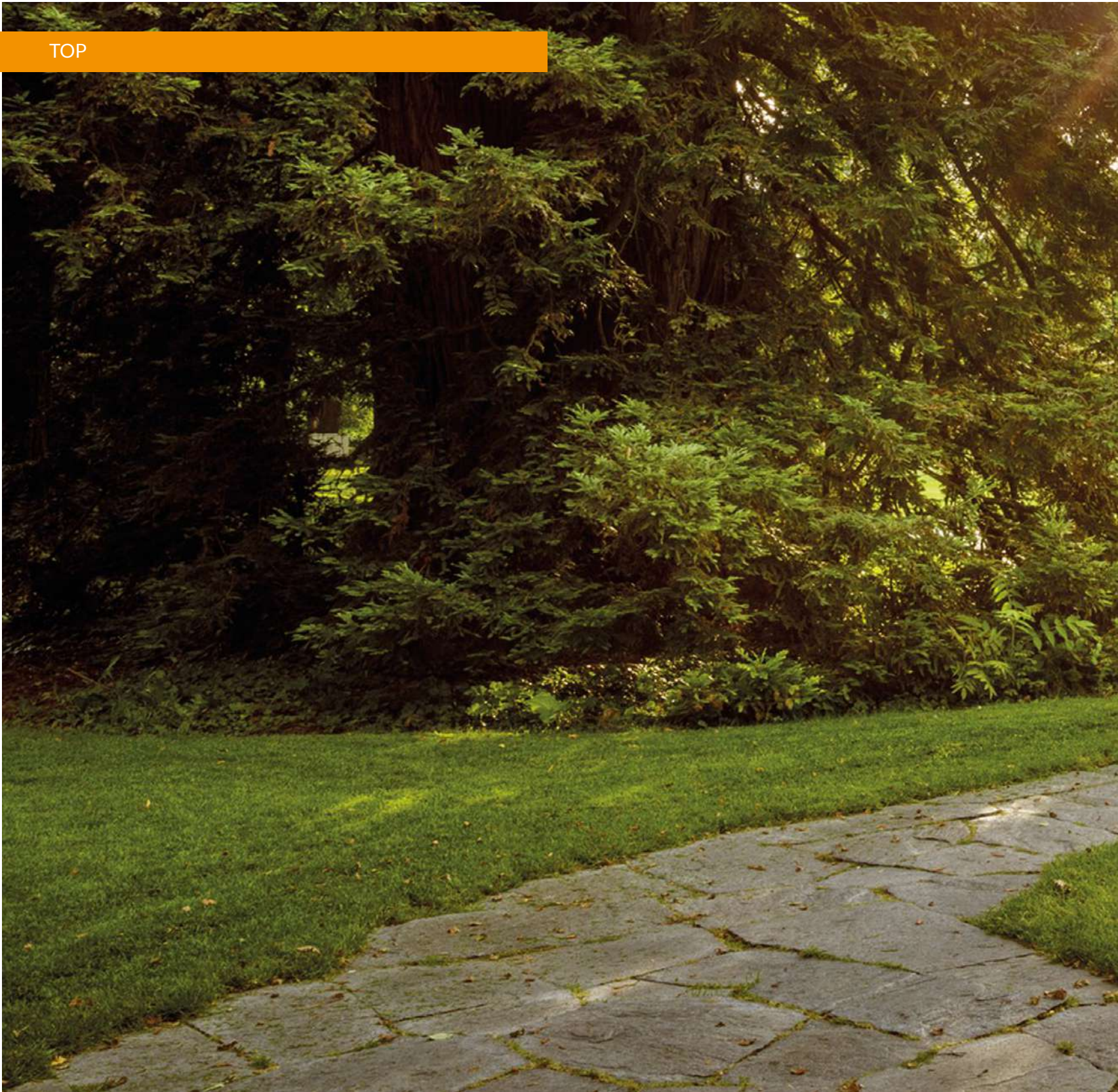







TOP





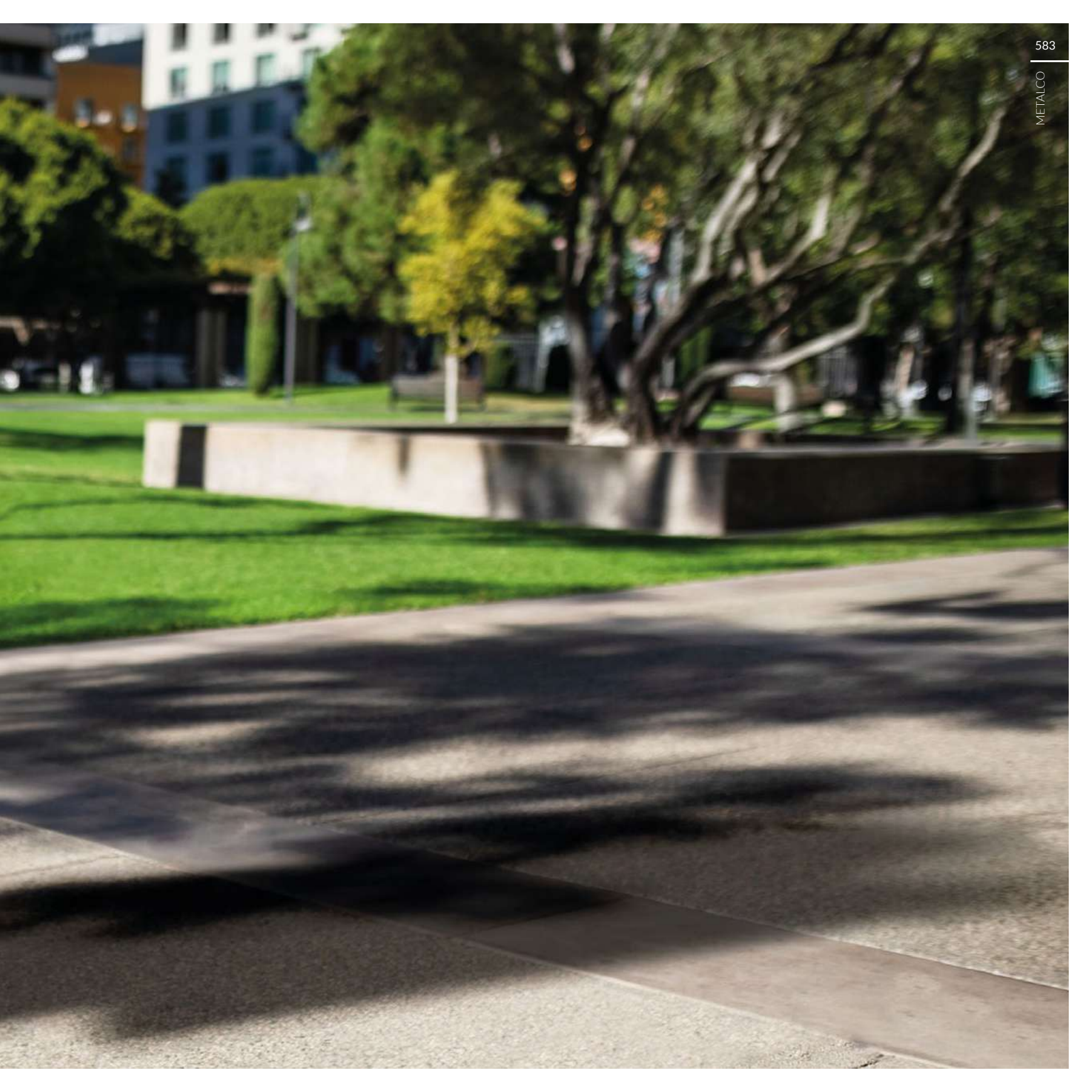

TOP

CONTAINER FOR EMPTYING  
CIGARETTES BUTTS  
CONTENEDOR PARA VACIAR  
COLLARES DE CIGARRILLOS

ELASTIC BAND TO FACILITATE  
THE FIXING OF THE BAG  
ELÁSTICO PARA FACILITAR LA  
FIJACIÓN DE LA BOLSA

TRAY TO FACILITATE  
EXTRACTION OF THE BAG  
BANDEJA PARA FACILITAR LA  
EXTRACCIÓN DEL BOLSO







Collection of litter bins composed of an aluminum structure with door, equipped with an opening for the insertion of waste and snap lock. The litter bin is equipped with rain cover, available with or without cigarette extinguisher plate with integrated container. The structure is equipped with a bag holder ring with elastic and vertical support. Two versions are available, with one or four litter bins, to create islands for separate collection.

Colección de papeleras, compuestas de una estructura en aluminio con puerta, equipada de abertura para la introducción de la basura y de cerradura a presión. La papelera está dotada de cobertura para la lluvia, disponible con o sin placa para apagar los cigarrillos con contenedor integrado. La estructura está equipada de un aro para la sujeción de bolsas con elástico y de un soporte vertical. Disponible en dos versiones con uno o cuatro contenedores, para crear islas, para la recogida selectiva.

## TOP

Designer:	Massimo Tasca + Mattia Li Pomi
Dimensions and weight Dimensiones y peso:	750x750 mm H 1100 mm 80 kg
	345x450 mm H 1100 mm 26 kg
Capacity/Capacidad:	35 lt cad
Materials/Materiales:	Powder coated steel + Powder coated aluminum Acero pintado + Aluminio pintado
Fixing/Fijación:	Pre-drilled for anchors Predisposición para tacos
Accessories/Accesorios:	Custom graphics Gráficas personalizadas  Ashtray Cenicero

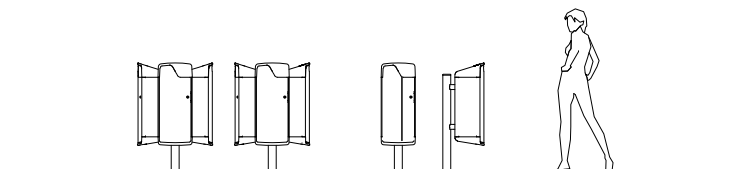



## TULIP | TULIP BIG

Designer:	Sabrina Tubia	
Dimensions and weight Dimensiones y peso:	TULIP Ø 650 mm H 850 mm	31 kg
	TULIP BIG Ø 775 mm H 875 mm	47 kg
Capacity/Capacidad:	70 lt 108 lt	
Materials/Materiales:	Powder coated steel or Stainless steel or Corten steel Acero pintado o Acero Inox o Acero Corten	
Fixing/Fijación:	Pre-drilled for anchors Predisposición para tacos	



Collection of flower shaped litter bins composed of shaped steel "petals" with circular base in stainless steel and bag holder ring in drawn steel. Two sizes are available.

Colección de papeleras con forma floral, compuesta de "pétalos" en acero perfilado, con base circular en acero Inoxidable y aro para la sujeción de bolsas. Disponible en dos tamaños.

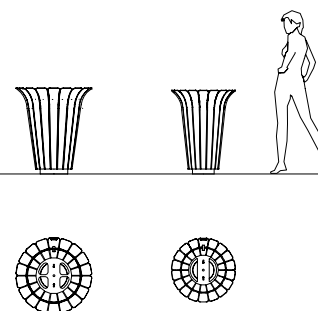





Modular litter bin made of steel sheet and equipped with an aluminum cover with snap lock and with sheet metal conveyor. The litter bins can be placed side by side, through spacer, to create islands for separate collection.

Papelera modular, realizada en chapa de acero, dotada de una tapa en aluminio con cerradura a presión y orificio equipado de identificador de color en chapa de acero. Las papeleras pueden posicionarse una al lado de la otra, a través de un distanciador, para crear islas, para la recogida selectiva de basura.

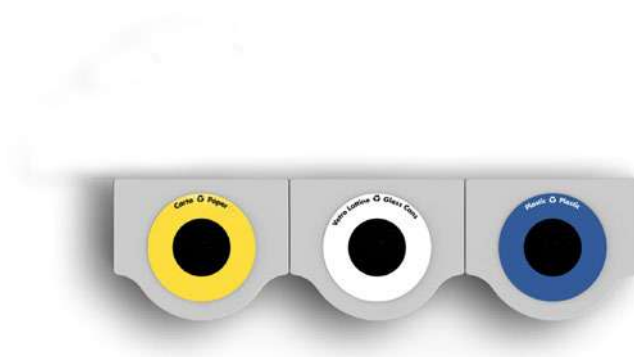
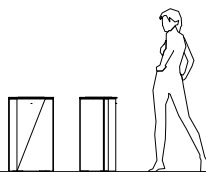

## WAVE

Designer:	Massimo Tasca + Mattia Li Pomi
Dimensions and weight Dimensiones y peso:	455x380 mm H 750 mm 26 kg
Capacity/Capacidad:	50 lt Bag holder   Soporte para bolsa 45 lt Inner liner   Contenedor interno
Materials/Materiales:	Powder coated steel + Powder coated aluminum Acero pintado + Aluminio pintado
Fixing/Fijación:	Freestanding (indoor only) Apoyo (sólo interiores)
Accessories/Accesorios:	Custom graphics Gráficas personalizadas

YES



MEET OUR EXPERT  
WATCHMAKERS  
HELP YOU WITH

- Battery Replacement
- Watch Caseband and Refurbishment
- Watch Crystal Replacement
- Watch Band Replacement
- Professional Cleaning & Polishing

REAL  
happy  
FOOD

TRASH





METALCO

LITTERBINS

Square steel litter bin composed of a thick steel sheet support structure and two specular panels, of which one is fixed and one which opens. Both panels are made of steel tubes. The structure is equipped with snap lock with steel blade. The litter bin is equipped with bag holder ring and with a rain cover inclined at 40°, complete with stainless steel cigarette extinguisher plate with an integrated container.

Papelera con forma cuadrada, en acero, compuesta de una estructura portante realizada con una gruesa chapa de acero y dos paneles especulares, uno fijo y otro abatible, que hace las veces de puerta, ambas realizadas en tubo de acero. La estructura está dotada de cerradura a presión con hoja de acero. La papelera está equipada de un aro para la sujeción de bolsas y cobertura para la lluvia inclinada 40° con una placa en acero inoxidable para apagar los cigarrillos con contenedor integrado.

## YES

Designer:	Alfredo Tasca
Dimensions and weight Dimensiones y peso:	460x393x1125 mm 72 kg
Capacity/Capacidad:	100 lt
Materials/Materiales:	Powder coated steel or Corten steel + Stainless steel Acero pintado o Acero Corten + Acero Inox
Fixing/Fijación:	Pre-drilled for anchors Predisposición para tacos
Accessories/Accesorios:	Custom graphics (with laser cut) Gráficas personalizadas (con corte por láser)

PAPELERAS

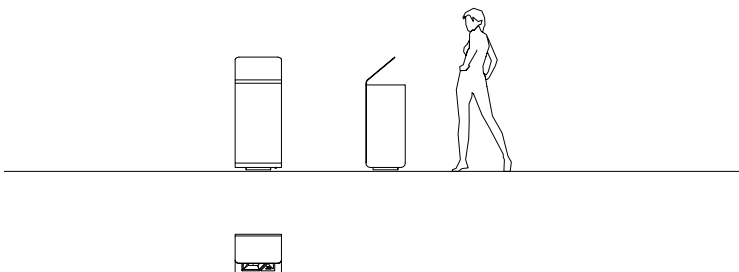

YES W







Square litter bin composed of a thick steel sheet support structure and two specular panels, of which one is fixed and one which opens. Both panels are made of steel tubes covered with vertical slats in Ipe wood. The structure is equipped with snap lock with steel blade. The litter bin is equipped with bag holder ring and with a rain cover inclined at 40°, complete with stainless steel cigarette extinguisher plate with an integrated container.

Papelera de forma cuadrada compuesta de una estructura portante realizada con una gruesa chapa de acero y dos paneles especulares, uno fijo y otro abatible, que hace las veces de puerta, ambas realizadas en tubo de acero revestido con listones verticales en madera de Ipe. La estructura está dotada de cerradura a presión con hoja de acero. La papelera está equipada de un aro para la sujeción de bolsas y cobertura para la lluvia inclinada 40° con una placa en acero Inoxidable para apagar los cigarrillos con contenedor integrado.

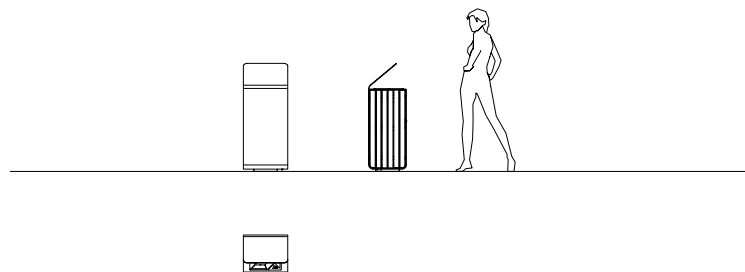

## YES W

Designer:	Alfredo Tasca	
Dimensions and weight Dimensiones y peso:	460x393x1125 mm	72 kg
Capacity/Capacidad:	100 lt	
Materials/Materiales:	Powder coated steel or Corten steel + Ipe Wood Aluminio pintado o Acero Corten + Madera de Ipe	
Fixing/Fijación:	Pre-drilled for anchors Predisposición para tacos	

ALFREDO TASCA  
MASSIMO TASCA  
MATTIA LI POMI  
FEDERICO BONAN  
NICCOLÒ BAREA  
LUIGI VIALETTO

---





# CIGARETTE BINS: GESTURES THAT IMPROVE OUR CITIES

Ceniceros:  
gestos para  
mejorar nuestras  
ciudades



## CICA

Designer:	Niccolò Barea
Dimensions and weight Dimensiones y peso:	300x200 mm (base plate   plato base) 200x100 mm (element   elemento) H 1150 mm 19 kg
Capacity/Capacidad:	1,3 lt
Materials/Materiales:	Powder coated steel or Corten steel + Stainless steel Acero pintado o Acero Corten + Acero Inox
Fixing/Fijación:	Pre-drilled for anchors Predisposición para tacos

Rectangular cigarette bin in stainless steel composed of a removable container, with a cigarette extinguisher top plate, equipped with a slit. The elements are integrated in a supporting structure in steel tube, equipped with door with lock, rain cover and base plate.

Cenicero de forma rectangular en acero Inoxidable compuesto de un contenedor extraíble, con una placa superior para apagar los cigarrillos, provista de una rejilla. Los elementos están integrados en una estructura portante en tubo de acero, equipada de una puerta con cerradura, cobertura para la lluvia y placa base.

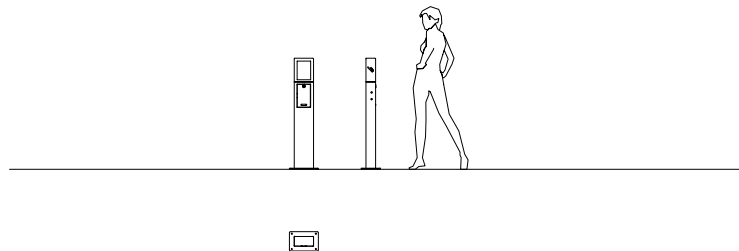





Cylindrical cigarette bin in stainless steel composed of a removable container with lock and equipped with a cigarette extinguisher top plate, equipped with a slit. The elements are integrated in a supporting structure in steel tube.

Cenicero de forma cilíndrica en acero inoxidable compuesto de un contenedor extraíble con cerradura y dotado de una placa superior para apagar los cigarrillos, provista de una rejilla. Los elementos están integrados por una estructura portante en tubo de acero.

## FÙ

Designer:	Luigi Vialto
Dimensions and weight Dimensiones y peso:	Ø 180 mm P 235 mm H 1020 mm 7,5 kg
Capacity/Capacidad:	1 lt
Materials/Materiales:	Powder coated steel + Stainless steel Acero pintado + Acero Inox
Fixing/Fijación:	Pre-drilled for anchors Predisposición para tacos

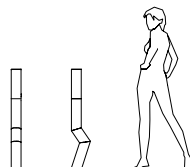



FUMA







Collection of cylindrical cigarette bins in stainless steel composed of a removable container and equipped with a cigarette extinguisher top plate, equipped with a slit. the container is inserted in a steel tube. Two sizes for wall mounting are available. It can also be used as accessory for litter bins.

Colección de ceniceros de forma cilíndrica en acero Inoxidable constituidos por un contenedor extraíble con cerradura y dotados de una placa superior para apagar los cigarrillos, provista de una rejilla. El contenedor está integrado en un tubo de acero. Disponible en dos tamaños, con fijación al muro. Utilizable también como accesorio para las papeleras.

## FUMA

Designer:	Alfredo Tasca
Dimensions and weight Dimensiones y peso:	<p>Ø 80 mm P 98 mm H 302 mm 2,7 kg</p> <p>Ø 106 mm P 123 mm H 302 mm 3,4 kg</p>
Capacity/Capacidad:	<p>0,5 lt</p> <p>1 lt</p>
Materials/Materiales:	<p>Stainless steel</p> <p>Acero Inox</p>
Fixing/Fijación:	<p>On the wall</p> <p>A la pared</p> <p>Pre-drilled for anchors</p> <p>Predisposición para tacos</p>

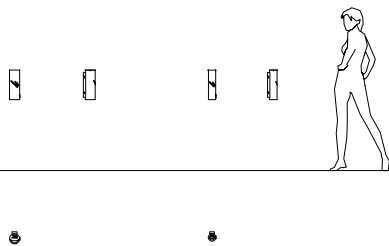



## MÒ

Designer:	Federico Bonan
Dimensions and weight Dimensiones y peso:	250x250 mm (base plate   plato base) 120x120 mm (element   elemento) H 1000 mm 17 kg
Capacity/Capacidad:	1,2 lt
Materials/Materiales:	Powder coated steel or Corten steel + Stainless steel Acero pintado o Acero Corten + Acero Inox
Fixing/Fijación:	Pre-drilled for anchors Predisposición para tacos

Rectangular cigarette bin composed of a steel removable container, with metal sheet coating, with a down-drop opening front door and with cigarette extinguisher top plate, equipped with a slit. The elements are integrated in a supporting structure formed by two vertical steel plates joined by horizontal plates.

Cenicero rectangular formado por un contenedor de acero extraíble, revestido en chapa de acero, con abertura frontal con solapa y placa superior para apagar cigarrillos, provista de rejilla. Los elementos están integrados en una estructura portante, compuesta por dos placas verticales de acero unidas por placas horizontales.

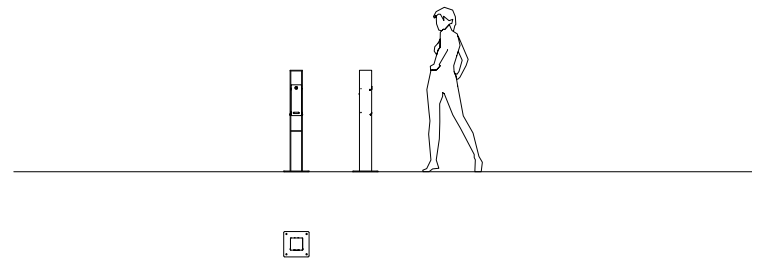





Cylindrical cigarette bin in stainless steel composed of a removable container in steel tube, with cigarette extinguisher top plate, equipped with a slit. The elements are integrated in a supporting structure in steel tube, equipped with door with lock, rain cover and base plate.

Cenicero de forma cilíndrica en acero inoxidable constituido de un contenedor extraíble en tubo, con una placa superior para apagar los cigarrillos, provista de rejilla. Los elementos están integrados en una estructura portante en tubo de acero, provista de puerta con cerradura, cobertura para lluvia y placa base.

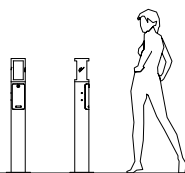

## GENE

Designer:	Massimo Tasca
Dimensions and weight Dimensiones y peso:	Ø 235 mm (base plate   plato base) Ø 140 mm (element   elemento) H 1135 mm 15 kg
Capacity/Capacidad:	1,3 lt
Materials/Materiales:	Powder coated steel + Stainless steel Acero pintado + Acero Inox
Fixing/Fijación:	Pre-drilled for anchors Predisposición para tacos

SCRAMBLER







Cylindrical cigarette bin in stainless steel composed of a removable container with lock and equipped with side holes for the extinguishing of cigarettes and an upper slit. The elements are integrated in a supporting structure in steel tube.

Cenicero de forma cilíndrica en acero inoxidable compuesto de un contenedor extraíble con cerradura y dotado de unos orificios laterales que permiten apagar los cigarrillos, provisto de una rejilla en la parte superior. Los elementos están integrados por una estructura portante en tubo de acero.



## SCRAMBLER

Designer:	Mattia Li Pomi
Dimensions and weight Dimensiones y peso:	Ø 261 mm (base plate   plato base) Ø 121 mm (element   elemento) H 1086 mm 13 kg
Capacity/Capacidad:	1,3 lt
Materials/Materiales:	Powder coated steel + Stainless steel Acero pintado + Acero Inox
Fixing/Fijación:	Pre-drilled for anchors Predisposición para tacos

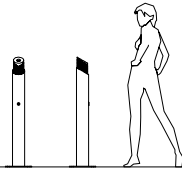

ANTONIO CITTERIO CON TOAN NGUYEN  
INDIO DA COSTA AUDT  
STAUBACK & KUCKERTZ  
UWE KUCKERTZ  
RENATA GIACOMINI  
ALFREDO TASCA  
MASSIMO TASCA  
MATTIA LI POMI  
METALCO DESIGN  
SJIT

---





# BIKE RACKS: THE ROAD TO SUSTAINABLE CITIES

Aparcabicicletas:  
un camino  
hacia ciudades  
sostenibles



Bike rack in steel tube composed of one continuous spiral connected to two horizontal tubes. The structure can be fixed on steel arc supports or on concrete.

Aparcabicicletas en tubo de acero compuesto por una espiral continúa conectada a dos barras horizontales. La estructura se puede fijar sobre soportes con forma de arco en acero o en cemento.

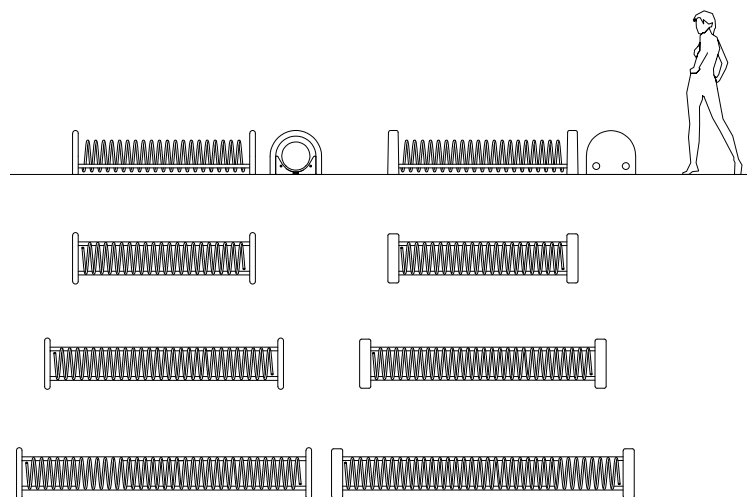

## CICLOS

Designer:	Alfredo Tasca	
Dimensions and weight Dimensiones y peso:	550x1950x470 mm	66 kg
	525x2030x470 mm	140 kg*
	550x2550x470 mm	76 kg
	252x2630x470 mm	147 kg*
	550x3150x470 mm	86 kg
	525x3230x470 mm	156 kg*

Materials/Materiales: Powder coated steel or Stainless steel + Concrete\*  
Acero pintado o Acero Inox + Cemento\*

Finishes/Acabados: Cemento Sandblasted  
Béton tratado con chorro de arena

Fixing/Fijación: Pre-drilled for anchors  
Predisposición para tacos



CARGO

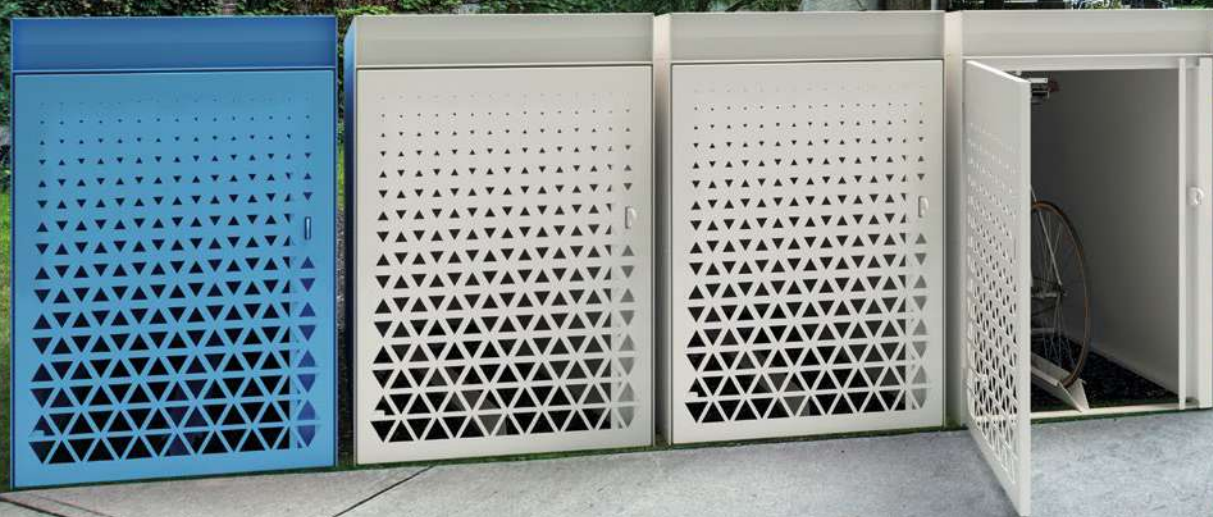



CUSTOMIZED VERSION | VERSIÓN PERSONALIZADA



Modular single bike box with steel sheet structure and perforated steel sheet front door, pre-arranged for closing with padlock.

Box modular individual para bicicletas. con estructura en chapa de acero y puerta frontal en chapa perforada, predispuesta para cerrarse con candado.

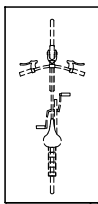
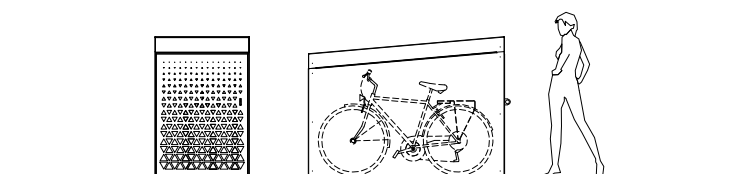

## CARGO

Designer:	Metalco Design
Dimensions and weight Dimensiones y peso:	1970x950 mm H 1400 mm 220 kg
Materials/Materiales:	Powder coated steel Acero pintado
Fixing/Fijación:	Pre-drilled for anchors Predisposición para tacos





## CIRCLE

Designer:	Metalco Design	
Dimensions and weight Dimensiones y peso:	1000x146 mm H 850 mm	7 kg
Materials/Materiales:	Powder coated steel or Stainless steel Acero pintado o Acero Inox	
Fixing/Fijación:	Pre-drilled for anchors Predisposición para tacos	

Circular bike rack in steel tube with a functional steel sheet plate prepared to affix plates with logos or to secure bikes through their frames. It can also be used as a modular barrier.

Aparcabicicletas en tubo de acero de forma circular con pletina funcional en chapa de acero predispuesta para colocar una placa con logo o para encadenar la bicicleta con el marco de la misma. Se puede utilizar también como barrera modular.

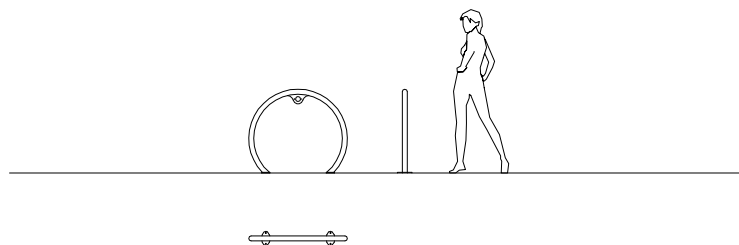



Bike rack in steel composed of two coupled laser-cut steel sheets with an interposed spacer. It can be customized by laser drilling the upper part of the sheets.

Aparcabicicletas en acero formado por dos chapas cortadas al láser acopladas con un distancial interpuesto. El aparabicicletas es personalizable troquelando mediante láser la parte superior de la plancha.

## CLOS

Designer:	Alfredo Tasca
Dimensions and weight Dimensiones y peso:	250x100x950 mm P 20 mm 21 kg
Materials/Materiales:	Powder coated steel or Corten steel or Stainless steel Acero pintado o Acero Corten o Acero Inox
Fixing/Fijación:	Pre-drilled for anchors Predisposición para tacos

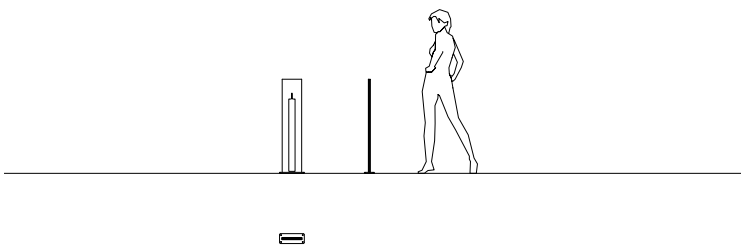





## CRUNA

Designer:	<b>Renata Giacomini</b>
Dimensions and weight Dimensiones y peso:	<b>460x50 mm H 875 mm (+ 200 mm) 9 kg</b>
Materials/Materiales:	<b>Powder coated aluminum Aluminio pintado</b>
Fixing/Fijación:	<b>Below ground installation Cimentación</b>

Bike rack in cast aluminum in different sections with an elliptical shape and a central support. The bike rack allows to secure the bike through the frame.

Aparcabicicletas realizado en fundición de aluminio con secciones variables en forma elíptica con soporte central. Este aparcabicicletas permite encadenar la bicicleta con el marco de la misma.

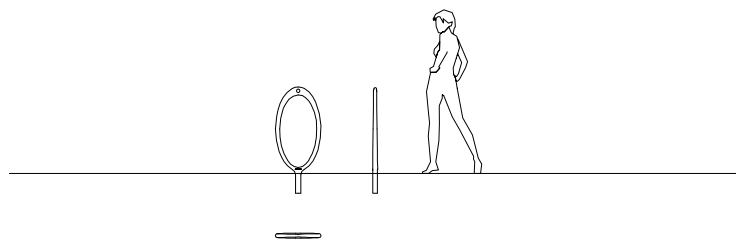



Bike rack in cast aluminum composed of a central body and two half-rings, fixed to it with stainless steel anti-theft screws. It can also be used as a bollard.

Aparcabicicletas en fundición de aluminio, compuesto por un cuerpo central y dos semi-aros fijados al mismo con tornillos antirrobo en acero Inoxidable. Se puede utilizar también como bolardo.

## CYCLUS

Designer:	<b>Antonio Citterio</b> con Toan Nguyen
Dimensions and weight Dimensiones y peso:	<b>583x60 mm H 950 mm (+ 150 mm)</b> <b>10 kg</b>
Materials/Materiales:	<b>Powder coated aluminum</b> <b>Aluminio pintado</b>
Fixing/Fijación:	<b>Pre-drilled for anchors or Below ground installation</b> <b>Predisposición para tacos o Cimentación</b>

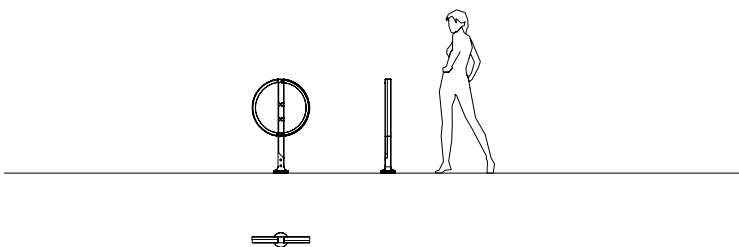





## GUARDIA

Designer:	Alfredo Tasca
Dimensions and weight Dimensiones y peso:	350x100 mm H 958 mm (+ 200 mm) 15 kg
Materials/Materiales:	Powder coated steel or Corten steel + Stainless steel Acero pintado o Acero Corten + Acero Inox
Fixing/Fijación:	Below ground installation Cimentación  Pre-drilled for anchors Predisposición para tacos

Bike rack made of steel plate equipped with a movable stainless steel connecting rod that can be used to secure bikes through the frames.

Aparcabicicletas realizado en plancha de acero con biela móvil en acero Inoxidable, que permite de encadenar la bicicleta a través del marco de la misma.

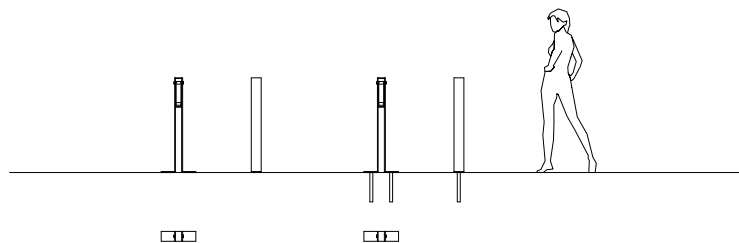



Bike rack made of rectangular steel plate with rounded corners equipped with steel tube support with base plate.

Aparcabicicletas compuesto por una plancha de acero de forma rectangular y con las esquinas redondeadas, dotado de soporte en tubo de acero y placa base.

## INSIDE

Designer:	Stauck & Kuckertz
Dimensions and weight Dimensiones y peso:	240x163 mm H 850 mm (+ 240 mm) 10 kg
Materials/Materiales:	Powder coated steel or Corten steel or Stainless steel Acero pintado o Acero Corten o Acero Inox
Fixing/Fijación:	Pre-drilled for anchors or Below ground installation Predisposición para tacos o Cimentación

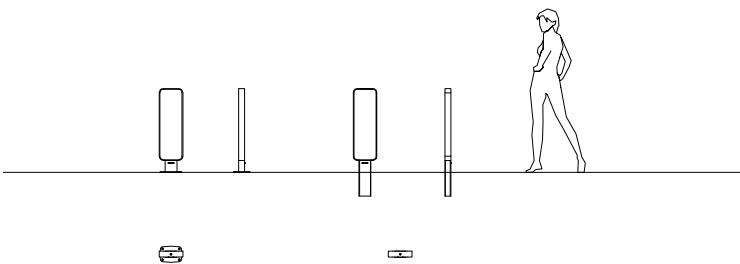



MOMÒ



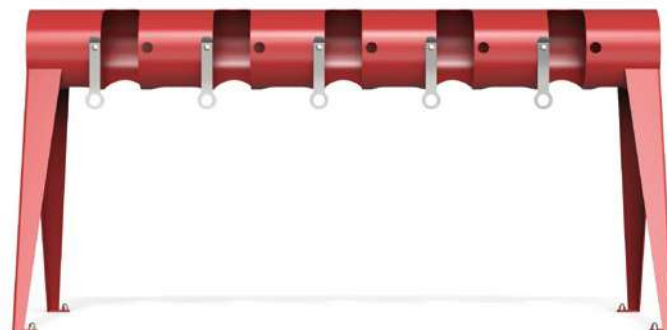

Scooter rack composed of a circular element in powder coated steel, equipped with proper spaces for parking scooters. The rack is equipped with movable stainless steel plate elements, which allow closing by padlock or cable. It is available with powder coated steel supports for ground fixing or for wall fixing.

Estante formado por un elemento circular en acero pintado con rebajos especiales para el estacionamiento ordenado de monopatines. El estante está equipado con un elemento móvil en placas de acero Inoxidable para permitir el cierre con candado o con cable. Disponible con soportes de acero pintado para fijar al suelo o para fijar a la pared.

## MOMÒ

Designer:	Massimo Tasca
Dimensions and weight Dimensiones y peso:	L 1700 mm H 850 mm P 760 mm 37 kg
	L 1700 mm H 850 mm P 485 mm 27 kg
Materials/Materiales:	Powder coated steel + Stainless steel Acero pintado + Acero Inox
Fixing/Fijación:	Pre-drilled for anchors Predisposición para tacos

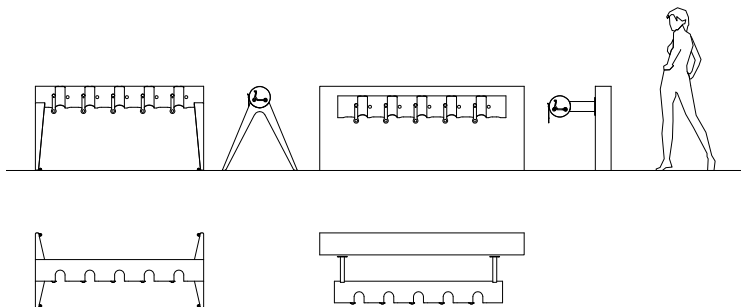



RESET





SERVICE BIKE







Bike repair station composed of a steel structure and an aluminum sheet external case. It is equipped with a set of non-removable tools, with a foot pump for the wheels inflation and a practical support in stainless steel, covered with rubber, to sustain bikes during repair operations.

Columna para la reparación de bicicletas fabricada en estructura de acero, incluye cárter externo en chapa de aluminio. Equipado con un juego de herramientas no extraíbles y con una bomba a pedal para inflar las ruedas, asimismo dispone de un práctico soporte de acero inoxidable, recubierto de goma, sobre el que colocar la bicicleta durante las operaciones de reparación.

## SERVICE BIKE

Designer:	Mattia Li Pomi	
Dimensions and weight Dimensiones y peso:	575x490 mm H 1560 mm	60 kg
Materials/Materiales:	Powder coated aluminum + Powder coated steel Aluminio pintado + Acero pintado	
Fixing/Fijación:	Pre-drilled for anchors Predisposición para tacos	

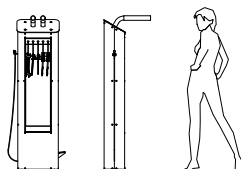

SMERALDO







Bike rack in steel tube composed of one continuous long spiral connected to two horizontal tubes. The structure is fixed to the side bases in PDM (Reconstituted Stones).

Aparcabicicletas en tubo de acero, realizado en una espiral continúa unida a dos tubos horizontales. La estructura metálica está fijada a las bases laterales en PDM (Piedras Reconstituidas).

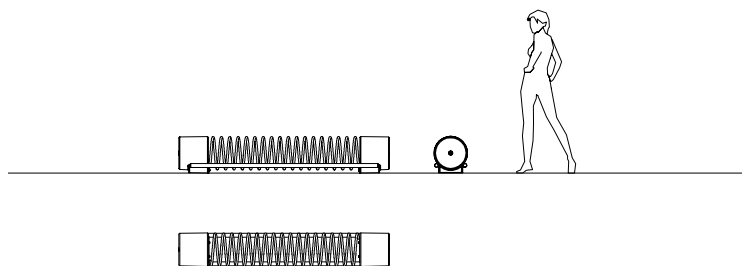

## SMERALDO

Designer:	Alfredo Tasca	
Dimensions and weight Dimensiones y peso:	2140x340 mm H 370 mm	162 kg
Materials/Materiales:	PDM (Reconstituted Stones) + Powder coated steel or Stainless steel PDM (Piedras Reconstituidas) + Acero pintado o Acero Inox	
Finishes/Acabados:	PDM Sandblasted PDM Tratado con chorro de arena	
Fixing/Fijación:	Pre-drilled for anchors Predisposición para tacos	



## CAFÈ

Designer:	Sjit
Dimensions and weight Dimensiones y peso:	650x250 mm H 1004 mm 24 kg
Materials/Materiales:	Powder coated steel or Corten steel or Stainless steel Acero pintado o Acero Corten o Acero Inox
Fixing/Fijación:	Pre-drilled for anchors Predisposición para tacos

Bike rack composed of two semi-circle figures made of a single thick steel plate and joined together by horizontal plates. The bike rack allows to secure the bike through the frame. It can also be used as a modular barrier.

Aparcabicicletas obtenido juntando dos figuras semicirculares, conseguidas a partir del pliegue de una única plancha de acero de gran espesor, unidas por pletinas horizontales. Se puede utilizar también como barrera modular.

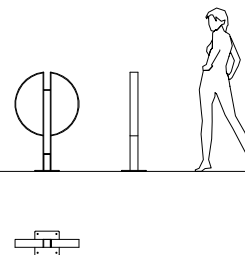





Bike rack in steel tube composed of one continuous spiral that rests on the ground on turned steel cones.

Aparcabicicletas en tubo de acero formado por una espiral continua que se apoya en el suelo sobre unos conos torneados en acero.

## SPYRA

Designer:	Alfredo Tasca	
Dimensions and weight Dimensiones y peso:	2380x750 mm H 780 mm	26 kg
Materials/Materiales:	Powder coated steel or Stainless steel Acero pintado o Acero Inox	
Fixing/Fijación:	Installation with threaded bars Cimentación con varillas roscadas	

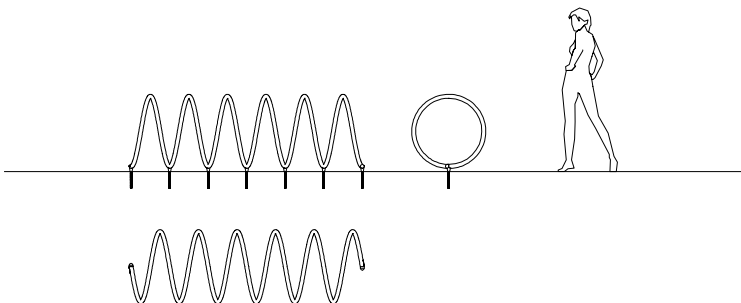



SPYRA CL





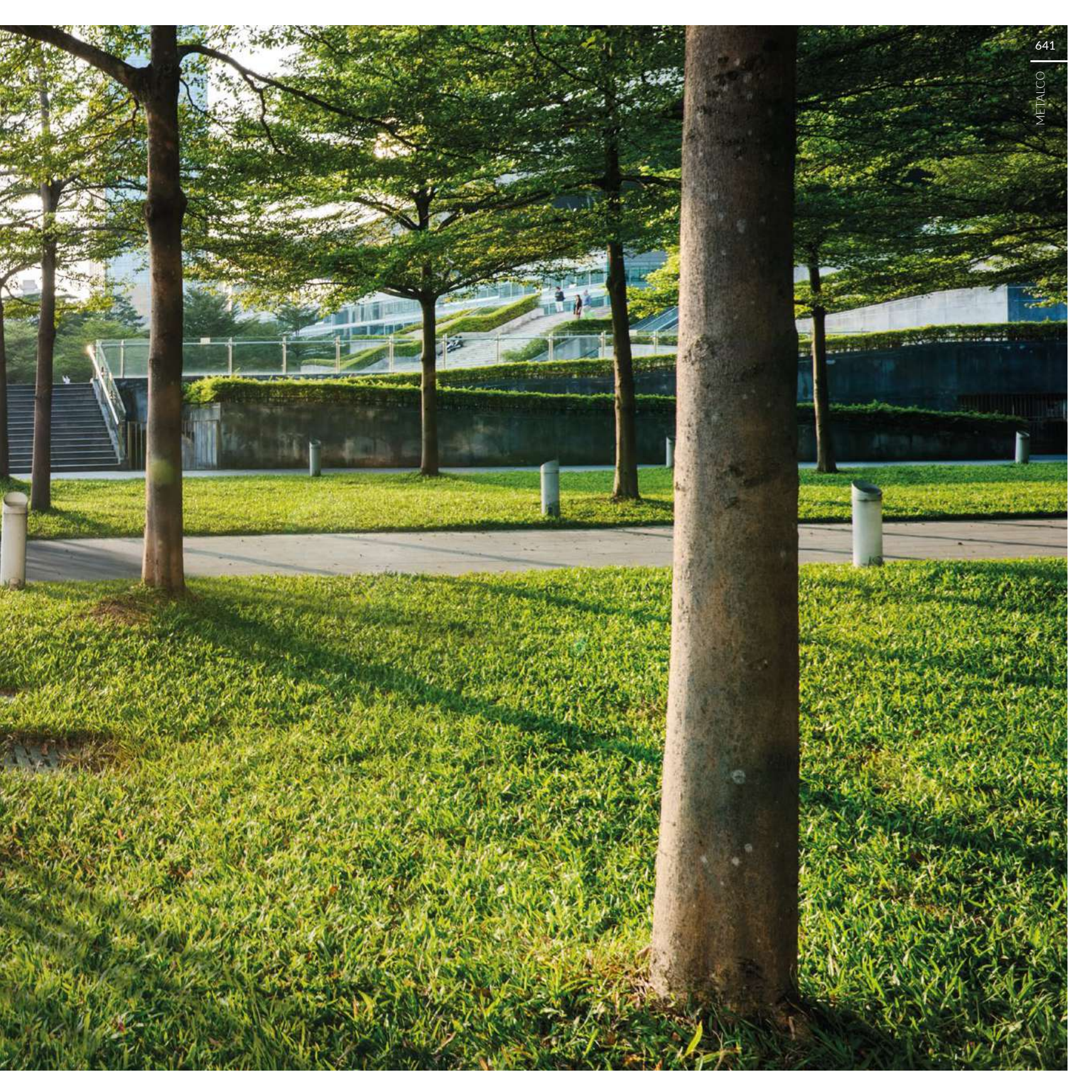



SPYRA CL







Bike rack in steel tube composed of one continuous spiral that rests on the ground on a base in PDM (Reconstituted Stones) or in HPC (High Performance Concrete).

Aparcabicicletas en tubo de acero formado por una espiral continua que se apoya al suelo sobre una base en PDM (Piedras Reconstituidas) o HPC (High Performance Concrete).

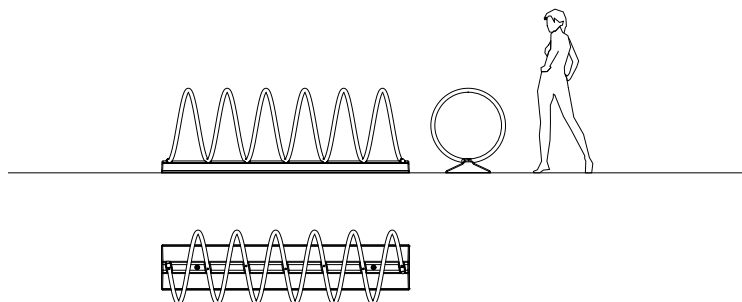

## SPYRA CL

Designer:	Alfredo Tasca
Dimensions and weight: Dimensiones y peso:	2490x750 mm H 850 mm 226 kg
Materials/Materiales:	Powder coated steel or Stainless steel + PDM (Reconstituted Stones) or HPC (High Performance Concrete) Acero pintado o Acero Inox + PDM (Piedras Reconstituidas) o HPC (High Performance Concrete)
Finishes/Acabados:	PDM Sandblasted o HPC Velluto - Natural smooth PDM Tratado con chorro de arena o HPC Velluto - Liso natural
Fixing/Fijación:	Freestanding or Installation with threaded bars Apoyo o Cimentación con varillas roscadas

ANTONIO CITTERIO CON TOAN NGUYEN  
INDIO DA COSTA AUDT  
STAUBACK & KUCKERTZ  
UWE KUCKERTZ  
RENATA GIACOMINI  
ALFREDO TASCA  
MASSIMO TASCA  
MATTIA LI POMI  
METALCO DESIGN  
SJIT

---





# BOLLARDS AND BARRIERS: DEFINE SPACES TO CREATE VALUE

Bolardos y vallas:  
delinear los  
espacios para  
crear valor



## CORALLO

Designer:	<b>Alfredo Tasca</b>
Dimensions and weight Dimensiones y peso:	450x450 mm H 500 mm 245 kg
Materials/Materiales:	PDM (Reconstituted Stones) PDM (Piedras Reconstituidas)
Finishes/Acabados:	Brushed seat + Sandblasted sides Parte superior trabajada con púas rígidas + Laterales tratados con chorro de arena
Fixing/Fijación:	Freestanding Apoyo

Cubic pedestrian bollard made of PDM (Reconstituted Stones) with a recess at the base.

Bolardo peatonal con forma cúbica realizado en PDM (Piedras Reconstituidas), con rebajo perimetral inferior.

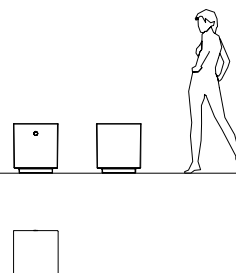



CORALLO





CUBE

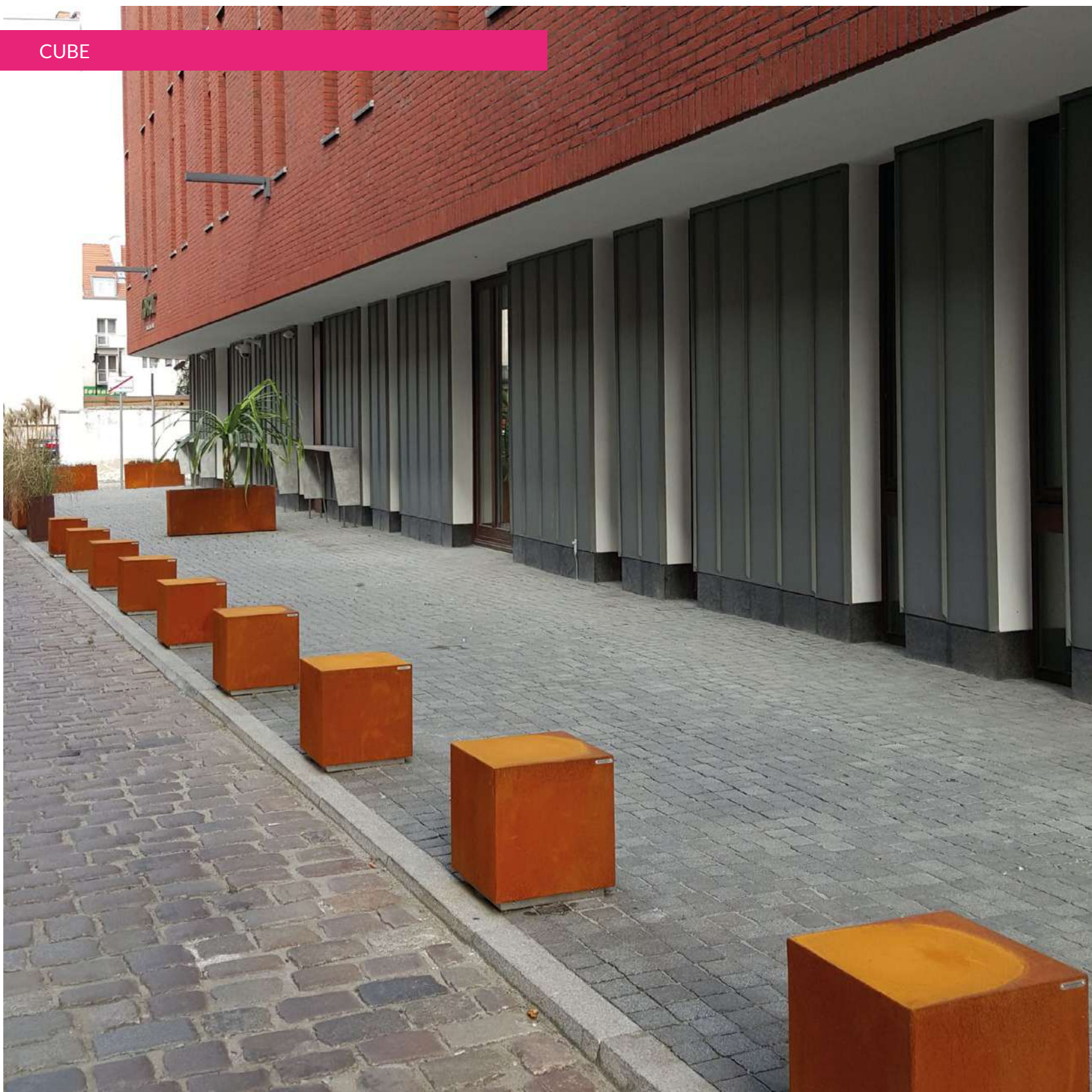





Cubic pedestrian bollard made of steel sheet, with a stainless steel base. Upon request, it can be filled with concrete on request. It can also be used as seat.

Bolardo peatonal de forma cubica, realizado en chapa de acero, con base de apoyo en acero Inoxidable. Bajo pedido, se puede suministrar con relleno de hormigón. El bolardo también se puede utilizar como asiento.

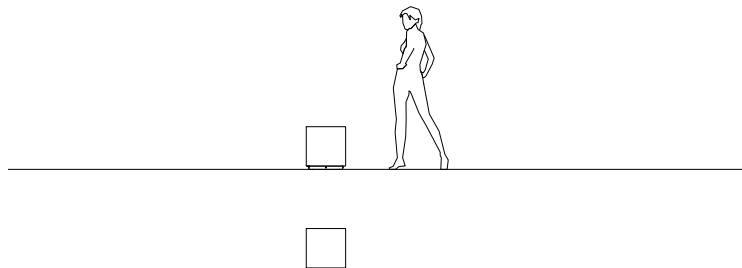

## CUBE

Designer:	Alfredo Tasca	
Dimensions and weight Dimensiones y peso:	400x400 mm H 430 mm	22 kg
Materials/Materiales:	Powder coated steel or Corten steel or Stainless steel Acero pintado o Acero Corten o Acero Inox	
Fixing/Fijación:	Pre-drilled for anchors Predisposición para tacos	



## DIFFUSION NEWS

Designer:	Metalco Design
Dimensions and weight Dimensiones y peso:	<p>Ø 102 mm H 1000 mm (+190 mm) 7,5 kg</p> <p>80x80 mm H 1000 mm (+ 190 mm) 8,5 kg</p> <p>120x60 mm H 1000 mm (+ 190 mm) 9,5 kg</p>
Materials/Materiales:	<p>Powder coated steel or Oxidized steel or Stainless steel Acero pintado o Acero oxidado o Acero Inox</p>
Fixing/Fijación:	<p>Pre-drilled for anchors or Below ground installation Predisposición para tacos o Cimentación</p>

Collection of steel pedestrian bollards, available in round, square or rectangular section. They can be customized with laser cut lettering or pictograms, visible thanks to the addition of a internal steel sheet, that acts as a contrast.

Colección de bolaros peatonales en acero, disponibles en tres modelos de sección redonda, cuadrada o rectangular. Personalizable con palabras o pictogramas perforados a laser, visibles gracias una chapa interna que hace de contraste.

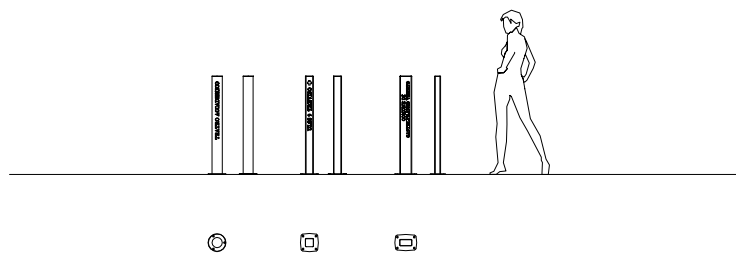





## EXPLOSION

Designer:	Raffaele Lazzari
Dimensions and weight Dimensiones y peso:	70x70 mm H 1000 mm (+200 mm) 9   12 kg
	90x90 mm H 1000 mm (+200 mm) 10   15 kg
Materials/Materiales:	Powder coated steel or Corten steel or Stainless steel Acero pintado o Acero Corten o Acero Inox
Fixing/Fijación:	Pre-drilled for anchors or Below ground installation Predisposición para tacos o Cimentación



Collection of steel pedestrian bollards, composed of a square section tube with diagonal openings at the base. The models, available in two sizes, come with or without a tube core, that acts as contrast.

Colección de bolidos peatonales en acero, compuestos de tubo en sección cuadrada con abertura diagonal a la base. Los modelos, disponibles en dos tamaños, se presentan con o sin núcleo tubular interno, que hace de contraste.

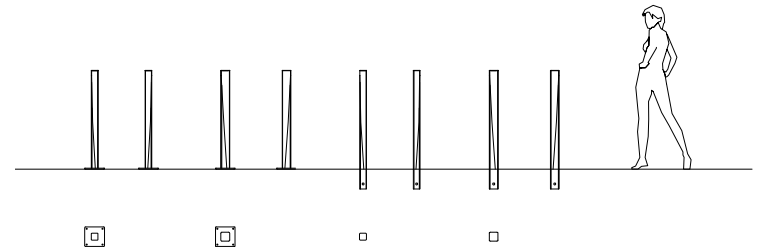



Collection of pedestrian bollards composed of a steel tube structure with stainless steel top. Three different sizes are available.

Colección de bolidos peatonales compuestos de una estructura tubular de acero con parte superior en acero Inoxidable. Disponible en tres tamaños.

#### GENESIS barrier

Modular barrier composed of vertical tube elements with stainless steel top (Genesis H 1010 model). The vertical elements are connected by a steel tube and stainless steel cable, arranged in a "X".

#### GENESIS barrera

Barrera modular constituida de elementos verticales en tubo de acero con parte superior en acero Inoxidable (modelo Genesis H 1010). Los elementos verticales están conectados a un tubo de acero y un cable de acero Inoxidable dispuesto en "X".

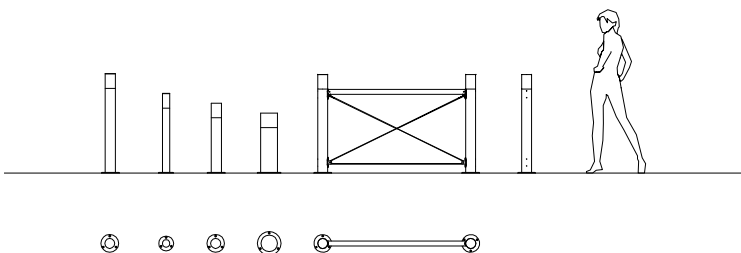

## GENESIS

Designer:

Alfredo Tasca

Dimensions and weight  
Dimensiones y peso:

**GENESIS**

Ø 76 mm H 810 mm (+ 150 mm)

6 kg

Ø 102 mm H 710 mm (+ 150 mm)

7 kg

Ø 102 mm H 1010 mm (+ 150 mm)

9 kg

Ø 168 mm H 610 mm (+ 150 mm)

10 kg

GENESIS barrier - GENESIS barrera  
1500x1000 mm (+ 150 mm)

24 | 15 kg

Materials/Materiales:

Powder coated steel + Stainless steel  
Acero pintado + Acero Inox

Fixing/Fijación:

Pre-drilled for anchors or Below ground  
installation  
Predisposición para tacos o Cimentación



GITTER

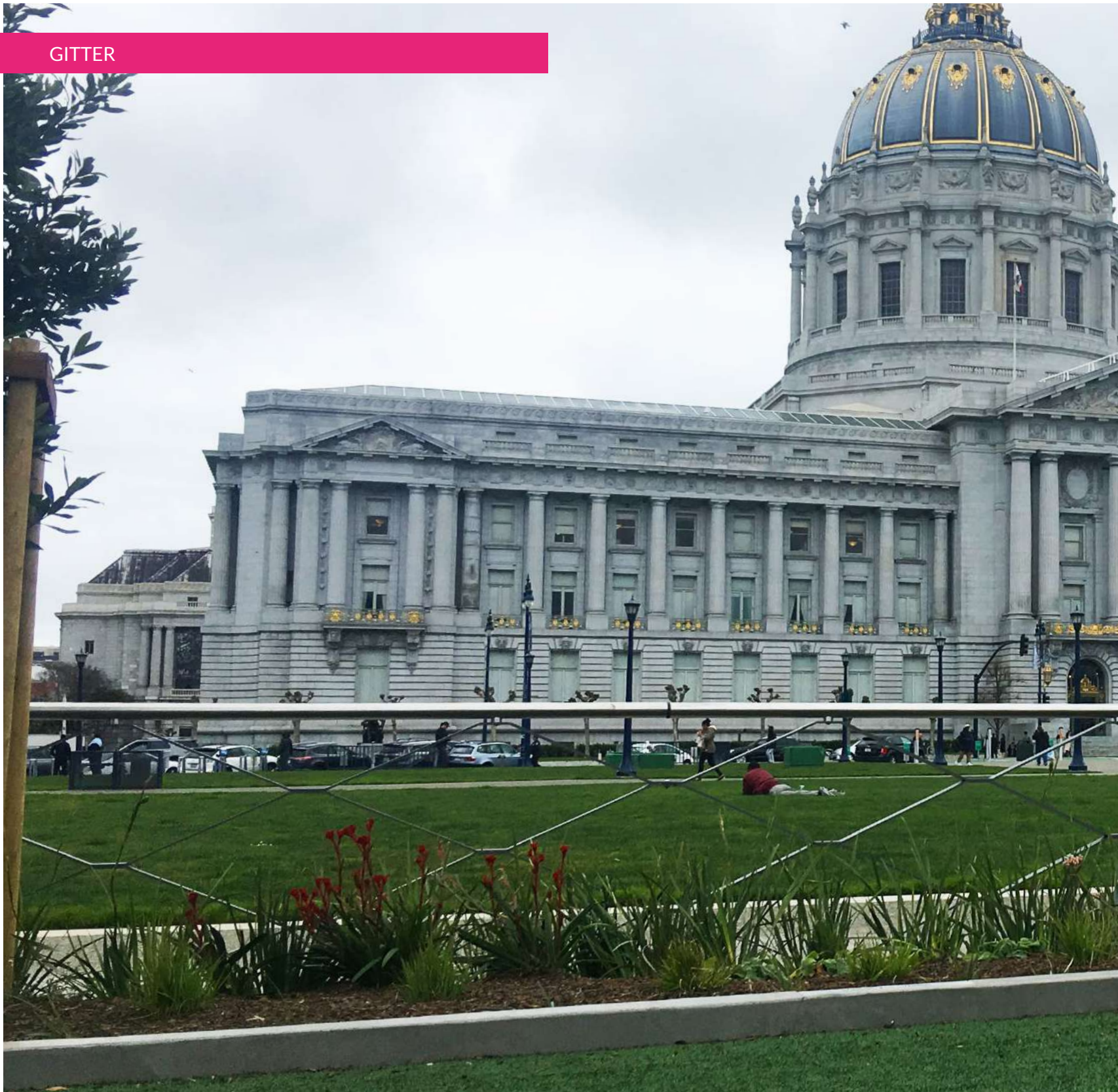









## GITTER

Designer:	Staubach & Kuckertz
Dimensions and weight Dimensiones y peso:	1376x1028 mm (+ 240 mm) base 35 kg
	2626x1028 mm (+ 240 mm) base 61 kg
	1250x1028 mm (+ 240 mm) comp. 25 kg
	2500x1028 (+ 240 mm) comp. 50 kg
Materials/Materiales:	Powder coated steel or Corten steel or Stainless steel Acero pintado o Acero Corten o Acero Inox
Fixing/Fijación:	Below ground installation Cimentación

Modular barrier composed of a panel made of steel plates with diamond pattern and a stainless steel tubes handrail. Two modules are available: base (to start/finish) and a composition.

Barrera modular constituida de un panel formado con motivos a rombo en plancha de acero y de un pasamanos en tubo de acero Inoxidable. Disponibles en dos tamaños: Base (inicio y fin) y composición.

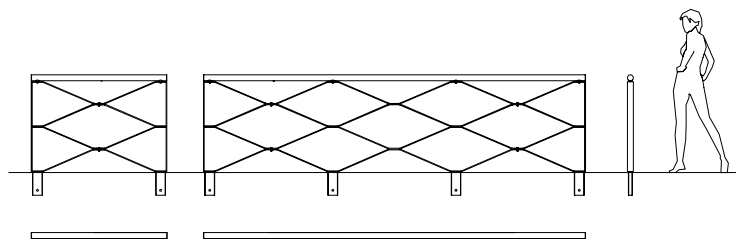



Inclined square base pedestrian bollard made of steel sheet with grooves on both sides.

Bolardo peatonal con base cuadrada con desarrollo vertical inclinado, realizado en chapa de acero con dos ranuras a los lados.

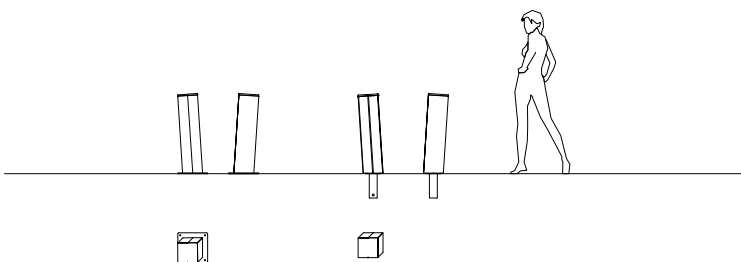

## HESPERIA

Designer:	Piero Mezzapelle
Dimensions and weight Dimensiones y peso:	200x200 mm H 800 mm (+ 250 mm) 15 kg
Materials/Materiales:	Powder coated steel or Corten steel Acero pintado o Acero Corten
Fixing/Fijación:	Pre-drilled for anchors or Below ground installation Predisposición para tacos o Cimentación



HOLLOW





Collection of pedestrian bollards composed of a perimeter in UHPC (Ultra High Performance Concrete). Three sizes are available, with or without LED lighting.

Colección de bolidos peatonales compuestos de un perímetro en UHPC (Ultra High Performance Concrete), disponibles en tres tamaños con y sin iluminación LED.

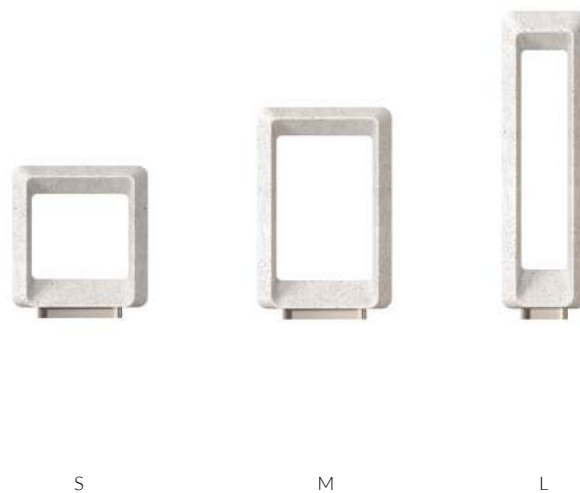
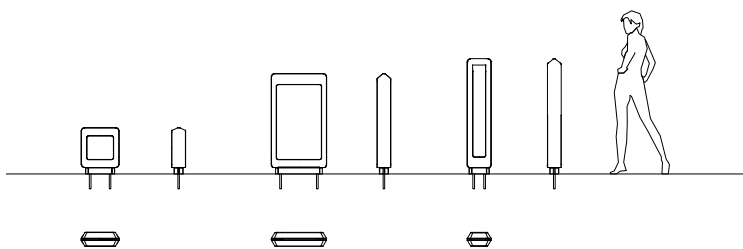

S

M

L

## HOLLOW

Designer:	Indio Da Costa AUDT	
Dimensions and weight Dimensiones y peso:	HOLLOW S 385x140 mm H 470 mm	22 kg
	HOLLOW M 560x140 mm H 1110 mm	40 kg
	HOLLOW L 240x140 mm H 1060 mm	35 kg
Materials/Materiales:	UHPC (Ultra High Performance Concrete)	
Finishes/Acabados:	Alfa - Natural smooth Alfa - Liso natural	
Fixing/Fijación:	Installation with threaded bars Cimentación con varillas roscadas	
Accessories/Accesorios:	LED lighting Iluminación LED	



T1





L 1500



L 3000

Collection of pedestrian bollards composed of truncated-conical bases in PDM (Reconstituted Stones) and stainless steel cross bars. Two versions are available: one with a single bar 1500 mm, that can be 90° rotated, and equipped with lock and the other with double base and a fixed bar 3000 mm.

Colección de bolardos peatonales, compuestos de bases con forma troncocónica en PDM (Piedras Reconstituidas) y de barras transversales en acero Inoxidable. Disponible en dos versiones: una con una base y una barra de 1500 mm de longitud giratoria de 90° con cerradura y la otra con doble base y una barra fija de 3000 mm de longitud.

## TI

Design:	Alfredo Tasca	
Dimensions and weight Dimensiones y peso:	1500x400 mm H 890 mm	146 kg
	3000x400 mm H 890 mm	292 kg
Materials/Materiales:	PDM (Reconstituted Stones) + Stainless steel PDM (Piedras Reconstituidas) + Acero Inox	
Finishes/Acabados:	PDM Sandblasted PDM Tratado con chorro de arena	
Fixing/Fijación:	Freestanding or Installation with threaded bars Apoyo o Cimentación con varillas roscadas	

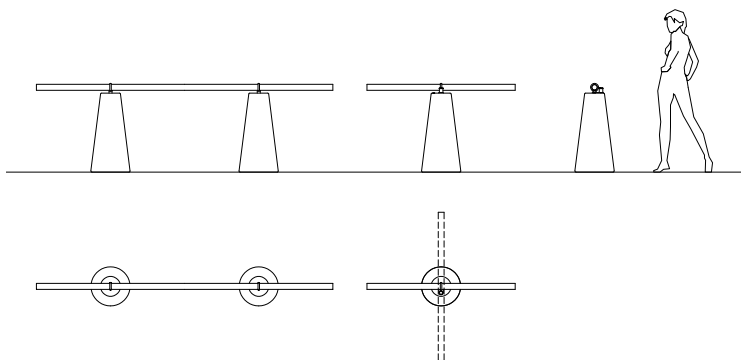





## MASCHERA

Designer:	Massimo Tasca
Dimensions and weight Dimensiones y peso:	1420x150 mm H 1430 mm (+200 mm) 50   7 kg
Materials/Materiales:	Powder coated steel or Corten steel Acero pintado o Acero Corten
Fixing/Fijación:	Pre-drilled for anchors or Below ground installation Predisposición para tacos o Cimentación

Modular system in steel composed of panels in laser perforated sheet metal with decoration, supported by poles made of steel plate.

Sistema modular en acero constituido de paneles en chapa perforada en láser con decoración y apoyados en pilares realizados en plancha.

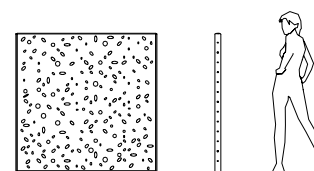



Steel pedestrian bollard equipped with a tapered support base.

Bolardo peatonal de acero equipado con un elemento cónico que actúa como base de apoyo.

## PENCIL

Designer:	Staubach & Kuckertz
Dimensions and weight Dimensiones y peso:	Ø 80 mm H 1000 mm (+ 200 mm) 8 kg
Materials/Materiales:	Powder coated steel Acero pintado
Fixing/Fijación:	Below ground installation Cimentación

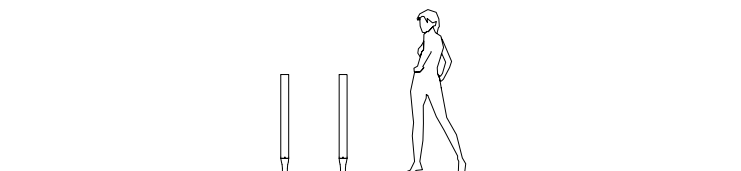

o



MOKA





METALCO

BOLLARDS AND BARRIERS

Pedestrian bollard composed of two vertical steel plates joined together by horizontal plates.

Bolardo peatonal compuesto de dos planchas verticales en acero unidas por placas horizontales.

## MOKA

Designer:	Sjit
Dimensions and weight Dimensiones y peso:	80x80 mm H 1000 mm 16 kg
Materials/Materiales:	Powder coated steel or Corten steel or Stainless steel Acero pintado o Acero Corten o Acero Inox
Fixing/Fijación:	Pre-drilled for anchors or Below ground installation Predisposición para tacos o Cimentación

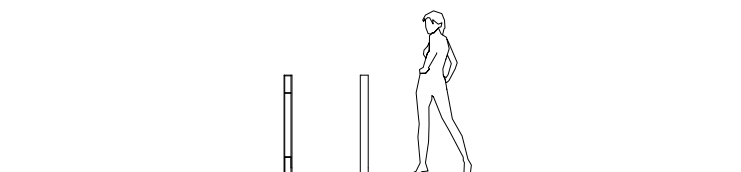

BOLLARDS Y VALLAS





Bollard made of steel tube composed of an oval-shaped element and a central support. It can also be used as a bike rack.

Bolardo en tubo de acero, con forma ovalada y con un soporte central. Se puede utilizar también como aparcabicicletas.

## OVAL

Designer:	<b>Alfredo Tasca</b>
Dimensions and weight Dimensiones y peso:	<b>260x150 mm H 850 mm (+ 200 mm) 6 kg</b>
Materials/Materiales:	<b>Powder coated steel Acero pintado</b>
Fixing/Fijación:	<b>Pre-drilled for anchors or Below ground installation Predisposición para tacos o Cimentación</b>

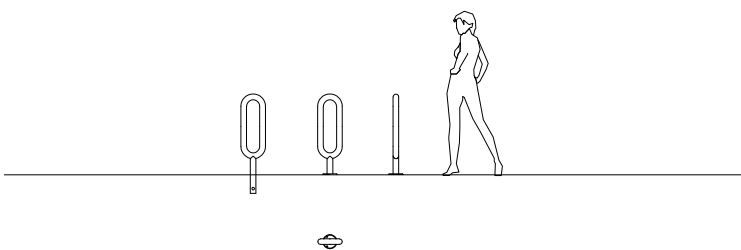



Collection of pedestrian bollards made of steel tube and available in the removable version equipped with a proper flat plate with laser cut for locking by lock.

Colección de bolardos peatonales en tubo de acero. Disponibles en versiones extraíbles dotados de la correspondiente placa plana con corte láser para permitir el bloqueo a través de una cerradura.

## QUICK

Designer:	Metalco Design
Dimensions and weight Dimensiones y peso:	Ø 102 mm H 1000 mm (+ 200 mm) 9   11 kg
Materials/Materiales:	Powder coated steel Acero pintado
Fixing/Fijación:	Pre-drilled for anchors or Below ground installation Predisposición para tacos o Cimentación

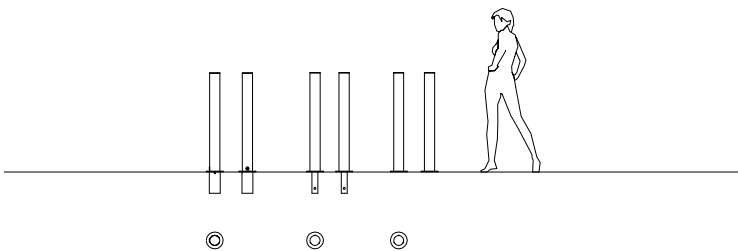





Pedestrian bollard made of cast aluminum and equipped with internal steel coupling.

Bolardo peatonal fabricado en fundición de aluminio y equipado con acoplamiento interno de acero.

## SIGARO

Designer:	Alfredo Tasca
Dimensions and weight Dimensiones y peso:	<p>Ø 94 mm max Ø 150 mm base H 850 mm (+ 150 mm)</p> <p style="text-align: right;">10 kg</p>
Materials/Materiales:	<p>Powder coated aluminum Aluminio pintado</p>
Fixing/Fijación:	<p>Pre-drilled for anchors or Below ground installation Predisposición para tacos o Cimentación</p>

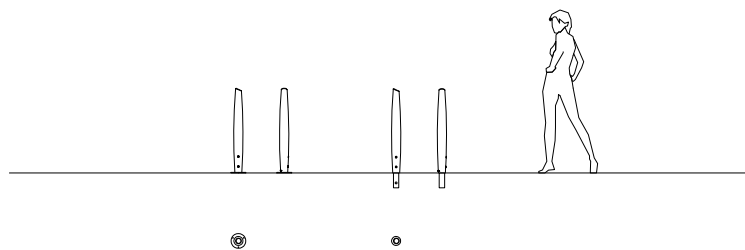



DIVIDIT







Modular system composed of an aluminum frame equipped with inclined currents, supported by two steel poles and by a rectangular steel planter.

Sistema modular formada por una estructura en aluminio con pasamanos inclinados, sujetos por dos elementos de soporte verticales en acero y de una jardinera de forma rectangular, esta también en acero.

## DIVIDIT

Designer:	Massimo Tasca	
Dimensions and weight Dimensiones y peso:	1200x80 mm H 1630 mm	30 kg
	1200x375 mm H 1630 mm	55 kg
Materials/Materiales:	Powder coated steel + Powder coated aluminum Acero pintado + Aluminio pintado	
Fixing/Fijación:	Pre-drilled for anchors Predisposición para tacos	

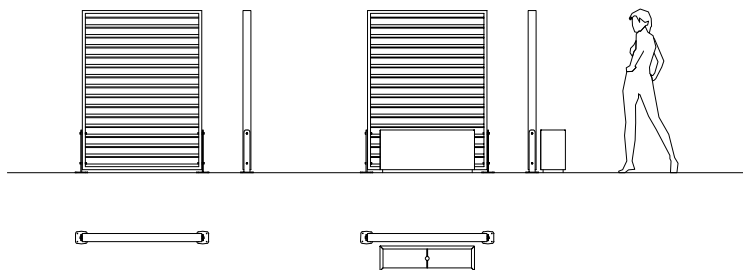

URBAN SCREEN







Modular steel system composed of a tube and laser perforated and decorated sheet metal panels and support base. Two sizes are available.

Sistema modular en acero constituido de un tubo e de paneles en chapa de acero perforada a laser con decoración y base de apoyo. Disponible en dos tamaños.

## URBAN SCREEN

Designer:	Uwe Kuckertz
Dimensions and weight Dimensiones y peso:	1600x140 mm H 1535 mm (+ 200 mm) 33 kg
	1400x140 mm H 1765 mm (+ 200 mm) 33 kg
Materials/Materiales:	Powder coated steel Acero pintado
Fixing/Fijación:	Pre-drilled for anchors or Below ground installation Predisposición para tacos o Cimentación

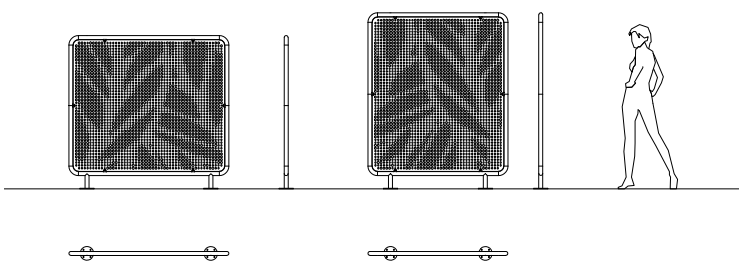



Collection of modular barriers composed of an external perimeter profile in steel plate and an internal tube in stainless steel. Two versions are available: with stainless steel wire ropes, arranged in three parallel rows (Verso P) or "X" shape (Verso X).

Colección de barreras modulares compuestas de un perfil perimetral externo, en plancha de acero y de un tubo interno en acero Inoxidable. Disponible en dos versiones dotados de cables en acero Inoxidable, dispuestos en tres filas paralelas (Versión P) o en "X" (Versión X).

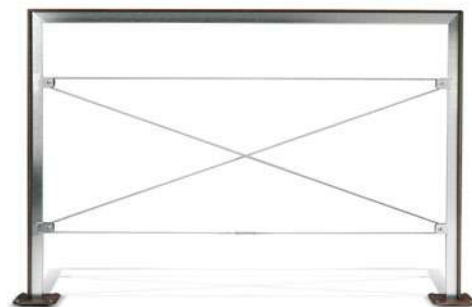
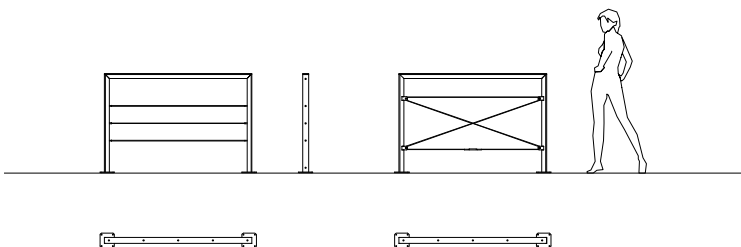

## VERSO P | X

Designer:	Alfredo Tasca
Dimensions and weight Dimensiones y peso:	1490x1000 mm (+ 200 mm) 21 kg
Materials/Materiales:	Powder coated steel or Corten steel + Stainless steel Acero pintado o Acero Corten + Acero Inox
Fixing/Fijación:	Pre-drilled for anchors or Below ground installation Predisposición para tacos o Cimentación



VISION

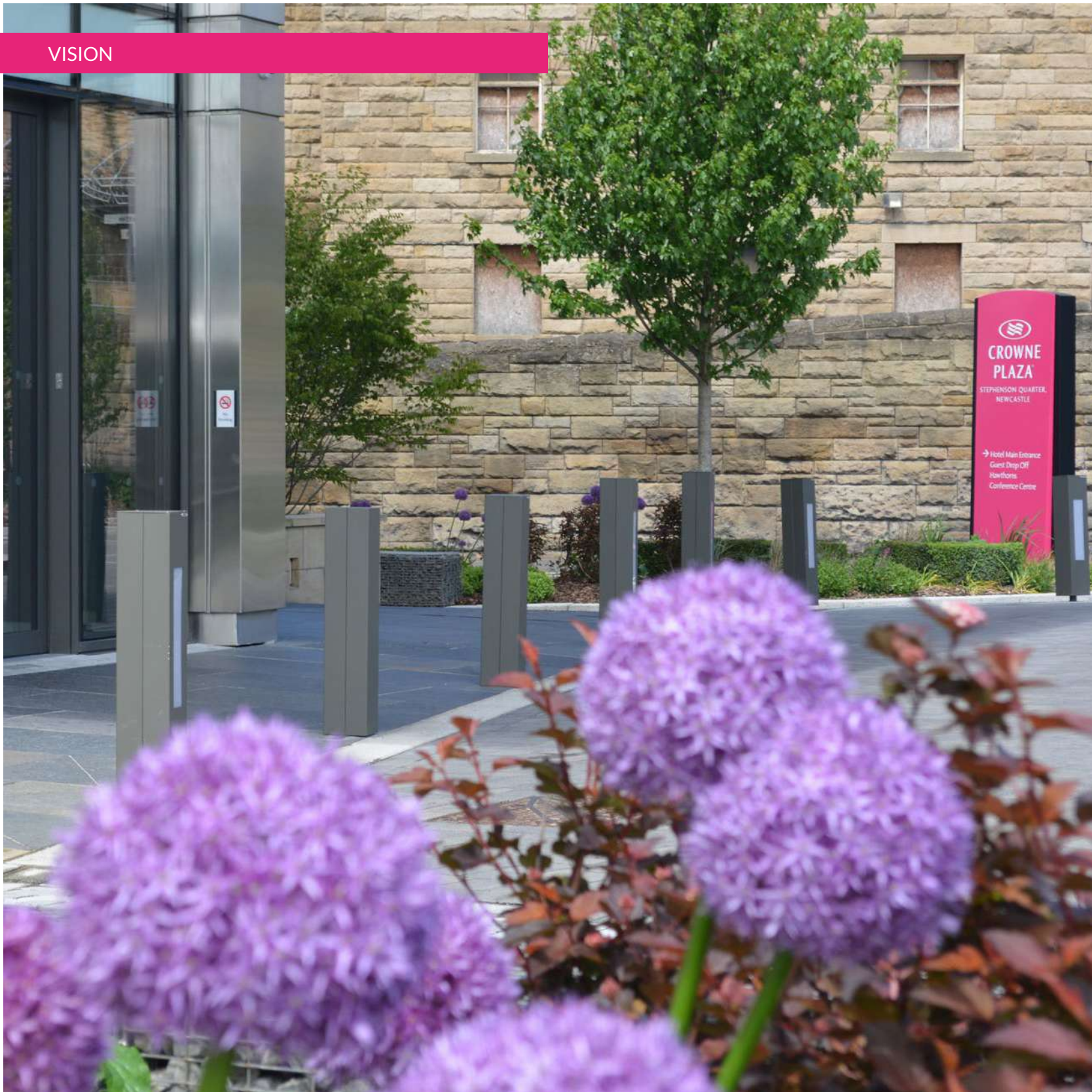





Collection of pedestrian bollards made of steel sheet. At the center of the structure a window made of opal polycarbonate sheets equipped with LED lighting is placed. Two sizes are available.

Colección de bolardos peatonales en chapa de acero. En el centro del cuerpo del bolardo consta una ventana rectangular dotada de placas de policarbonato compacto opalino e iluminación LED. Disponible en dos tamaños.

## VISION

Designer:	Sjit
Dimensions and weights Dimensiones y peso:	100x200 mm H 1000 mm (+ 250 mm) 15 kg  200x200 mm H 1000 mm (+ 250 mm) 21 kg
Materials/Material:	Powder coated steel or Corten steel or Stainless steel Acero pintado o Acero Corten o Acero Inox
Fixation/Fijación:	Pre-drilled for anchors or Below ground installation Predisposición para tacos o Cimentación

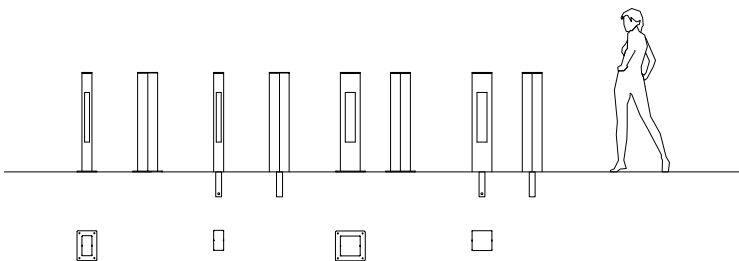





## WORD

Designer:	Sjit
Dimensions and weight Dimensiones y peso:	200x50 mm H 1000 mm (+ 220 mm) 13 kg  300x100 mm H 1000 mm (+ 220 mm) 20 kg
Materials/Materiales:	Powder coated steel or Corten steel or Stainless steel Acero pintado o Acero Corten o Acero Inox
Fixing/Fijación:	Pre-drilled for anchors or Below ground installation Predisposición para tacos o Cimentación

Collection of pedestrian bollards composed of a rectangular steel sheet base. At the center of the structure of the bollard a rectangular window is placed, that can be used for locking up bicycles. Two different sizes are available.

Colección de bolardos peatonales compuestos de una base rectangular en chapa de acero. En el centro del cuerpo del bolardo, consta una ventana rectangular que permite que pueda ser utilizado como aparcabicicletas.

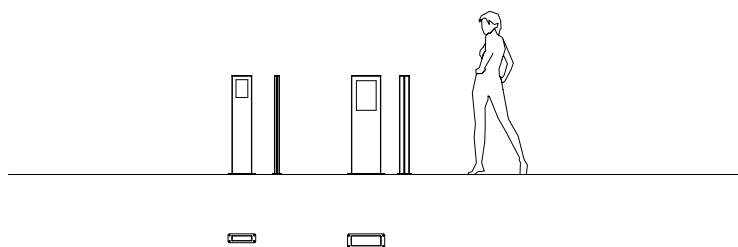



Collection of spherical pedestrian bollards with flat cap, made of PDM (Reconstituted Stones) and equipped with stainless steel support base. The sphere can be positioned in three different positions. Two versions of different diameters are available.

Colección de bolardos de forma esférica con casquete plano realizado en PDM (Piedra Reconstituidas) y dotado de una base de apoyo en acero Inoxidable. La esfera se puede posicionar en tres modos diferentes. Disponible en dos versiones con diferentes diámetros.

## ZAFFIRO

Designer:	Alfredo Tasca	
Dimensions and weight Dimensiones y peso:	Ø 500 mm	157 kg
	Ø 700 mm	420 kg
Materials/Materiales:	PDM (Reconstituted Stones) PDM (Piedras Reconstituidas)	
Finishes/Acabados:	Brushed seat + Sandblasted sides Parte superior trabajada con púas rígidas + Laterales tratados con chorro de arena	
Fixing/Fijación:	Installation with threaded bars Cimentación con varillas roscadas	

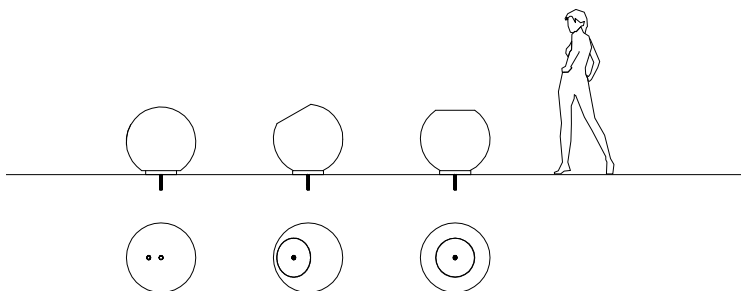
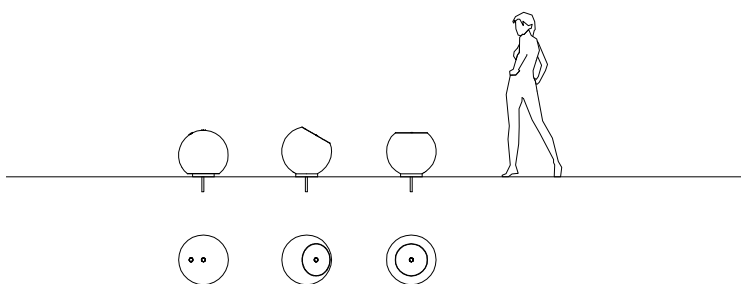



ALFREDO TASCA  
MASSIMO TASCA  
ANTONIO CITTERIO CON TOAN NGUYEN  
ALESSANDRO LENARDA  
PAMIO DESIGN  
STAUBACK & KUCKERTZ  
AUREL DESIGN URBAIN  
RAFFAELE LAZZARI  
MATTIA LI POMI  
METALCO DESIGN  
SJIT

---



# PLANTERS AND PLANT PROTECTORS: PERSPECTIVES OF GREENERY IN THE CITY

Jardineras y alcorques:  
perspectivas de “verde”  
en la ciudad







ALFA | BETA | GAMMA





ALFA | BETA | GAMMA

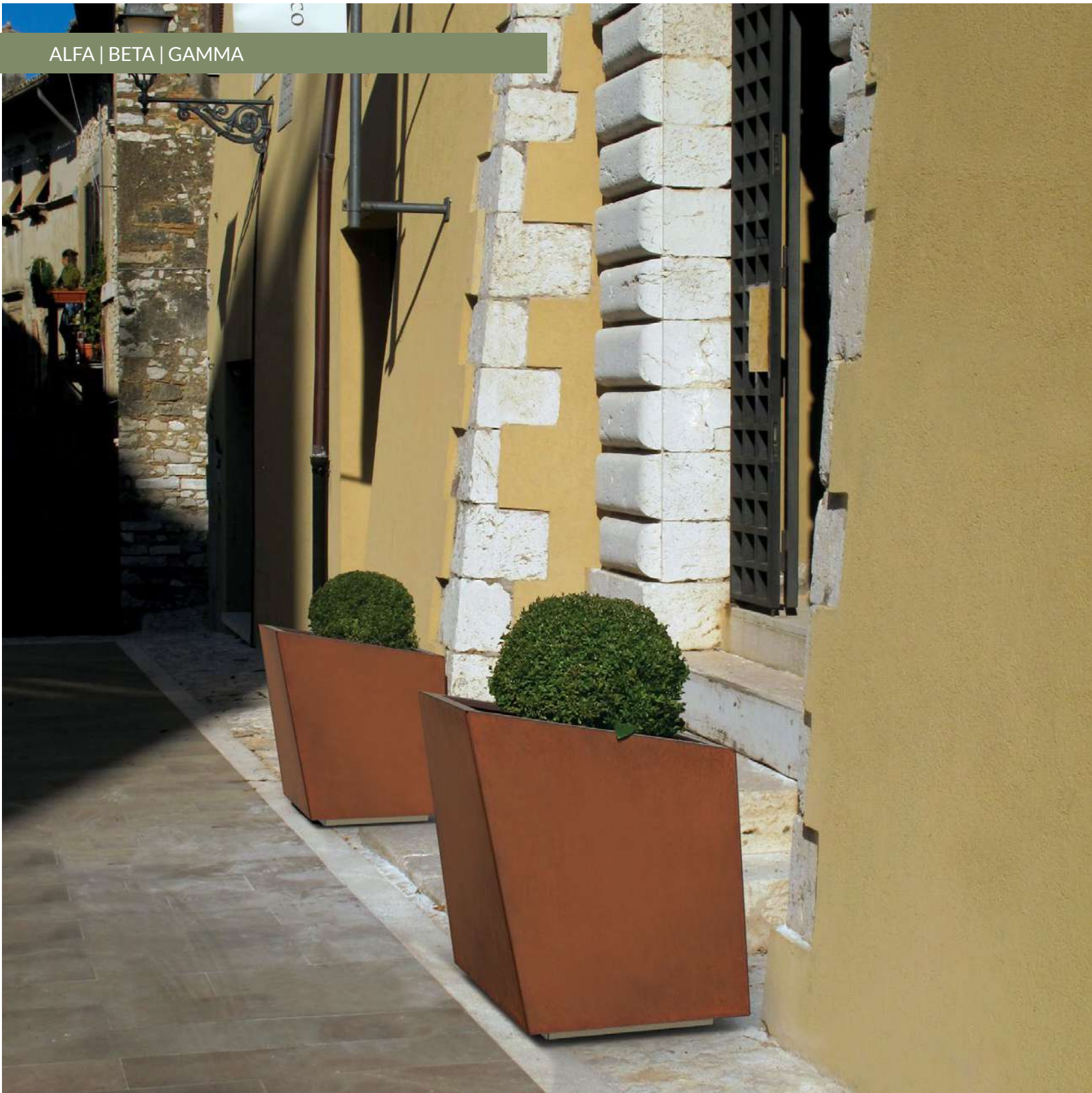



Modular collection of irregular shaped flower made of steel sheet and equipped with an adjustable support base. The different models can be combined to create linear or island compositions.

Colección de jardineras de forma irregular realizadas en chapa de acero y dotadas de una base de apoyo regulable. La colección es modular y permite la combinación de los diferentes modelos, formando composiciones lineares y a isla.

## ALFA | BETA | GAMMA

Designer:	Raffaele Lazzari	
Dimensions and weight Dimensiones y peso:	ALFA 615x700x680 mm	44 kg
	BETA 800x700x680 mm	52 kg
	GAMMA 1215x700x680 mm	75 kg
Materials/Materiales:	Powder coated steel or Stainless steel or Corten steel Acero pintado o Acero Inox o Acero Corten	
Fixing/Fijación:	Freestanding Apoyo	
Accessories/Accesorios:	Stainless steel plate Placa en acero Inox	

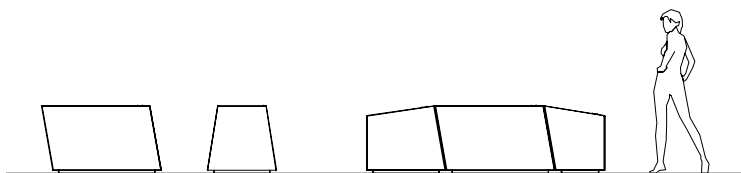
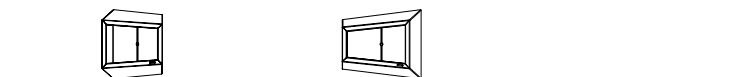
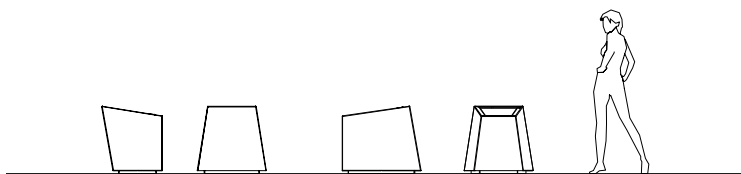





## ASTER

Designer:	Metalco Design
Dimensions and weight Dimensiones y peso:	Ø 550 mm H 1430 mm 48 kg
	Ø 950 mm H 980 mm 80 kg
	Ø 750 mm H 730 mm 50 kg
	Ø 1200 mm H 580 mm 76 kg
	Ø 950 mm H 580 mm 57 kg
	Ø 550 mm H 580 mm 30 kg
Materials/Materiales:	Powder coated steel or Stainless steel or Corten steel Acero pintado o Acero Inox o Acero Corten
Fixing/Fijación:	Freestanding Apoyo
Accessories/Accesorios:	Stainless steel plate Placa en acero Inox

Cylindrical planters made of steel sheet, with adjustable support base. Different sizes are available.

Jardinera de forma cilíndrica realizada en chapa de acero y con base de apoyo regulable. Disponible en varios tamaños.

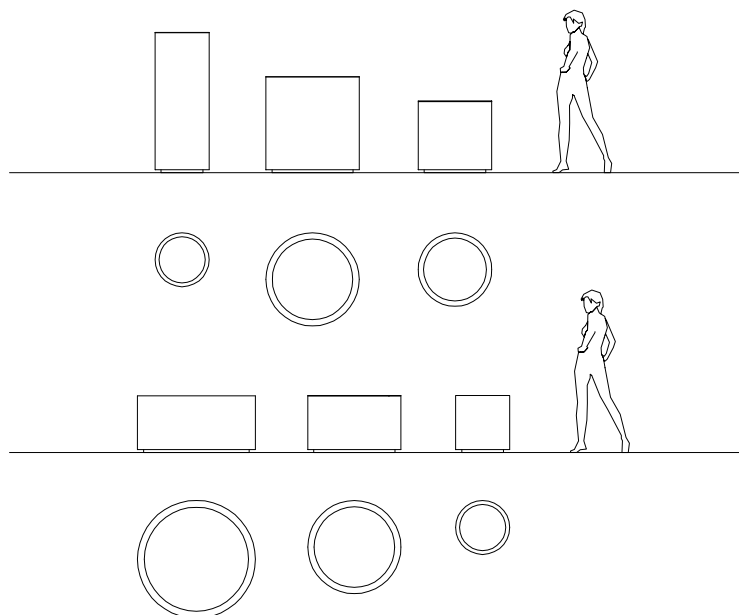



Rectangular planters made of steel sheet with adjustable support base. Two different sizes are available.

Jardinera de forma rectangular realizada en chapa de acero con base de apoyo regulable. Disponible en dos tamaños diferentes.

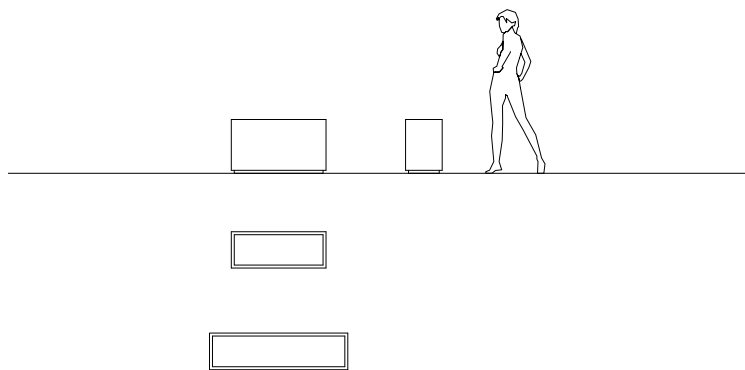

## BAMBÙ

Designer:	Metalco Design
Dimensions and weight Dimensiones y peso:	1400x370 mm H 545 mm 50 kg
	960x370 mm H 545 mm 37 kg
Materials/Materiales:	Powder coated steel or Stainless steel or Corten steel Acero pintado o Acero Inox o Acero Corten
Fixing/Fijación:	Freestanding Apoyo
Accessories/Accesorios:	Stainless steel plate Placa en acero Inox



BALL







Collection of semi-spherical planters made of PDM (Reconstituted Stones) with a slight recess at the base. Two sizes are available.

Colección de jardineras con forma semiesférica realizadas en PDM (Piedras Reconstituidas) dotadas de un ligero rebajo en la base. Disponible en dos tamaños.

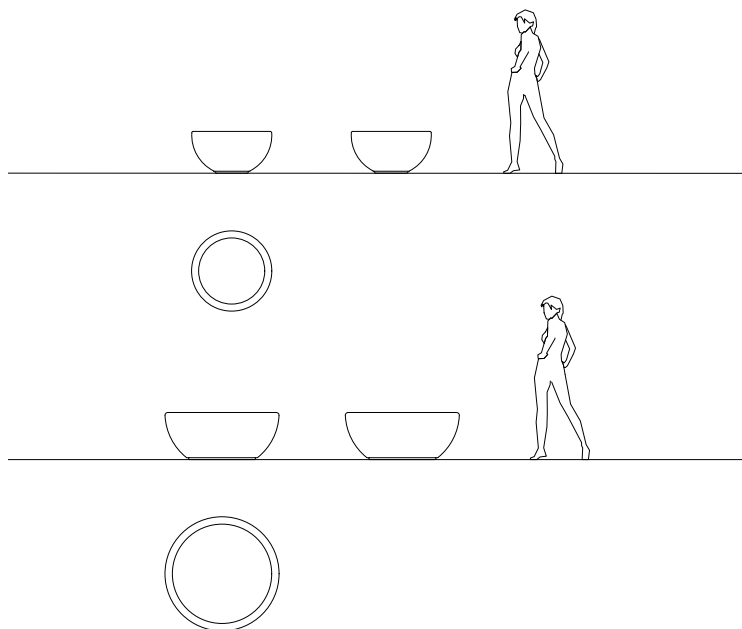

## BALL

Designer:	Metalco Department
Dimensions and weight Dimensiones y peso:	<p><b>BALL 800</b> Ø 800 mm H 415 mm 180 kg</p> <p><b>BALL 1150</b> Ø 1150 mm H 475 mm 450 kg</p>
Materials/Materiales:	PDM (Reconstituted Stones) PDM (Piedras Reconstituidas)
Finishes/Acabados:	Sandblasted Tratado con chorro de arena
Fixing/Fijación:	Freestanding Apoyo





## BALZAC W

Designer:	Pamio Design
Dimensions and weight Dimensiones y peso:	Ø 1500 mm H 490 mm (with seat - avec asiento) 650 kg
Materials/Materiales:	PDM (Reconstituted Stones) + Hardwood PDM (Piedras Reconstituidas) + Madera dura
Finishes/Acabados:	Sandblasted, Brushed top Trabajado con chorro de arena, Parte superior trabajado con púas rígidas
Fixing/Fijación:	Freestanding or Installation with threaded bar Apoyo o Cimentación con varillas roscadas

Collection of planters shaped as inverted bell made of PDM (Reconstituted Stones) equipped with an adjustable support base. Three versions that differ for height are available. The 450 mm version can be accessorized with wooden seat.

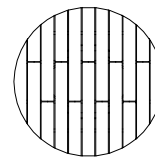
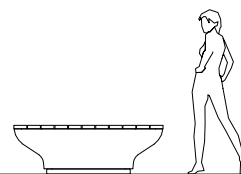



Colección de jardineras en forma de campana invertida realizadas en PDM (Piedras Reconstituidas) y dotadas de base de apoyo regulable. Disponible en tres versiones diferentes por altura. A la versión de 450 mm se le puede añadir el asiento de madera.

## BALZAC F

Designer:	Pamio Design	
Dimensions and weight Dimensiones y peso:	Ø 1500 mm H 450 mm	560 kg
	Ø 1500 mm H 950 mm	770 kg
	Ø 1500 mm H 1350 mm	906 kg
Materials/Materiales:	PDM (Reconstituted Stones) PDM (Piedras Reconstituidas)	
Finishes/Acabados:	Sandblasted, Brushed top Trabajado con chorro de arena, Parte superior trabajado con púas rígidas	
Fixing/Fijación:	Freestanding or Installation with threaded bar Apoyo o Cimentación con varillas roscadas	

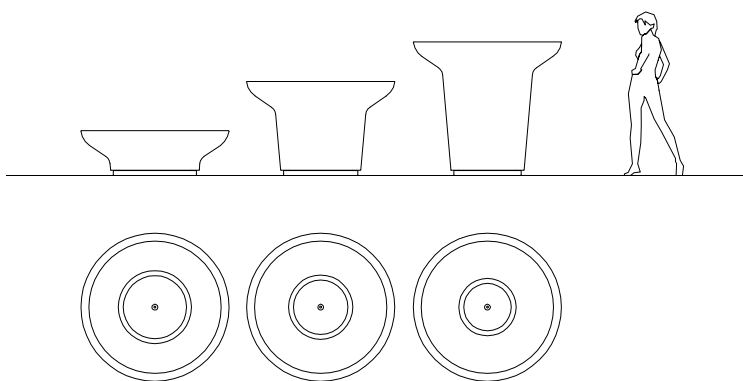





## DAHLIA

Designer:	Metalco Design	
Dimensions and weight Dimensiones y peso:	L 550 mm H 1430 mm	73 kg
	L 950 mm H 980 mm	119 kg
	L 745 mm H 680 mm	60 kg
	L 1200 mm H 580 mm	104 kg
	L 950 mm H 580 mm	83 kg
	L 550 mm H 580 mm	31 kg
Materials/Materiales:	Powder coated steel or Stainless steel or Corten steel Acero pintado o Acero Inox o Acero Corten	
Fixing/Fijación:	Freestanding Apoyo	
Accessories/Accesorios:	Stainless steel plate Placa en acero Inox	

Cubic planters made of steel sheet, with adjustable support base. Different sizes are available.

Jardinera de forma cúbica realizada en chapa de acero con base de apoyo regulable en función del terreno. Disponible en varios tamaños.

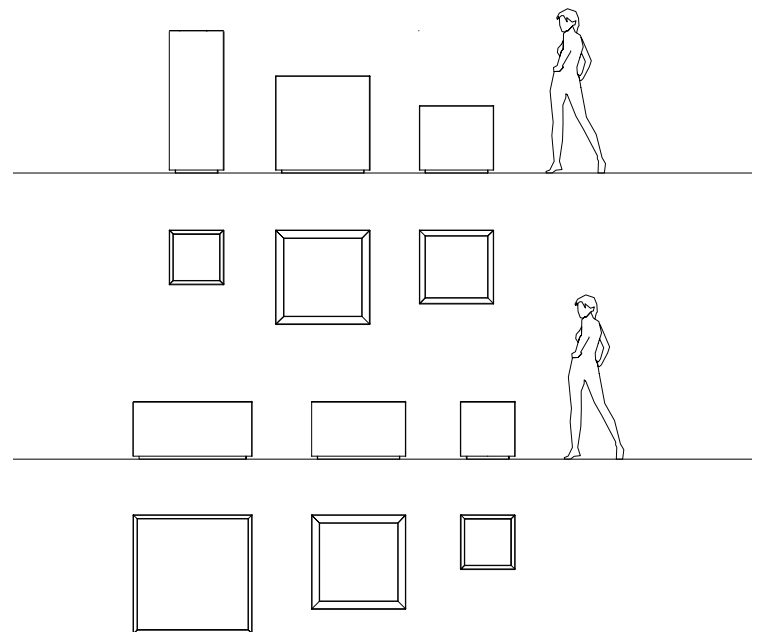



Circular planters composed of a supporting structure, a three-point levelling base and an upper steel ring with perimeter covering made of cast aluminium elements, which create a ventilated cavity, improving the microclimate of the soil.

Jardinera de forma circular compuesta de: una estructura portante, una base nivelable en tres puntos y un aro de acero en la parte superior con revestimiento perimetral compuesto de elementos en fundición de aluminio, que crean, de hecho, una cámara aislante mejorando el microclima del terreno.

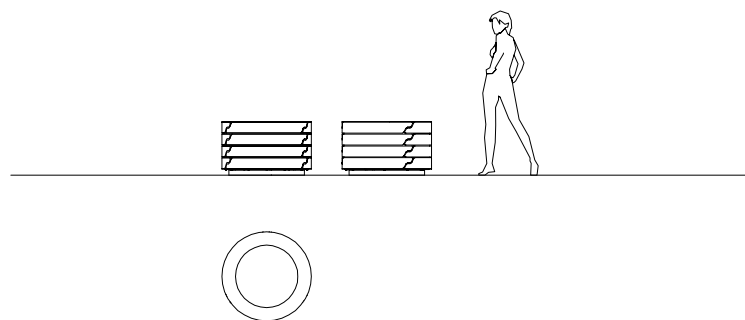

## FLORES

Designer:	Antonio Citterio con Toan Nguyen	
Dimensions and weight Dimensiones y peso:	Ø 900 mm H 420 mm	64 kg
	Ø 900 mm H 540 mm	71 kg
	Ø 900 mm H 660 mm	78 kg
Materials/Materiales:	Powder coated aluminum + Powder coated steel Aluminio pintado + Acero pintado	
Fixing/Fijación:	Freestanding Apoyo	



FLÒ





Modular system of planters made of steel sheet equipped with a perimeter frame in steel plate, that acts as an adjustable support base. The modular collection allows to combine the different elements, available in two versions, one concave and the other convex, and in two different heights. The elements can be accessorized with wooden bench.

Sistema componible de jardineras realizadas en chapa de acero dotadas de un marco perimetral en plancha de acero, que sirve de base de apoyo y es regulable. La colección es modular y permite combinar los diferentes elementos entre ellos. Existen dos versiones, una cóncava y otra convexa y dos alturas diferentes. A los elementos se les puede añadir el asiento de madera.

## FLÒ

Designer:	Alessandro Lenarda	
Dimensions and weight	1060x1500 mm H 550 mm	85 kg
Dimensiones y peso:	1060x1500 mm h 400 mm	71 kg
	439x1060 mm H 700 mm	42 kg
	439x1060 mm h 400 mm	28 kg

Materials/Materiales: Powder coated steel + Hardwood  
Acero pintado + Madera dura

Fixing/Fijación: Freestanding  
Apoyo

Accessories/Accesorios: Wooden bench  
Banco de madera

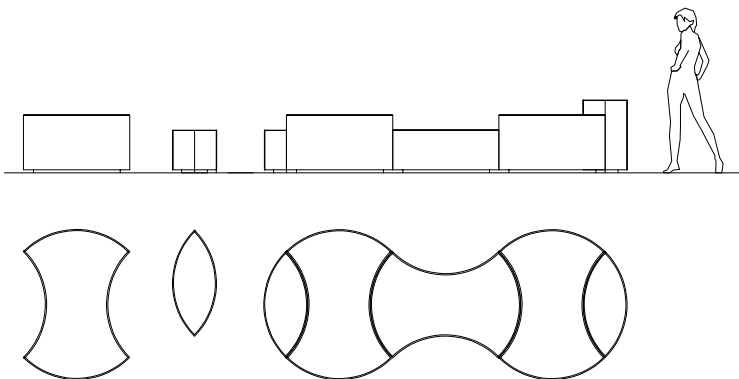





## LOUNGE

Designer:	<b>Metalco Design</b>	
Dimensions and weight Dimensiones y peso:	L 750 mm H 1230 mm	85 kg
	L 950 mm H 580 mm	41 kg
	L 950 mm H 330 mm	31 kg
Materials/Materiales:	Powder coated steel or Stainless steel or Corten steel Acero pintado o Acero Inox o Acero Corten	
Fixing/Fijación:	Freestanding Apoyo	
Accessories/Accesorios:	Stainless steel plate Placa en acero Inox	

Truncated pyramid shaped planters made of steel sheet with adjustable support base. Different sizes are available.

Jardinera con forma tronco piramidal realizada en chapa de acero con base de apoyo regulable. Disponible en varios tamaños.

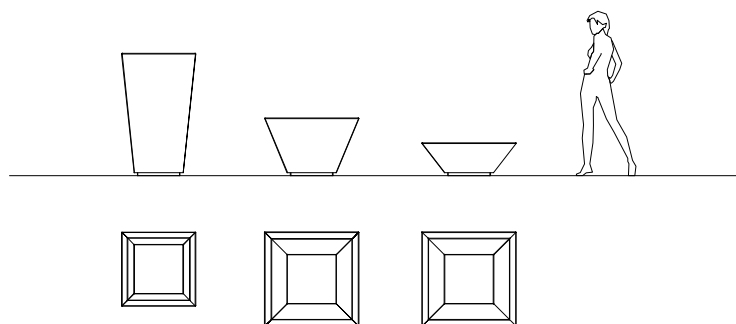



Truncated-conical planters made of steel sheet, with adjustable support base. Different sizes are available.

Jardinera con forma troncocónica realizada en chapa de acero con base de apoyo regulable respecto al terreno. Disponible en varios tamaños.

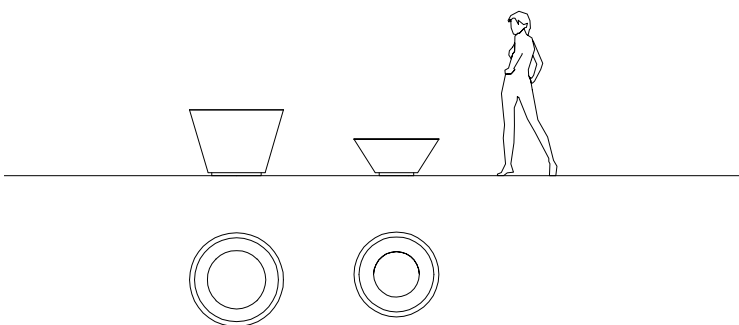

## PITOCCA

Designer:	Sjit	
Dimensions and weight Dimensiones y peso:	Ø 946 mm H 665 mm	37 kg
	Ø 855 mm H 370 mm	23 kg
Materials/Materiales:	Powder coated steel or Stainless steel or Corten steel Acero pintado o Acero Inox o Acero Corten	
Fixing/Fijación:	Freestanding Apoyo	



ONICE

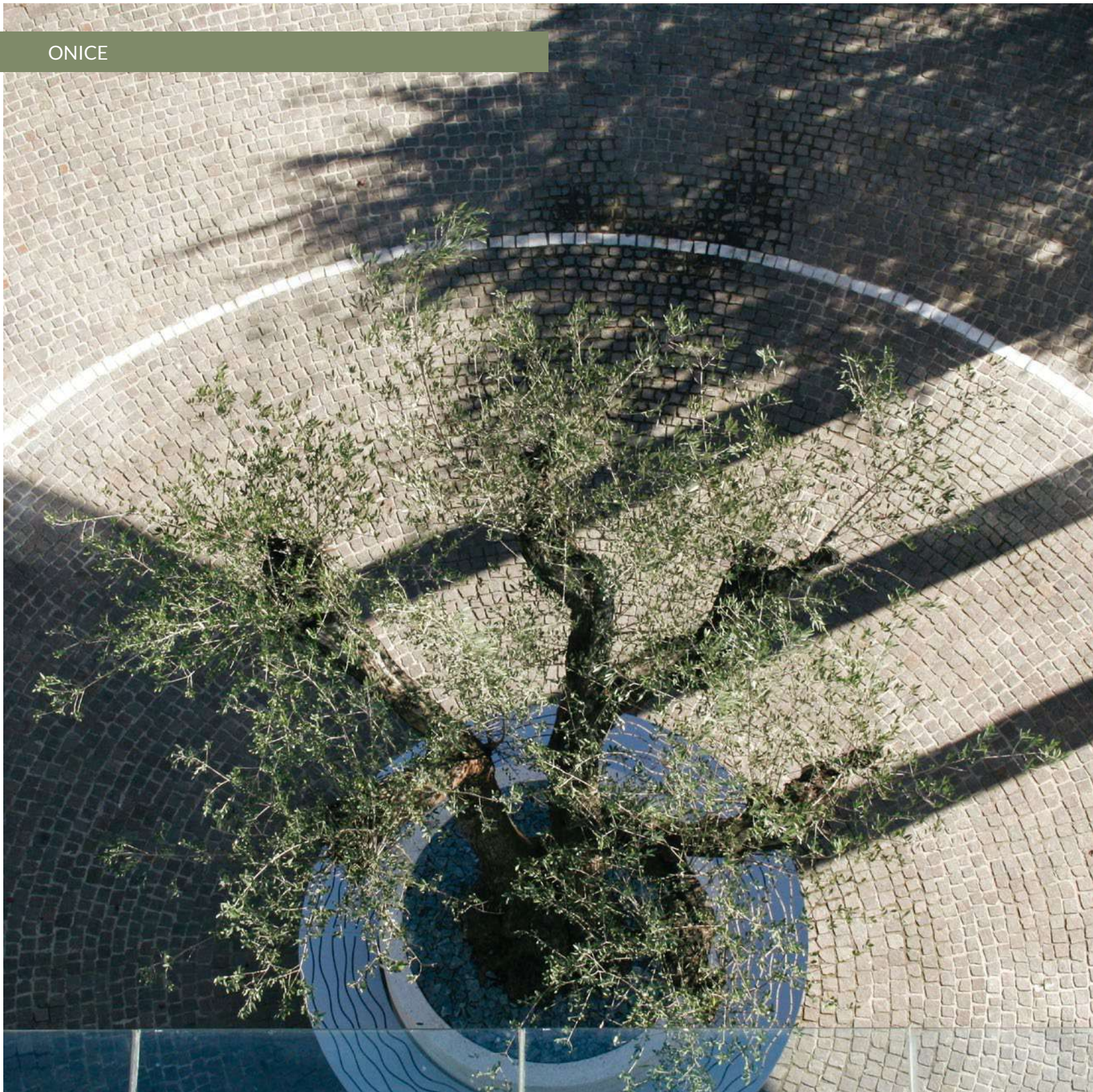





Circular planters made of PDM (Reconstituted Stones), decorated with horizontal milling and equipped with a slight recess at the base. Three sizes are available. The versions Ø 1200 mm and Ø 1500 mm can be accessorized with a circular seat made of decorated steel sheet.

Jardinera de forma circular realizada en PDM (Piedras Reconstituídas) decorada con fresado horizontal y dotada de un rebajo en la base. Disponible en 3 tamaños. A las versiones con Ø 1200 mm y con Ø 1500 mm se les puede añadir el asiento de madera.

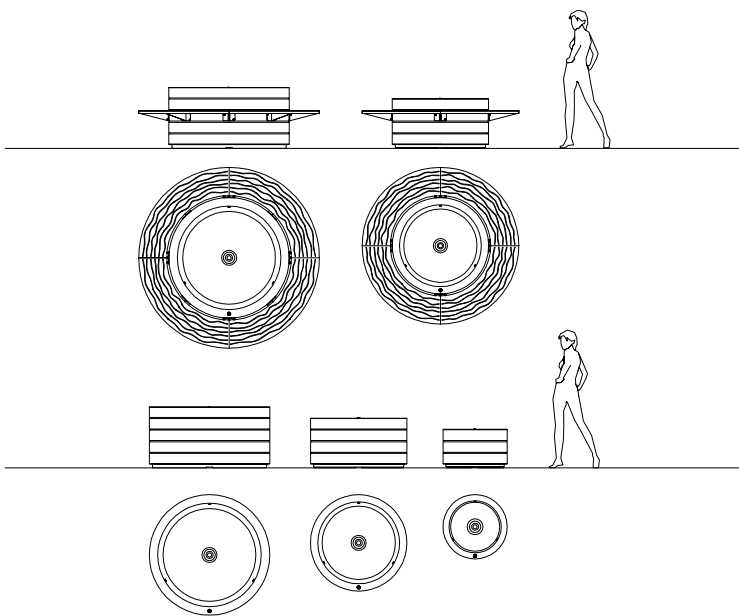

## ONICE

Designer:	Staubach & Kuckertz	
Dimensions and weight Dimensiones y peso:	Ø 800 mm H 480 mm	278 kg
	Ø 1200 mm H 620 mm	753 kg
	Ø 1500 mm H 760 mm	1361 kg
Materials/Materiales:	PDM (Reconstituted Stones) + Powder coated steel PDM (Piedras Reconstituídas) + Acero pintado	
Finishes/Acabados:	PDM Sandblasted PDM Tratado con chorro de arena	
Fixing/Fijación:	Freestanding Apoyo	
Accessories/Accesorios:	Steel sheet bench in (Ø 1200   Ø 1500 mm) Banco en lámina de acero (Ø 1200   Ø 1500 mm)	



PARABEL L









PARABEL S

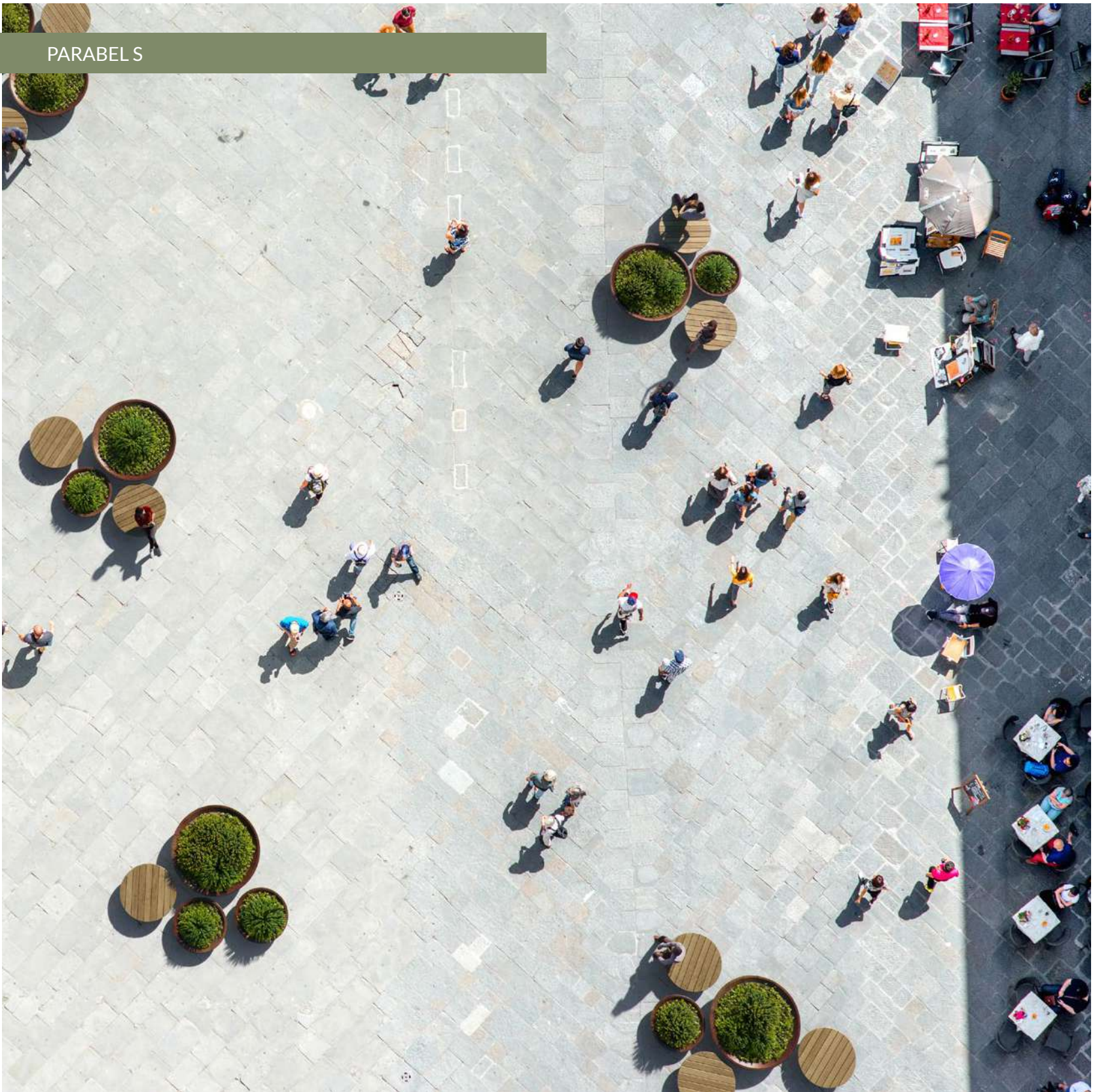





Collection of semi-spherical planters made of steel sheet with central crossed reinforcements as bases. Two sizes are available. The S model can be completely used as a seat thanks to the proper accessory (SW) in wood or in WPC (Wood Polymer Composite).

Colección de jardineras semiesféricas fabricadas en chapa de acero, con refuerzos cruzados centrales que hacen de base. Disponible en dos medidas. El modelo S se puede adaptar completamente, convirtiéndose en asiento gracias al accesorio (SW) de madera o WPC (Wood Polymer Composites).

## PARABEL S

Designer:	Massimo Tasca	
Dimensions and weight Dimensiones y peso:	Ø 1220 mm H 355 mm	40 kg
	Ø 1230 mm H 400 mm	100 kg
Materials/Materiales:	Corten steel + Hardwood or WPC plus (Wood Polymer Composite) Acero Corten + Madera dura o WPC plus (Wood Polymer Composite)	
Fixing/Fijación:	Below ground installation Cimentación	
Accessories/Accesorios:	Wooden bench Banco de madera	

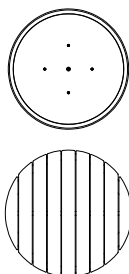
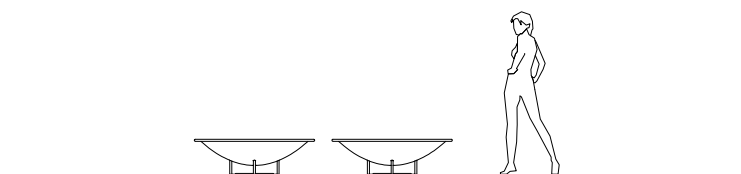



PARABEL L





Collection of semispherical planters made of steel sheet with with central crossed reinforcements as bases. Two sizes are available. The L planter can accommodate a multipurpose element (LW) in wood or WPC (Wood Polymer Composite) on the steel frame that can act as a seat, partially covering the planter.

Colección de jardineras semiesféricas fabricadas en chapa de acero, con refuerzos cruzados que forman la base. Disponible en dos tamaños. A la jardinera L se le puede añadir un elemento polivalente en madera o WPC (Wood Polymer Composites), sobre un marco de acero, que puede actuar como asiento cubriendo parcialmente la jardinera (LW).

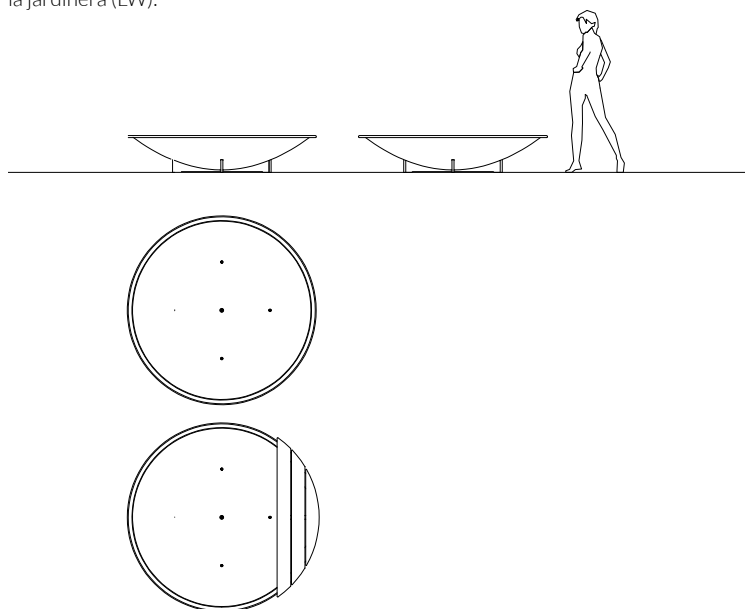

## PARABEL L

Designer:	Massimo Tasca	
Dimensions and weight Dimensiones y peso:	Ø 1920 mm H 375 mm	85 kg
	Ø 1950 mm H 420 mm	110 kg
Materials/Materiales:	Corten steel + Hardwood or WPC plus (Wood Polymer Composite) Acero Corten + Madera dura o WPC plus (Wood Polymer Composite)	
Fixing/Fijación:	Below ground installation Cimentación	
Accessories/Accesorios:	Wooden bench Banco de madera	



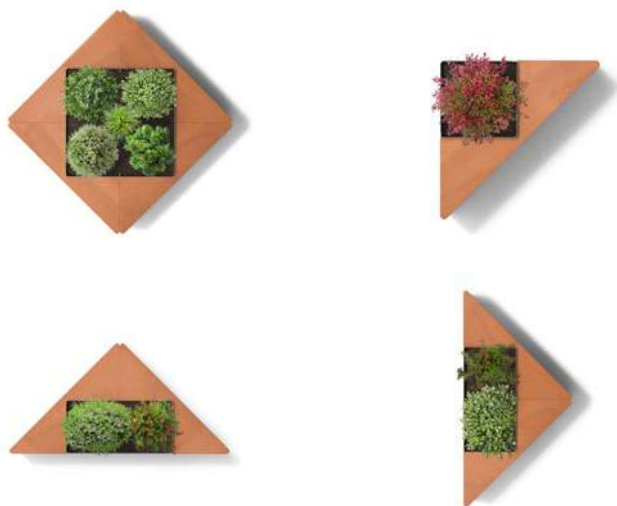

## TRIANGLE

Designer:	Staubach & Kuckertz
Dimensions and weight Dimensiones y peso:	2890x2891 mm H 490 mm h 460 mm 410 kg
	2890x1445 mm H 490 mm h 460 mm 130 kg
	1440x1445 mm H 490 mm h 460 mm 232 kg
Materials/Materiales:	Powder coated steel + Okume plywood Acero pintado + Contrachapado de Okumè
Fixing/Fijación:	Freestanding Apoyo

Modular system of planters made of steel and equipped with an integrated system of seats in Okumè plywood. Three versions are available: two triangular and one square, that differ for the size of the planter.

Sistema modular de jardineras realizadas en acero y dotada de un sistema integrado de asientos de madera multilaminada de Okumè. Las tres versiones disponibles, dos triangulares y una cuadrada, difieren por el tamaño de la maceta.

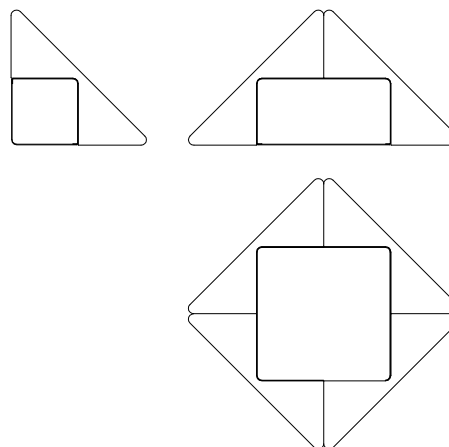
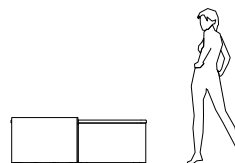



3XL

XXL

XL



Truncated-conical planters with decorative edge made of Corten steel sheet and equipped with a base for handling. Three different sizes are available.

Jardinera de forma troncocónica con reborde, realizada en chapa de acero Corten y dotada de una base para facilitar su desplazamiento. Disponible en tres tamaños diferentes.

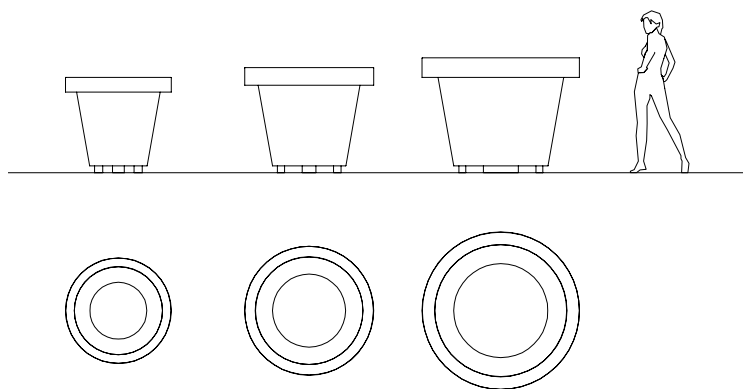

## SIZE

Designer:	Massimo Tasca	
Dimensions and weight Dimensiones y peso:	Ø 1080 mm H 973 mm	88 kg
	Ø 1320 mm H 1073 mm	122 kg
	Ø 1610 mm H 1173 mm	172 kg

Materials/Materiales: Corten steel  
Acero Corten

Fixing/Fijación: Freestanding  
Apoyo

Accessories/Accesorios: LED lighting system  
Iluminación LED



LITTERA



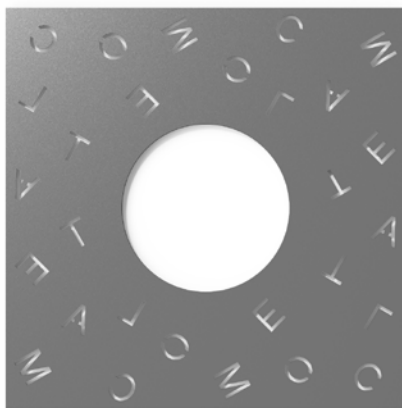

Square tree grille with a circular hole, made of steel sheet laser decorated with capital letters pattern. It is composed of two halves arranged for their fixing with screws and equipped with steel plate reinforcements, placed internally and on the perimeter. Several versions, that differ for size and/or hole diameter, are available. It can be accessorized with counter-frame.

Alcorque de forma cuadrada y con foro circular, realizado en chapa de acero, decorado realizado a laser con motivos con letras mayúsculas. Se compone de dos mitades predispuestas para que se fijen entre ellas con tornillos y están reforzadas con planchas de acero, puestas internamente y en el perímetro. Disponible en varias versiones por tamaño y/o diámetro del foro. Posibilidad de complementarla con un marco de acero galvanizado.

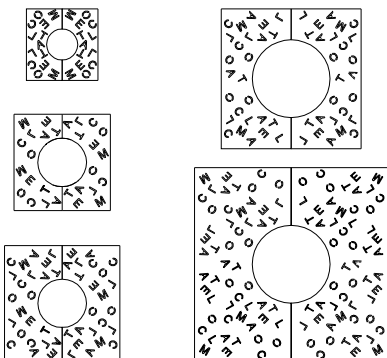

## LITTERA

Designer:	Raffaele Lazzari
Dimensions/Dimensiones:	<p>Ø 320 mm L 735 mm H 35 mm</p> <p>Ø 500 mm L 990 mm H 35 mm</p> <p>Ø 500 mm L 1190 mm H 35 mm</p> <p>Ø 800 mm L 1190 mm H 35 mm</p> <p>Ø 800 mm L 1440 mm H 35 mm</p> <p>Ø 800 mm L 1990 mm H 35 mm</p>
Materials/Materiales:	<p>Powder coated steel or Stainless steel or Corten steel</p> <p>Acero pintado o Acero Inox o Acero Corten</p>
Fixing/Fijación:	<p>Below ground installation + Freestanding</p> <p>Cimentación + Apoyo</p>
Accessories/Accesorios:	<p>Counter-frame in galvanized steel</p> <p>Marco en acero galvanizado</p> <p>Galvanized steel counter-frame</p> <p>Upon request 3.5 ton carriageable version</p> <p>Marco en acero galvanizado</p> <p>Bajo solicitud, version transitable de 3,5 T</p>



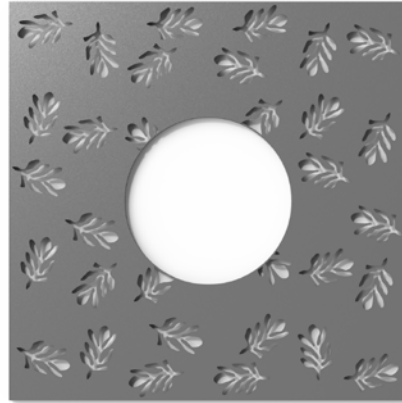

## FLORA

Designer:	Raffaele Lazzari
Dimensions/Dimensiones:	<p>Ø 320 mm L 735 mm H 35 mm</p> <p>Ø 500 mm L 990 mm H 35 mm</p> <p>Ø 500 mm L 1190 mm H 35 mm</p> <p>Ø 800 mm L 1190 mm H 35 mm</p> <p>Ø 800 mm L 1440 mm H 35 mm</p> <p>Ø 800 mm L 1990 mm H 35 mm</p>
Materials/Materiales:	<p>Powder coated steel or Stainless steel or Corten steel</p> <p>Acero pintado o Acero Inox o Acero Corten</p>
Fixing/Fijación:	<p>Below ground installation + Freestanding</p> <p>Cimentación + Apoyo</p>
Accessories/Accesorios:	<p>Counter-frame in galvanized steel</p> <p>Marco en acero galvanizado</p> <p>Galvanized steel counter-frame</p> <p>Upon request 3.5 ton carriageable version</p> <p>Marco en acero galvanizado</p> <p>Bajo solicitud, version transitable de 3,5 T</p>

Square tree grille with a circular hole, made of steel sheet laser decorated with floral pattern. It is composed of two halves arranged for their fixing with screws and equipped with steel plate reinforcements, placed internally and on the perimeter. Several versions are available, that differ for size and/or hole diameter. It can be accessorized with counter-frame.

Alcorque de forma cuadrada y con foro circular, realizado en chapa de acero, decorado realizado a laser con motivos florales. Se compone de dos mitades predispuestas para que se fijen entre ellas con tornillos y están reforzadas con planchas de acero, puestas internamente y en el perímetro. Disponible en varias versiones por tamaño y/o diámetro del foro. Posibilidad de complementarla con un marco de acero galvanizado.

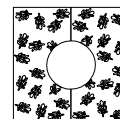
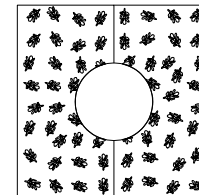
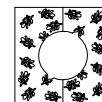
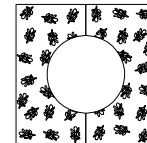

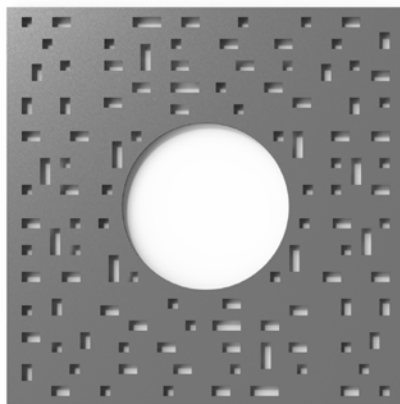

Square tree grille with a circular hole made of laser-decorated steel sheet, with ground-inspired pattern. It is composed of two halves arranged for fixing each other with screws and equipped with steel plate reinforcements, placed internally and on the perimeter. Several versions are available, that differ for size and/or hole diameter. It can be accessorized with counter-frame.

Alcorque de forma cuadrada y con foro circular, realizado en chapa de acero, decorado realizado a laser con motivos geométricos. Se compone de dos mitades predisuestas para que se fijen entre ellas con tornillos y están reforzadas con planchas de acero, puestas internamente y en el perímetro. Disponible en varias versiones por tamaño y/o diámetro del foro. Posibilidad de complementarla con un marco de acero galvanizado.

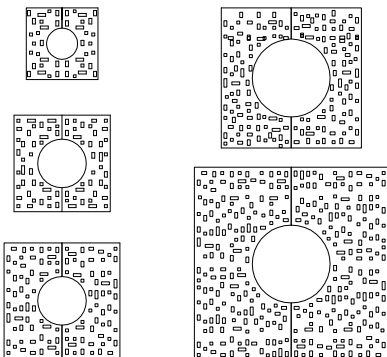

## STELO

Designer:	Raffaele Lazzari
Dimensions/Dimensiones:	<p>Ø 320 mm L 735 mm H 35 mm</p> <p>Ø 500 mm L 990 mm H 35 mm</p> <p>Ø 500 mm L 1190 mm H 35 mm</p> <p>Ø 800 mm L 1190 mm H 35 mm</p> <p>Ø 800 mm L 1440 mm H 35 mm</p> <p>Ø 800 mm L 1990 mm H 35 mm</p>
Materials/Materiales:	<p>Powder coated steel or Stainless steel or Corten steel</p> <p>Acero pintado o Acero Inox o Acero Corten</p>
Fixing/Fijación:	<p>Below ground installation + Freestanding</p> <p>Cimentación + Apoyo</p>
Accessories/Accesorios:	<p>Counter-frame in galvanized steel</p> <p>Marco en acero galvanizado</p> <p>Galvanized steel counter-frame</p> <p>Upon request 3.5 ton carriageable version</p> <p>Marco en acero galvanizado</p> <p>Bajo solicitud, version transitable de 3,5 T</p>



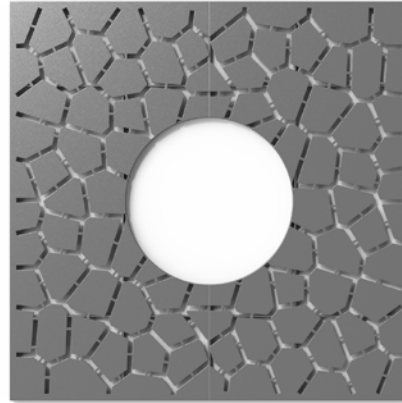

## LAND

Designer:	Alfredo Tasca
Dimensions/Dimensiones:	<p>Ø 500 mm L 990 mm H 35 mm</p> <p>Ø 500 mm L 1190 mm H 35 mm</p> <p>Ø 800 mm L 1190 mm H 35 mm</p> <p>Ø 800 mm L 1440 mm H 35 mm</p>
Materials/Materiales:	<p>Powder coated steel or Stainless steel or Corten steel</p> <p>Acero pintado o Acero Inox o Acero Corten</p>
Fixing/Fijación:	<p>Below ground installation + Freestanding</p> <p>Cimentación + Apoyo</p>
Accessories/Accesorios:	<p>Counter-frame in galvanized steel</p> <p>Marco en acero galvanizado</p> <p>Galvanized steel counter-frame</p> <p>Upon request 3.5 ton carriageable version</p> <p>Marco en acero galvanizado</p> <p>Bajo solicitud, version transitable de 3,5 T</p>

Square tree grille with a circular hole made of laser-decorated steel sheet, with ground-inspired pattern. It is composed of two halves arranged for fixing each other with screws and equipped with steel plate reinforcements, placed internally and on the perimeter. Several versions are available, that differ for size and/or hole diameter. It can be accessorized with counter-frame.

Alcorque de forma cuadrada y con foro circular, realizado en chapa de acero decorada a laser con motivos inspirados en la tierra. Se compone de dos mitades predispuestas para que se fijen entre ellas con tornillos y están reforzadas con planchas de acero, puestas internamente y en el perímetro. Disponible en varias versiones por tamaño y/o diámetro del foro. Posibilidad de complementarla con un marco de acero galvanizado.

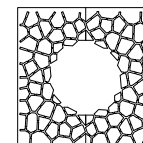
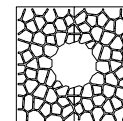
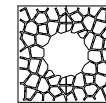

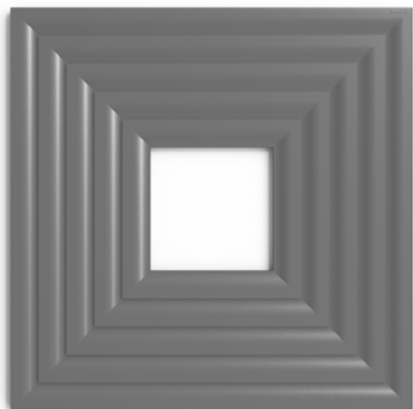

Tree grille in steel made by welding together S-shaped profiles, reinforced in laser cut shaped plates. The shape of the profiles is designed to allow better aeration of the soil. Two square versions are available. It can be accessorized with counter-frame.

Alcorque de acero realizado con perfiles en forma de "S" que van soldados entre ellos y reforzados con una plancha moldeada al láser. La forma de los perfiles ha sido estudiada para permitir una mejor ventilación del terreno. Disponible en dos versiones de forma cuadrada. Posibilidad de complementarla con un marco de acero galvanizado.

## ARBORIS

Designer:	Antonio Citterio con Toan Nguyen
Dimensions/Dimensiones:	1440x1440 mm H 35 mm 1990x1990 mm H 35 mm
Materials/Materiales:	Powder coated steel Acero pintado
Fixing/Fijación:	Below ground installation + Freestanding Cimentación + Apoyo
Accessories/Accesorios:	Counter-frame in galvanized steel Marco en acero galvanizado

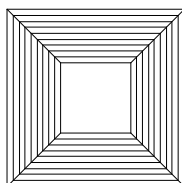
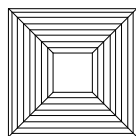



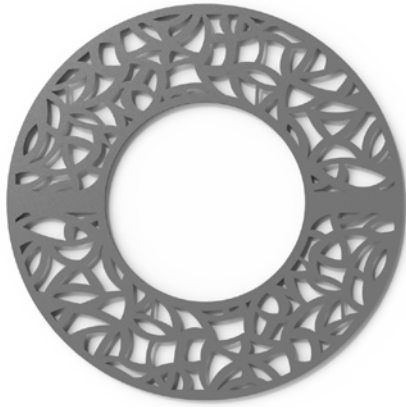

OBRA C

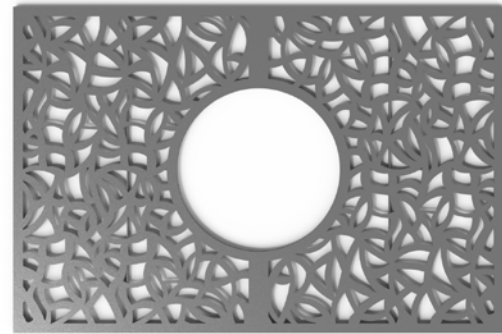

OBRA R

## OBRA C | OBRA R

Designer:	Aurel Design Urbain
Dimensions/Dimensiones:	OBRA C Ø 500 mm Ø 990 mm H 35 mm
	Ø 500 mm Ø 1190 mm H 35 mm
	Ø 800 mm Ø 1440 mm H 35 mm
OBRA R	Ø 500 mm L 1500x1000 mm H 35 mm
	Ø 800 mm L 2300x1495 mm H 35 mm
Materials/Materiales:	Powder coated steel or Stainless steel or Corten steel Acero pintado o Acero Inox o Acero Corten
Fixing/Fijación:	Below ground installation + Freestanding Cimentación + Apoyo
Accessories/Accesorios:	Counter-frame in galvanized steel Marco en acero galvanizado

Tree grille with a circular hole, made of steel sheet laser decorated with floral pattern. It is composed of two halves arranged for their fixing with screws and equipped with steel plate reinforcements, placed internally and on the perimeter. It is available in circular shape (C), rectangular shape (R) and in several versions that differ for size and/or hole diameter. It can be accessorized with counter-frame.

Alcorque de foro circular, realizado en chapa de acero, con decoración hecha a laser y consistente en motivos florales. Se compone de dos mitades predispuestas para que se fijen entre ellas con tornillos y reforzadas con planchas de acero, puestas internamente y en el perímetro. Las formas circular (C) o rectangular (R) están disponibles en varias versiones por tamaño y/o diámetro del foro. Posibilidad de complementarla con un marco de acero galvanizado.

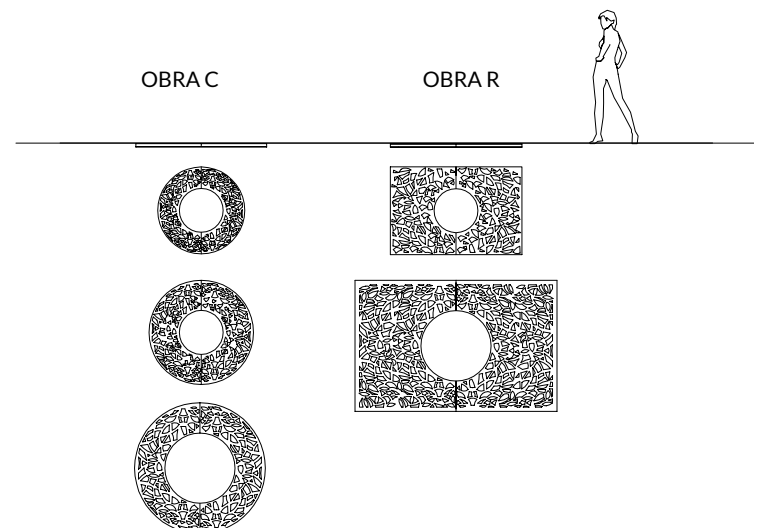

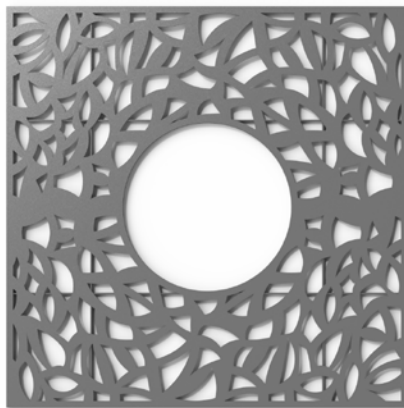

Tree grille with a circular hole, made of steel sheet laser decorated with floral pattern. It is composed of two halves arranged for their fixing with screws and equipped with steel plate reinforcements, placed internally and on the perimeter. It is available in square shape (Q) and in several versions that differ for size and/or hole diameter. It can be accessorized with counter-frame.

Alcorque de forma cuadrada y con foro circular, realizado en chapa de acero, con decoración hecha a laser y consistente en motivos florales. Se compone de dos mitades predispuestas para que se fijen entre ellas con tornillos y reforzadas con planchas de acero, puestas internamente y en el perímetro. La forma cuadrada (Q) está disponible en varias versiones por tamaño y/o diámetro del foro. Posibilidad de complementarla con un marco de acero galvanizado.

## OBRA Q

Designer:	Aurel Design Urbain
Dimensions/Dimensiones:	Ø 500 mm L 990 mm H 35 mm Ø 500 mm L 1190 mm H 35 mm Ø 800 mm L 1440 mm H 35 mm Ø 800 mm L 1990 mm H 35 mm
Materials/Materiales:	Powder coated steel or Stainless steel or Corten steel Acero pintado o Acero Inox o Acero Corten
Fixing/Fijación:	Below ground installation + Freestanding Cimentación + Apoyo
Accessories/Accesorios:	Counter-frame in galvanized steel Marco en acero galvanizado

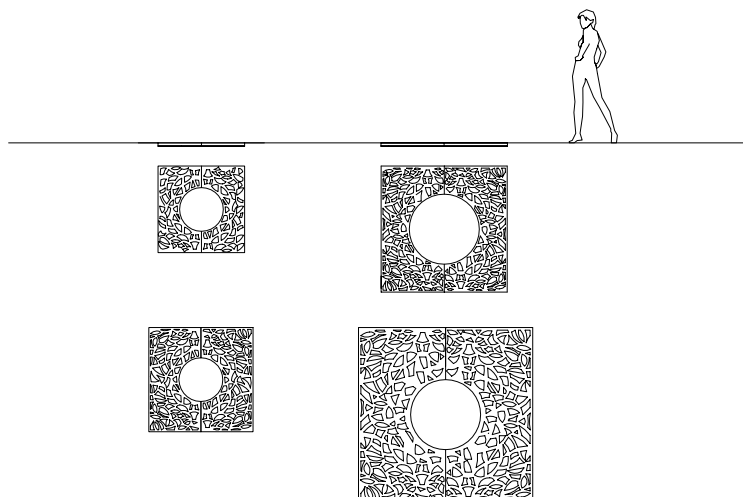



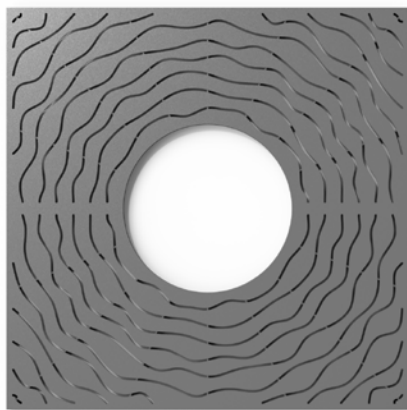

## PERLA Q

Designer:	Raffaele Lazzari
Dimensions/Dimensiones:	<p>Ø 500 mm L 990 mm H 35 mm</p> <p>Ø 500 mm L 1190 mm H 35 mm</p> <p>Ø 800 mm L 1440 mm H 35 mm</p> <p>Ø 800 mm L 1990 mm H 35 mm</p>
Materials/Materiales:	<p>Powder coated steel or Stainless steel or Corten steel</p> <p>Acero pintado o Acero Inox o Acero Corten</p>
Fixing/Fijación:	<p>Below ground installation + Freestanding</p> <p>Cimentación + Apoyo</p>
Accessories/Accesorios:	<p>Counter-frame in galvanized steel</p> <p>Marco en acero galvanizado</p>

Square tree grille with a circular hole, made of steel sheet laser decorated. It is composed of two halves arranged for their fixing with screws and equipped with steel plate reinforcements, placed internally and on the perimeter. It is available in square shape (Q) and in several versions that differ for size and/or hole diameter. It can be accessorized with counter-frame.

Alcorque de forma cuadrada y con foro circular, realizado en chapa de acero, con decoración hecha a laser. Se compone de dos mitades predispuestas para que se fijen entre ellas con tornillos y reforzadas con planchas de acero, puestas internamente y en el perímetro. La forma cuadrada está disponible en varias versiones por tamaño y/o diámetro del foro. Posibilidad de complementarla con un marco de acero galvanizado.

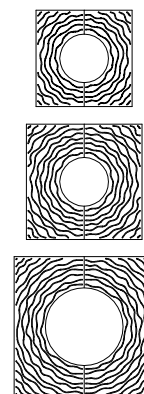

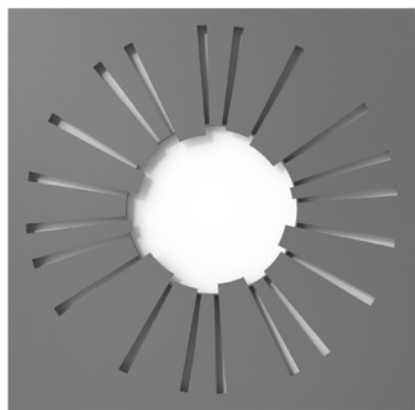

Square tree grille with a circular hole, made of steel sheet laser decorated. It is composed of two halves arranged for their fixing with screws and equipped with steel plate reinforcements, placed internally and on the perimeter. It is available in several versions that differ for size and/or hole diameter. It can be accessorized with counter-frame.

Alcorque de forma cuadrada y con foro circular, realizado en chapa de acero, con decoración hecha a laser. Se compone de dos mitades predispuestas para que se fijen entre ellas con tornillos y reforzadas con planchas de acero, puestas internamente y en el perímetro. Disponible en varias versiones por tamaño y/o diámetro del foro. Posibilidad de complementarla con un marco de acero galvanizado.

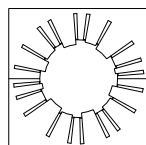
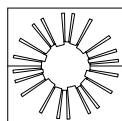
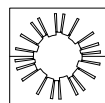

## SUNNY

Designer:	Raffaele Lazzari
Dimensions/Dimensiones:	<p>Ø 500 mm L 990 mm H 35 mm</p> <p>Ø 500 mm L 1190 mm H 35 mm</p> <p>Ø 800 mm L 1440 mm H 35 mm</p>
Materials/Materiales:	<p>Powder coated steel or Stainless steel or Corten steel</p> <p>Acero pintado o Acero Inox o Acero Corten</p>
Fixing/Fijación:	<p>Below ground installation + Freestanding</p> <p>Cimentación + Apoyo</p>
Accessories/Accesorios:	<p>Counter-frame in galvanized steel</p> <p>Marco en acero galvanizado</p>





## PERLA C

Designer:	Raffaele Lazzari
Dimensions/Dimensiones:	<p>Ø 500 mm Ø 990 mm H 35 mm</p> <p>Ø 500 mm Ø 1190 mm H 35 mm</p> <p>Ø 800 mm Ø 1440 mm H 35 mm</p>
Materials/Materiales:	<p>Powder coated steel or Stainless steel or Corten steel</p> <p>Acero pintado o Acero Inox o Acero Corten</p>
Fixing/Fijación:	<p>Below ground installation + Freestanding</p> <p>Cimentación + Apoyo</p>
Accessories/Accesorios:	<p>Counter-frame in galvanized steel</p> <p>Marco en acero galvanizado</p>

Circular tree grille with a circular hole, made of steel sheet laser decorated. It is composed of two halves arranged for their fixing with screws and equipped with steel plate reinforcements, placed internally and on the perimeter. It is available in circular shape (C) and in several versions that differ for size and/or hole diameter. It can be accessorized with counter-frame.

Alcorque de forma circular y con foro circular, realizado en chapa de acero, con decoración hecha a laser. Se compone de dos mitades predispuestas para que se fijen entre ellas con tornillos y reforzadas con planchas de acero, puestas internamente y en el perímetro. Disponible en varias versiones por tamaño y/o diámetro del foro. Posibilidad de complementarla con un marco de acero galvanizado.

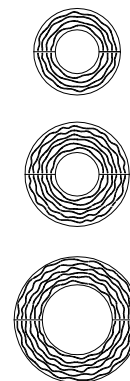



Circular tree grille with a circular hole, made of steel sheet laser decorated. It is composed of two halves arranged for their fixing with screws and equipped with steel plate reinforcements, placed internally and on the perimeter. It is available in several versions that differ for size and/or hole diameter. It can be accessorized with counter-frame.

Alcorque de forma circular y con foro circular, realizado en chapa de acero, con decoración hecha a laser. Se compone de dos mitades predispuestas para que se fijen entre ellas con tornillos y reforzadas con planchas de acero, puestas internamente y en el perímetro. Disponible en varias versiones por tamaño y/o diámetro del foro. Posibilidad de complementarla con un marco de acero galvanizado.

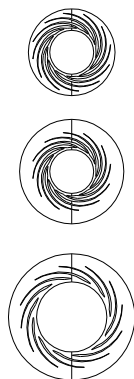

## TWISTER

Designer:	Mattia Li Pomi
Dimensions/Dimensiones:	<p>Ø 500 mm L 990 mm H 35 mm</p> <p>Ø 500 mm L 1190 mm H 35 mm</p> <p>Ø 800 mm L 1440 mm H 35 mm</p>
Materials/Materiales:	<p>Powder coated steel or Stainless steel or Corten steel</p> <p>Acero pintado o Acero Inox o Acero Corten</p>
Fixing/Fijación:	<p>Below ground installation + Freestanding</p> <p>Cimentación + Apoyo</p>
Accessories/Accesorios:	<p>Counter-frame in galvanized steel</p> <p>Marco en acero galvanizado</p>



RAFFAELE LAZZARI  
MATTIA LI POMI

---



# DRINKING FOUNTAINS: A REFRESHMENT POINT

Fuentes:  
una restauración  
accesible



PARAGUAS



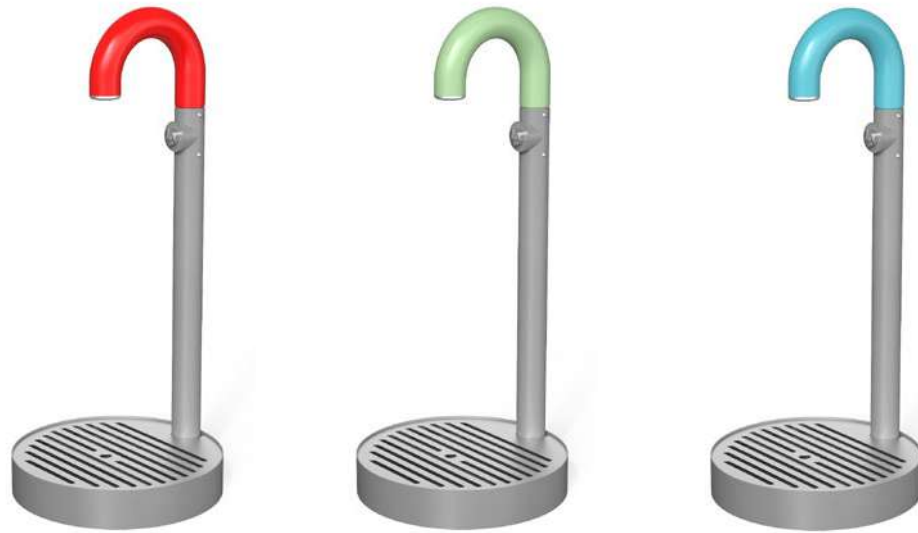

Drinking fountain composed of a steel tube structure, a chrome-plated brass tap with push button provided with a return spring and a circular tank. The latter is equipped with a drainage pipe with an overflow system and a removable drain for cleaning purposes.

Fuente consistente en una estructura en tubo de acero con grifo en otón cromado y pulsador con muelle de retorno y de un recipiente circular en chapa de acero. Este último está dotado de un tubo para el desagüe con un sistema de drenaje y de una reja amovible para permitir la limpieza.

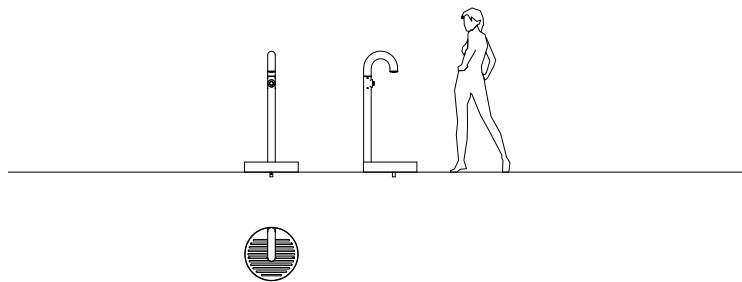

## PARAGUAS

Designer:	Raffaele Lazzari + Mattia Li Pomi	
Dimensions and weight	Ø 536 mm H 1112 mm	27 kg
Dimensions and peso:		
Materials/Materiales:	Powder coated steel + Stainless steel Acero pintado + Acero Inox	
Fixing/Fijación:	Below ground installation Cimentación	



FUENTE DOG





Fountain composed of an elliptical steel sheet structure and two chrome-plated brass push button taps: one with stainless steel bowl for animals, the other with a rectangular tank. The latter is equipped with two drainage pipes with an overflow system and a removable drain for cleaning purposes.

Fuente formada por una estructura elíptica en chapa de acero con doble grifo en otón cromado y pulsador con muelle de retorno, uno con un cuenco en Inox para animales y el otro con un recipiente rectangular. Este último está dotado de un tubo para el desagüe con un sistema de drenaje y de una reja amovible para permitir la limpieza.

## FUENTE DOG

Designer:	Raffaele Lazzari + Matia Li Pomi	
Dimensions and weight	295x890x990 mm	29 kg
Dimensiones y peso:		
Materials/Materiales:	Powder coated steel or Stainless steel or Corten steel Acero pintado o Acero Inox o Acero Corten	
Fixing/Fijación:	Below ground installation Cimentación	

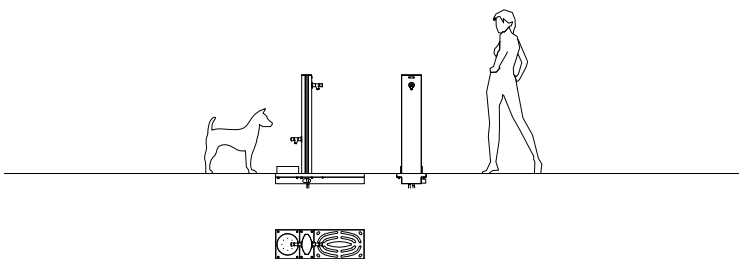





www.metalab.com  
+39 0423 7981



FUENTE C

FUENTE E

FUENTE R



Collection of drinking fountains composed of a steel sheet structure, a chrome-plated brass tap with push button provided with a return spring and a rectangular tank. The latter is equipped with a drainage pipe with an overflow system and a removable drain to allow cleaning. The back of the tank is equipped with a slit for the connection of water supply. Three different models with rectangular, circular or elliptical.

Colección de fuentes constituida de una estructura en chapa de acero con un grifo en otón cromado y pulsador con muelle de retorno y de un recipiente rectangular. Este último está dotado de un tubo para el desagüe con un sistema de drenaje y de una rejilla amovible para permitir la limpieza. En la parte trasera del recipiente, hay una abertura adapta para la conexión de la tubería de alimentación. Disponible en tres modelos diferentes de forma rectangular, circular y elíptica.

## FUENTE C | E | R

Designer:	Raffaele Lazzari	
Dimensions and weight Dimensiones y peso:	C 102x102 mm	22 kg
	E 200x100 mm	25 kg
	R 200x100 mm	27 kg
Materials/Materiales:	Powder coated steel or Stainless steel or Corten steel Acero pintado o Acero Inox o Acero Corten	
Fixing/Fijación:	Below ground installation Cimentación	

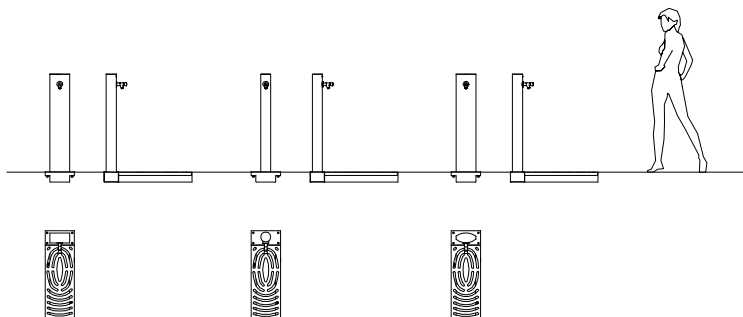



ANTONIO CITTERIO CON TOAN NGUYEN

PAMIO DESIGN

INDIO DA COSTA AUDT

BETANCOURTDESIGN

STUDIO KUADRA

ALFREDO TASCA

METALCO DESIGN

SJIT

---



# DISPLAY UNITS AND POLES: INFORMATION TAILORED TO PEOPLE

Expositores y  
paneles informativos:  
información a medida  
de las personas





## ALTUS | LATUS

Designer:	Antonio Citterio con Toan Nguyen
Dimensions and weight Dimensiones y peso:	1334x200 mm H 2777 (+ 400) mm 78 kg
	1734x200 mm H 2407 (+ 400) mm 85 kg
Materials/Materiales:	Powder coated aluminum + Powder coated steel Aluminio pintado + Acero pintado
Fixing/Fijación:	Below ground installation Cimentación
Accessories/Accesorios:	Custom graphics Gráficas personalizadas

Collection of double-sided display boards composed of two vertical elements in aluminum, with a steel inner core, equipped with a vertical groove with spacers that allows the insertion of a panel made of steel tube and steel sheet. The board is designed with an upper shaped steel element for the application of logos, coats of arms or texts to be displayed. Two models are available: with display surface 1000x1400 mm and 1400x1000 mm.

Colección de expositores a dos caras compuestos de dos elementos verticales realizados en aluminio, con el núcleo interno en acero, dotado de una ranura vertical con espaciadores que permite la inserción de un panel realizado en tubo de acero con cierre en chapa de acero. La parte superior de la estructura dispone de un elemento superior en acero perfilado para la aplicación de logos, escudos o adhesivos. Disponible en dos modelos: área de exhibición 1000x1400 mm / 1400x1000 mm.

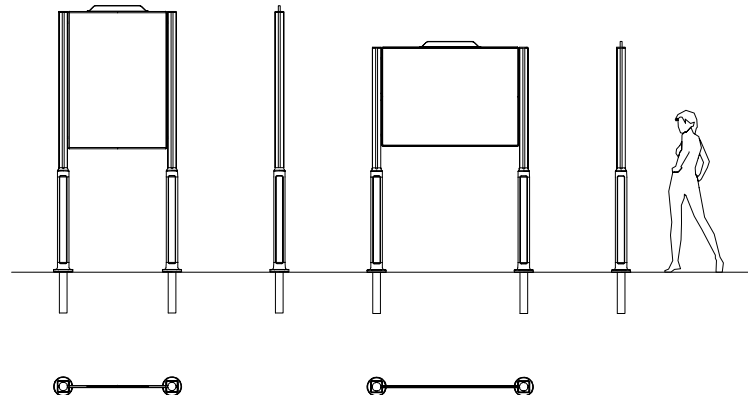



Single-sided steel display board with showcase made of steel with perimeter edging in stainless steel plate. The display surface, measuring 934x455 mm, is protected by tempered glass equipped with hinges and a locking system.

Expositor a una cara con vitrina realizado en acero con borde perimetral en chapa de acero Inoxidable. El área de exhibición, de dimensiones 934x455 mm, está protegido por un cristal templado sujeto por bisagras y dotado de una cerradura con llave.

## ANNUNCI

Designer:	Pamio Design	
Dimensions and weight Dimensiones y peso:	461x180 mm H 2098 mm	77 kg
Materials/Materiales:	Powder coated steel o Stainless steel Acero pintado o Acero Inox	
Fixing/Fijación:	Pre-drilled for anchors Predisposición para tacos	

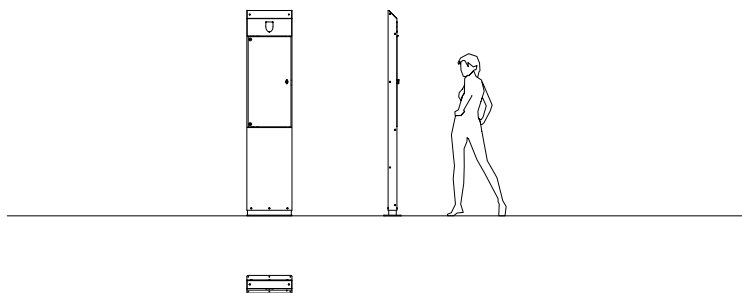





One-sided display board with showcase composed of a supporting structure glass formed by two vertical tube supports and steel plate and by a panel in steel sheet. The display surface is protected by a door made of an aluminum extruded profile, with triangular box side lock, and a shatterproof glass sheet. Two models are available, with display surface 700×1000 mm and 1400×1000 mm.

Expositor a una cara con vitrina compuesta de una estructura portante formada por dos soportes en tubo verticales y una placa de acero y de un panel en chapa de acero. El área de exhibición está protegida por una puerta en extrusión de aluminio con cerradura lateral de caja triangular y de una hoja de vidrio irrompible. Disponible en dos modelos con áreas de exhibición 700×1000 o 1400×1000 mm.

## BACH

Designer:	Metalco Design
Dimensions and weight Dimensiones y peso:	839x100 mm H 1980 mm (+ 300 mm) 80 kg
	1539x100 mm H 1980 mm (+ 300 mm) 110 kg
Materials/Materiales:	Powder coated aluminum + Powder coated steel Aluminio pintado + Acero pintado
Fixing/Fijación:	Below ground installation Cimentación

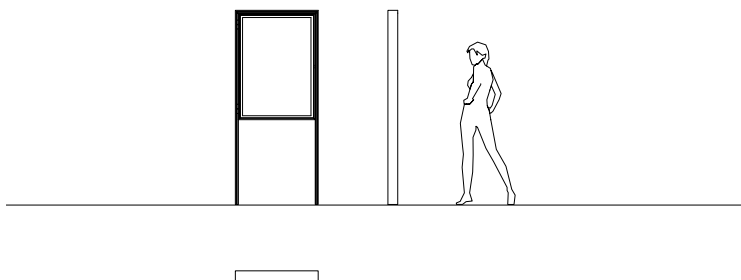









One-sided information panel composed of a curved profile and a stainless steel shaped panel, fixed to the support with flat headed, countersunk screws. The display surface, measuring 270x600 mm, can be customized with stickers, pre-spaced lettering or serigraphy.

Panel informativo a una cara compuesto por un soporte con forma de caja curva y por un panel perfilado en acero Inoxidable fijado al soporte mediante tornillos de cabeza avellanada plana. Área de exhibición 270x600 mm, personalizable con adhesivos, letras pre-espaciadas o serigrafía.

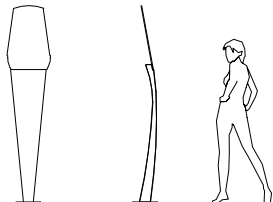

## ATHOS

Designer:	Alfredo Tasca	
Dimensions and weight	436x250 mm H 2000 mm	35 kg
Dimensiones y peso:		
Materials/Materiales:	Powder coated steel or Corten steel + Stainless steel Acero pintado o Acero Corten + Acero Inox	
Fixing/Fijación:	Pre-drilled for anchors Predisposición para tacos	
Accessories/Accesorios:	Custom graphics Gráficas personalizadas	



### The Speakers

"There was something about these people. I mean, what makes somebody want to come down week after week and believe in this word? Where they mind?"

Small text below the quote: *© 2011 The Speaker by [unreadable] in [unreadable] in [unreadable]*

Two small images: a person at a podium and a group of people.







Collection of double-sided display boards made of steel sheet and stainless steel base. Two models are available: one with a display surface, measuring 700x1000 mm, protected by two polycarbonate sheets, the other with two tempered glass doors, equipped with hinges and a locking system. The display board is complete with an aesthetic front panel in square brushed stainless steel tube.

Colección de expositores a dos caras realizadas en chapa de acero con zócalo base en acero Inoxidable. Disponibles dos modelos: uno con un área de exhibición protegida por dos placas de policarbonato, el otro por dos puertas en cristal templado sujetas por bisagras y dotadas de cerradura. El tótem se completa con un elemento estético en tubo de acero inoxidable. Área de exhibición 700x1000 mm.

## ICARO

Designer:	Sjit
Dimensions and weight Dimensiones y peso:	900x200 mm H 2050 mm 117   121 kg
Materials/Materiales:	Powder coated steel or Stainless steel or Corten steel Acero pintado o Acero Inox o Acero Corten
Fixing/Fijación:	Pre-drilled for anchors Predisposición para tacos

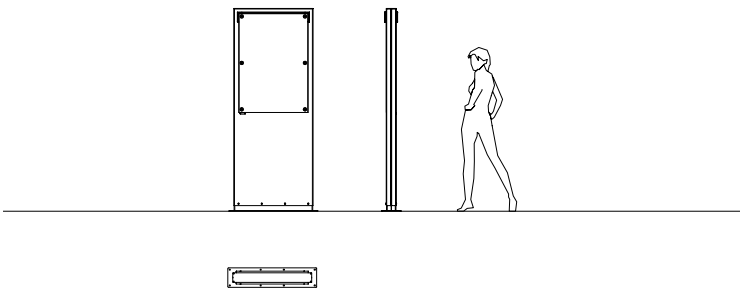



CHAMONIX

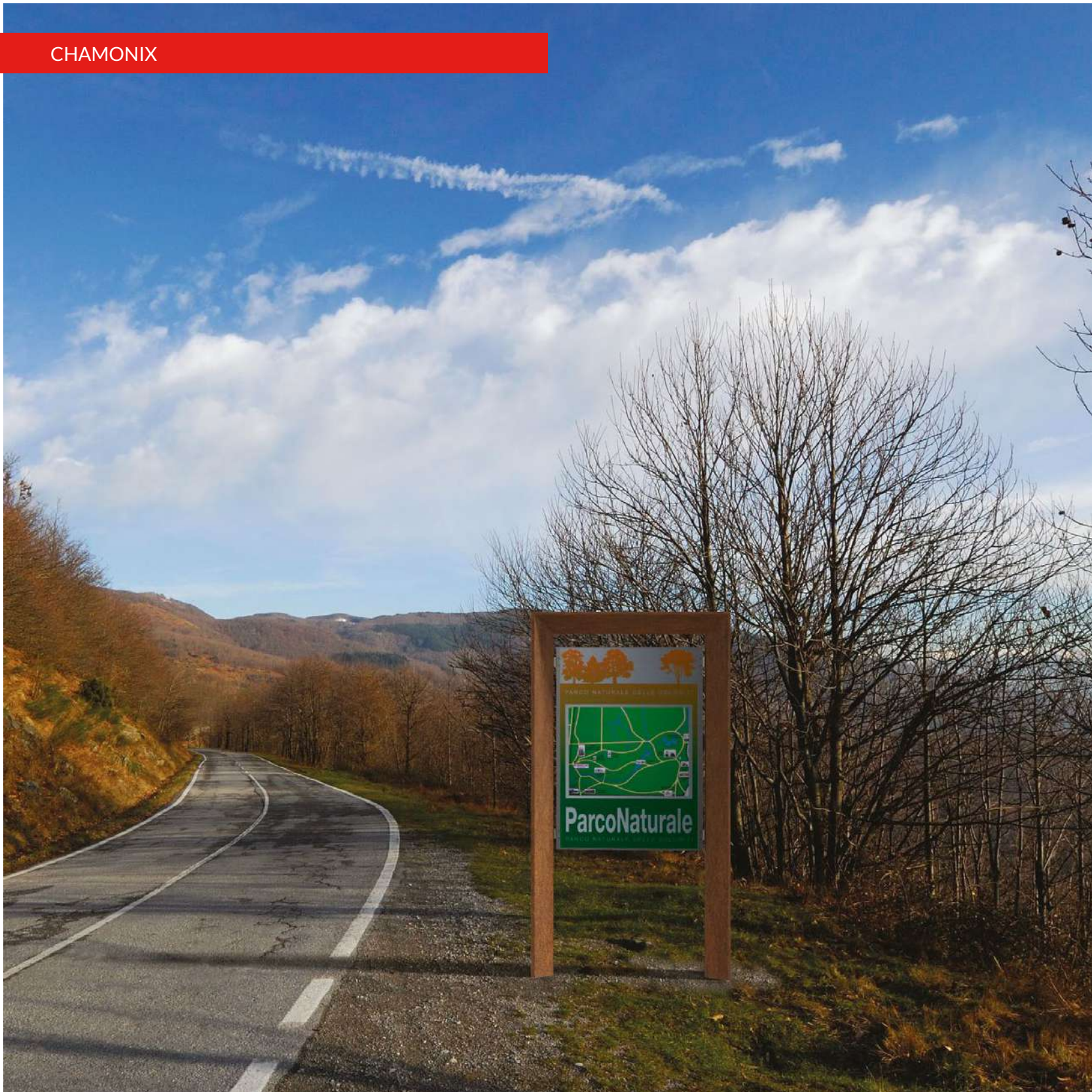





Double-sided steel sheet information panel with a support structure composed of two vertical triangular poles with a steel tube inner core. Three models are available: with display surface of 700X1000 mm, 1000x1400 mm and 1400x1400mm, customizable with stickers, pre-spaced lettering or serigraphy.

Expositor de doble cara formado por una estructura portante compuesta de dos soportes verticales en sección triangular, con núcleo interno en tubo de acero y de un panel en chapa de acero. Disponible en tres modelos con área de exhibición 700x1000 mm / 1000x1400 mm / 1400x1400 mm, personalizable con adhesivos, escritura pre-espaciada o serigrafía.

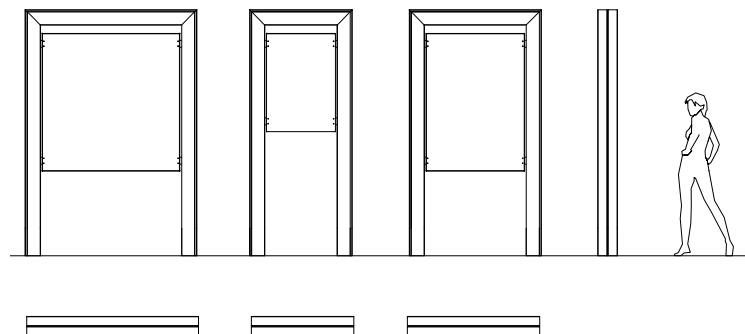

## CHAMONIX

Designer:	Metalco Design
Dimensions and weight Dimensiones y peso:	1030x160 mm H 2500 mm (+ 400 mm) 95 kg
	1330x160 mm H 2500 mm (+ 400 mm) 116 kg
	1730x160 mm H 2500 mm (+ 400 mm) 134 kg
Materials/Materiales:	Powder coated steel or Corten steel Acero pintado o Acero Corten
Fixing/Fijación:	Below ground installation Cimentación

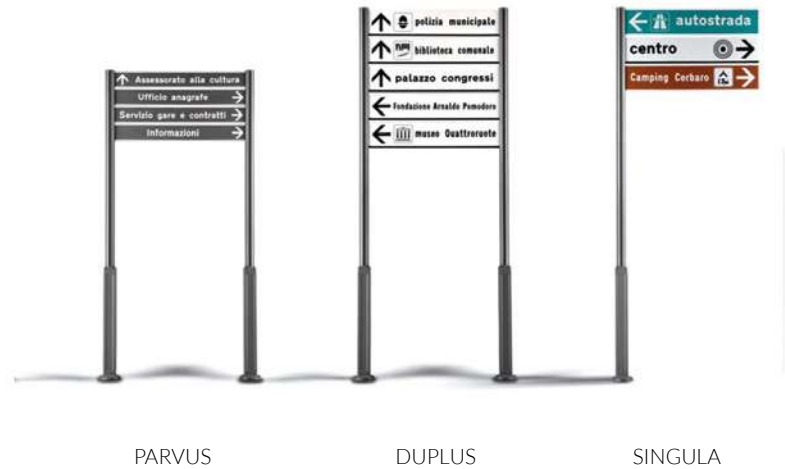

PARVUS

DUPLUS

SINGULA

## DUPLUS | PARVUS | SINGULA

Designer:	Antonio Citterio con Toan Nguyen
Dimensions and weight Dimensiones y peso:	<p><b>DUPLUS</b> 1545x200 mm H 3590 mm (+ 400 mm) 90 kg</p> <p><b>PARVUS</b> 1545x200 mm H 3090 mm (+ 400 mm) 72 kg</p> <p><b>SINGULA</b> 1420x200 mm H 3590 mm (+ 400 mm) 48 kg</p>
Materials/Materiales:	Powder coated aluminum + Powder coated steel Aluminio pintado + Acero pintado
Fixing/Fijación:	Below ground installation Cimentación
Accessories/Accesorios:	Custom graphics Gráficas personalizadas

Duplus and Parvus information posts are composed of two vertical aluminum elements, with steel inner core, equipped with a vertical groove and signage boards in extruded aluminum. They differ in height and they can accommodate up to five boards. The flag model Singula is composed of a vertical element in aluminum, with steel inner core, equipped with a groove to accommodate up to a maximum of three boards.

Los modelos Duplus y Parvus están compuestos de dos elementos verticales en aluminio, con núcleo interno en acero, dotados de una ranura vertical y de paneles de señalización en extrusión de aluminio. Se diferencian por la altura y pueden abarcar hasta 5 carteles. El modelo Singula, "a bandera", está formado de un elemento vertical en aluminio, con núcleo interno en acero, dotado de una ranura para albergar hasta un máximo de 3 carteles.

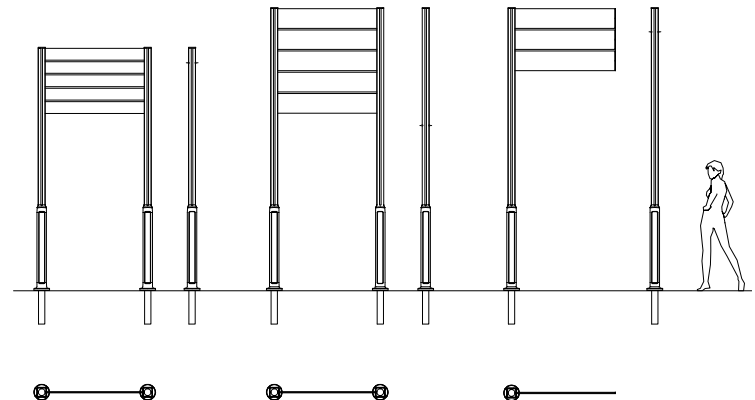



PARANÀ





Double-sided display board composed of a supporting structure in UHPC (Ultra High Performance Concrete) and a steel sheet panel. Display surface: 600x1400 mm.

Expositor a doble cara formado de una estructura portante en UHPC (Ultra High Performance Concrete) y de un panel en chapa de acero. Área de exhibición con dimensiones 600x1400 mm.

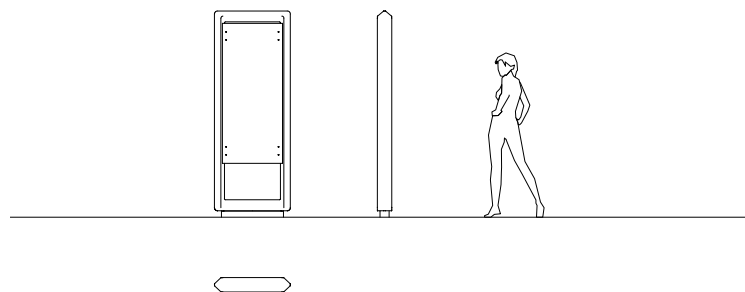

## PARANÀ

Designer:	Indio Da Costa AUDT
Dimensions and weight Dimensiones y peso:	760x145 mm H 2065 mm 180 kg
Materials/Materiales:	UHPC (Ultra High Performance Concrete) + Powder coated steel UHPC (Ultra High Performance Concrete) + Acero pintado
Finishes/Acabados:	UHPC Alfa - Natural smooth UHPC Alfa - Liso natural
Fixing/Fijación:	Below ground installation Cimentación
Accessories/Accesorios:	Custom graphics Gráficas personalizadas





## SENNA

Designer:	Metalco Design	
Dimensions and weight Dimensiones y peso:	510x110 mm H 2250 mm	60 kg
	730x110 mm H 2250 mm	70 kg
Materials/Materiales:	Powder coated steel or Corten steel + Composite aluminum Acero pintado o Acero Corten + Compuesto de aluminio	
Fixing/Fijación:	Pre-drilled for anchors Predisposición para tacos	
Accessories/Accesorios:	Custom graphics Gráficas personalizadas	

Collection of double-sided display boards composed of a supporting structure in steel plate and a composite aluminum panel. Two models are available, with display surface 480x1400 mm and 700x1400 mm. It can be customized with stickers, pre-spaced lettering or serigraphy.

Colección de expositores a doble cara formadas por una estructura portante en placa de acero y un panel de aluminio compuesto. Disponibles dos modelos con áreas de exposición 480x1400 mm / 700x1400 mm, pudiendo ser personalizado con adhesivos, escritura pre-espaciada o serigrafía.

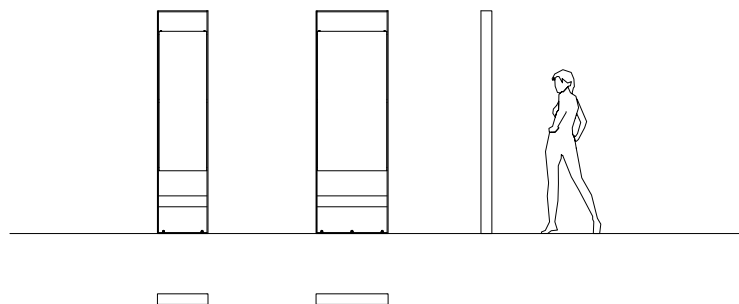



Double-sided display board composed of a steel supporting structure made of T section profiles and a double steel sheet. The display surface measures 1000x1400 mm.

Expositor a doble cara formado por una estructura portante en acero realizada con perfiles de secciones en forma de "T" y de un doble marco en chapa de acero. Área de exhibición 1000x1400mm.

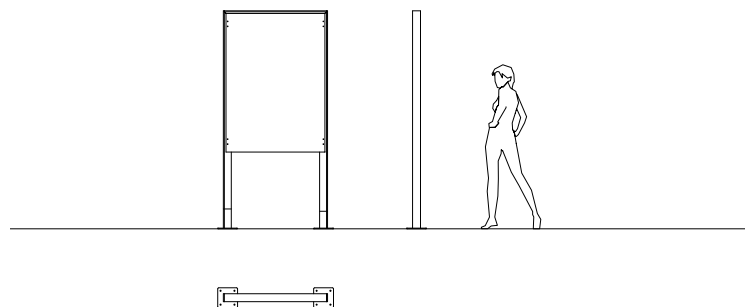

## TARGA

Designer:	Betancourt design
Dimensions and weight Dimensiones y peso:	1050x200 mm H 2200 mm (+ 300 mm) 95 kg
Materials/Materiales:	Powder coated steel or Corten steel Acero pintado o Acero Corten
Fixing/Fijación:	Pre-drilled for anchors or Below ground installation Predisposición para tacos o Cimentación



**ANTONIO CITTERIO** CON TOAN NGUYEN  
**PININFARINA**  
**INDIO DA COSTA AUDT**  
**STAUBACH & KUCKERTZ**  
**ALFREDO TASCA**  
**MASSIMO TASCA**  
**MATTIA LI POMI**  
**NONIS + MATRORILLI + GOZZETTI**  
**DESIGN LABORATORIO DI ARCHITETTI ASSOCIATI +**  
**ANDREA RINALDI + ROBERTA CASARINI**

---



# SHELTERS: COMFORT FOR WAITING IN THE CITY

Marquesinas:  
el confort  
para la espera  
en ciudad





## ALHENA

Designer:	Pininfarina
Dimensions/Dimensiones:	L 3640x1600 mm l 2777 mm H 2710 mm h 2320 mm
Materials/Materiales:	Powder coated steel Acero pintado
Fixing/Fijación:	Pre-drilled for anchors Predisposición para tacos
Accessories/Accesorios:	Steel bench Banco en acero
	Lateral advertisement display Panel publicitario lateral
	Information board Panel informativo en el cerramiento de fondo
	Lighting system Iluminación

Shelter composed of a supporting structure in steel tube, a back wall composed of a frame in steel profiles with two tempered glass sheets and a cover in shaped steel sheet, with edge in powder coated extruded aluminum. One side of the supporting structure is covered with curved metal sheets that create an elliptical profile: in the lower part it is equipped with a litter bin with bag holder ring and a door with lock, while, in the upper part, it can accommodate a panel for advertising posters. On the opposite side, an aluminum information panel with snap lock is integrated. The glass sheets can be equipped with holes for the installation of an additional aluminum display board with snap closure. The shelter can be completed with a steel bench without backrest, whose seat is decorated with holes.

Marquesina formada por una estructura portante en tubo de acero, por un cerramiento de fondo compuesto por una estructura con perfiles de acero con dos hojas de vidrio templado y por una cubierta en chapa de acero moldeada, con los bordes en extrusión de aluminio pintado. La estructura portante está revestida por un lado de una chapa curva que crea un perfil elíptico, equipado, en la parte inferior, de una papelerera con anillo de sujeción de bolsas y puerta con cerradura y en la parte superior, se puede optar por aplicar un panel publicitario. En el lado opuesto, un expositor con cierre a presión. Las hojas de vidrio pueden dotarse de orificios para la instalación de otro expositor en aluminio con cierre a presión. La marquesina puede completarse con un banco con respaldo en acero, con el asiento decorado con orificios.

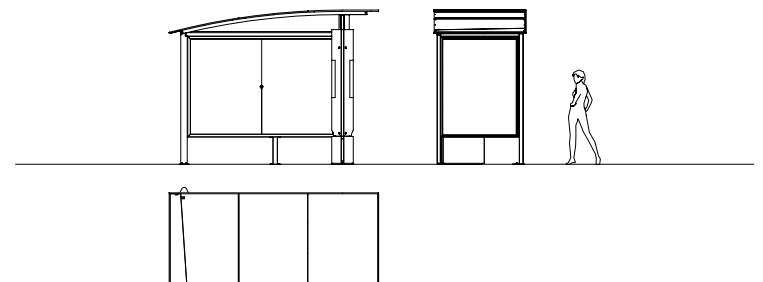



Shelter composed of a supporting structure in steel tube, a back wall composed of a frame in steel profiles with two tempered glass sheets and a cover in shaped steel sheet, with edge in powder coated extruded aluminum. One side of the supporting structure is covered with curved metal sheets that create an elliptical profile: in the lower part the latter is equipped with a litter bin with bag holder ring and door with lock, while, in the upper part, it can accommodate a panel for advertising posters. On the opposite side, an aluminum information panel with snap lock is integrated. The glass sheets can be equipped with holes for the installation of an additional aluminum display board with snap closure. The shelter can be completed with a steel bench without backrest, whose seat is decorated with holes.

Marquesina formada por una estructura portante en tubo de acero, por un cerramiento de fondo realizado en perfiles de acero con hojas de vidrio templado y por una cobertura en chapa de acero perfilada, con un borde en extrusión de aluminio pintado. La estructura portante está revestida, por un lado, con chapas curvas que crean un perfil elíptico, dotada, en la parte inferior, de papelera con anillo de sujeción de bolsas y puerta con cerradura, en la parte superior puede albergar un panel publicitario. En el lado opuesto se integra un expositor en aluminio con cierre a presión. Las hojas de vidrio pueden disponer de orificios para la instalación de otro expositor en aluminio con cierre a presión. La marquesina se puede equipar con un banco de acero sin respaldo, con asiento decorado con orificios.

## MERAK

Designer:	Pininfarina
Dimensions/Dimensiones:	L 6060x1600 mm I 2777+2777 mm H 2710 mm h 2320 mm
Materials/Materiales:	Powder coated steel Acero pintado
Fixing/Fijación:	Pre-drilled for anchors Predisposición para tacos
Accessories/Accesorios:	Steel bench Banco en acero  Lateral advertisement display Affichage publicitaire latéral  Information board Panel informativo en el cerramiento de fondo  Lighting system Iluminación

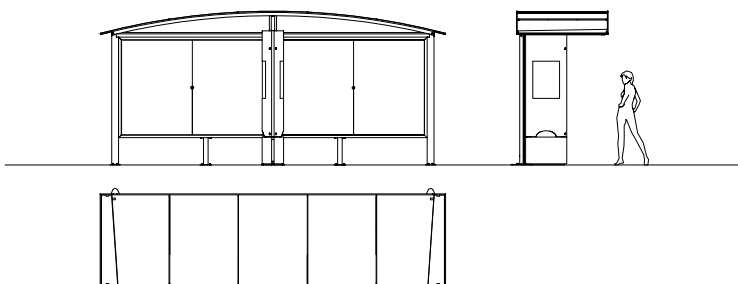









Modular shelter composed of grooved extruded aluminum columns and equipped with an internal structural reinforcement in steel and a base plate, back panels made of coupled glass or perforated steel sheet and cantilevered roof. The load-bearing back columns are connected at the top by an aluminum extruded profile which acts as rain water outlet. At the top they have a stainless steel vertical stainless steel coupling equipped with tie rods to support a structure of ribs and counter ribs supporting the roof. The latter is composed of transparent or smoked methacrylate sheets, connected by an aluminum profile in the outer end. The shelter is provided with a stainless steel tube handrail which is fixed to the rear columns. The shelter can be supplied complete with a steel bench without backrest, a Side wall in glass or perforated steel sheet, rear and side advertisement board, sign plate and a LED lighting system.

Marquesina modular formada por columnas en extrusión de aluminio y dotado de un refuerzo estructural interno en acero y placa base, por un cerramiento de fondo compuesto por paneles de vidrio acoplados o en chapa de acero perforada y por una cobertura en voladizo. Las columnas de fondo hacen de pilar y están conectadas entre ellas, por la parte superior, con una extrusión de aluminio que hace de desagüe de las aguas pluviales. En la parte superior tienen un injerto vertical en acero inoxidable dotado de ganchos para soportar una estructura de nervaduras y contra nervaduras que sostienen la cubierta formada por hojas de metacrilato transparente o ahumado, unidas, en la parte externa, por un perfil de aluminio. La marquesina está equipada con un pasamanos en tubo de acero inoxidable fijado en las columnas de fondo. Se puede completar con un banco sin respaldo de acero, con cerramiento lateral de vidrio o chapa perforada, con panel publicitario lateral o de fondo, con una placa de identificación de parada y con un sistema de iluminación LED.

## ARTS

Designer:	Alfredo Tasca
Dimensions/Dimensiones:	2 mod: L 2420x1755 mm   1083 mm 3 mod: L 3500x1755 mm   1083 mm 4 mod: L 4580x1755 mm   1083 mm 5 mod: L 5660x1755 mm   1083 mm H 3144 mm h 2680 mm
Materials/Materiales:	Powder coated aluminum + Powder coated steel + Stainless steel Aluminio pintado + Acero pintado + Acero Inox
Fixing/Fijación:	Plate with anchors Planchas con tirafondos
Accessories/Accesorios:	Steel bench - Banco en acero Side wall in glass or perforated steel sheet Cerramiento lateral en vidrio o chapa perforada Information board Panel informativo en la pared de fondo Advertisement side wall Pared publicitaria lateral Sign plate - Placa identificación parada Lighting system - Iluminación

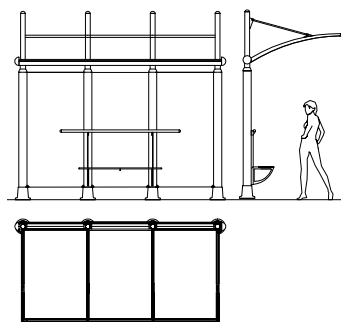



CABINEDDA

In/Architettura

2020







Collection of shelters composed of a bridge-shaped steel structure, covered externally and internally by Corten steel sheets. Available with internal coating in panels in Okumé plywood. The back walls are made of coupled and tempered glass. The shelter can be completed by single-seater seats to create a waiting area and a LED lighting system, integrated in the lower wall of the roof.

Colección de marquesinas formadas por una estructura a forma de puente de acero, revestida, externa e internamente, con chapas de acero Corten. Disponible versión revestida internamente con listones en madera multilaminada Okume. Los cerramientos de fondo son de vidrio templado acoplado. La marquesina se puede equipar con un sistema de asientos monoplaza para crear una zona de espera y con un sistema de iluminación LED, integrado en la pared inferior de la cobertura.

## CABINEDDA

Designer:	Davide Fancello
Dimensions/Dimensiones:	4570x2285 mm H 2515 mm
Materials/Materiales:	Corten steel + Okumè wood Acero Corten + Madera de Okumè
Fixing/Fijación:	Pre-drilled for anchors Predisposición para tacos
Accessories/Accesorios:	LED lighting Iluminación LED

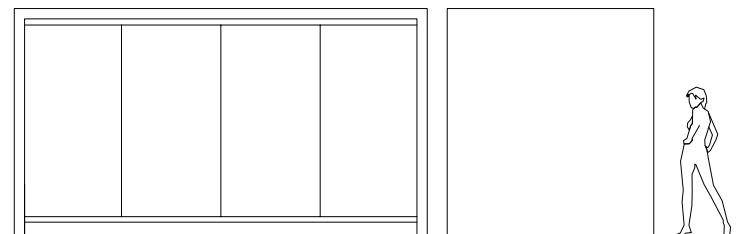





## SELF

Designer:	Alfredo Tasca + Mattia Li Pomi
Dimensions/Dimensiones:	3885x1915 mm H 2340 mm
Materials/Materiales:	PDM (Reconstituted Stones) + Powder coated steel PDM (Piedras Reconstituidas) + Acero pintado
Finishes/Acabados:	Brushed seat + Sandblasted sides Parte superior trabajada con púas rígidas + Laterales tratados con chorro de arena
Fixing/Fijación:	Installation with threaded bars Cimentación con varillas roscadas
Accessories/Accesorios:	Display board Expositor

Self-supporting shelter composed of a bridge-shaped structure, in steel tube, which rests on two monoliths in PDM (Reconstituted Stones), which serve both as base and as seat. The roof is composed of insulated or laminated and tempered glass sheets. The side and back walls are made of tempered glass. The glass sheets can be equipped with holes for the installation of an additional display board.

Marquesina autoportante formada por una estructura a forma de puente, en tubo de acero, que se apoya sobre dos monolitos en PDM (Piedras Reconstituidas), que actúan como base y como superficie de asiento. La cobertura se compone de paneles planos aislados o de vidrio acoplado y templado. Los cerramientos laterales y de fondo son de vidrio templado. Las hojas de vidrio se pueden equipar con orificios para la instalación de un expositor.

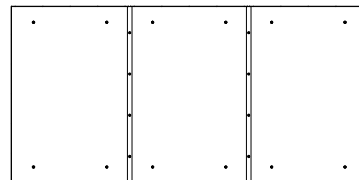
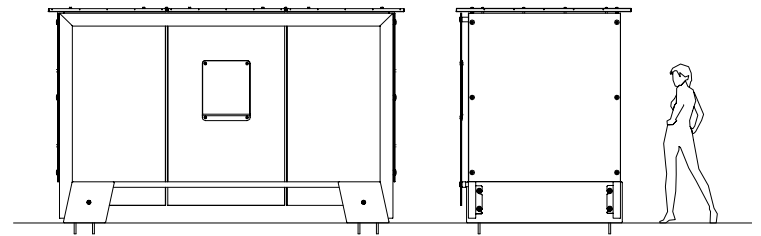



## FOGLIA

Designer: **Nonis + Matrorilli + Gozzetti**

Dimensions/Dimensiones: **SMALL - PEQUEÑA:**  
6826x4104 mm  
H 3300 | 3681 | 4131 mm

**BIG - GRANDE:**  
7676x4276 mm  
H 3300 | 3695 | 4135 mm

Materials/Materiales: **Powder coated steel**  
**Acero pintado**

Fixing/Fijación: **Pre-drilled for anchors**  
**Predisposición para tacos**

Modular collection of shading roofs composed of steel load-bearing columns equipped with base plate and designed to accommodate a lighting system. The roof is composed of a steel tube frame covered below by steel sheet and on the top by an insulated panel and protected by a waterproof sheath applied on site. The appropriate slope of the roof ensures the water runs inside one of the load-bearing columns.

Colección modular de coberturas para dar sombra formada por columnas portantes en acero dotadas de placa base y diseñadas para albergar un sistema de iluminación. La cobertura está formada por una estructura en tubo de acero revestido en la parte inferior por placas en chapa de acero, en la parte superior por un panel de aislamiento, protegido por un sistema de impermeabilización aplicado in situ. La inclinación de la cobertura favorece el desagüe del agua al interior de una de las columnas portantes.

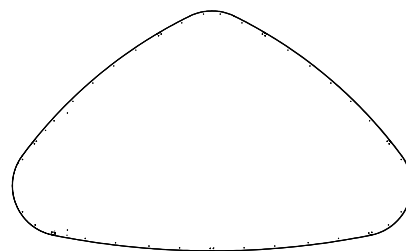
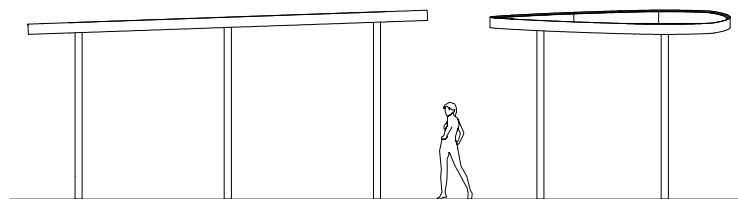





Modular shelter composed of a load-bearing structure in steel profiles, a back wall made of tempered glass sheets which connects to a coupled and tempered glass cover through an aluminum profile. The shelter can accommodate a LED lighting system, a steel bench with or without backrest and it can be completed with tempered glass side wall or with an autonomous side wall, composed of a steel frame with integrated display board.

Marquesina modular formada por una estructura portante en perfiles de acero, por un cerramiento de fondo en hoja de vidrio templado, que, a través de un perfil en aluminio, se sujeta a una cobertura en vidrio acoplado y templado. La marquesina se puede equipar con un sistema de iluminación LED, un banco en acero con o sin respaldo y se puede completar con un cerramiento lateral en vidrio templado o con un cerramiento lateral autónomo, formado de una estructura en acero con expositor integrado.

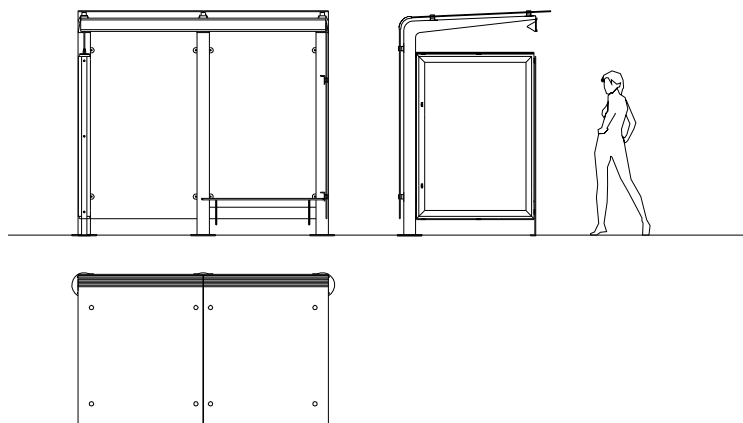

## SINTESI

Designer:	Alfredo Tasca
Dimensions/Dimensiones:	2 mod: L 2840x1750 mm I 1350 mm 3 mod: L 4190x1750 mm I 1350 mm H 2553 mm
Materials/Materiales:	Powder coated steel + Glass Acero pintado + Vidrio
Fixing/Fijación:	Plate with anchors Planchas con tirafondos
Accessories/Accesorios:	Steel bench Banco en acero  Glass side wall Cerramiento lateral en vidrio  Advertisement side wall Pared publicitaria lateral  Lighting system Iluminación

HUT









## HUT

Designer: Alfredo Tasca

Dimensions/Dimensiones: 2 mod:  
L 2860x1690 mm | 2760 mm

3 mod:  
L 4240x1690 mm | 4140 mm

4 mod:  
5660x1690 mm | 2760 mm  
H 2565 mm (+155 mm)

3 mod:  
L 4240x1690 mm  
| 1380+2760 mm (with advertising board -  
con panel publicitario)

Materials/Materiales: Powder coated steel  
Acero pintado

Fixing/Fijación: Plate with anchors  
Planchas con tirafondos

Accessories/Accesorios: Glass side wall  
Cerramiento lateral en vidrio

Advertisement side wall  
Pared publicitaria lateral

LED lighting  
Iluminación LED

False ceiling  
Falso techo ciego





Collection of shelters composed of a load-bearing structure and a roof, both in steel tube and a back wall in coupled glass sheets. The roof is covered on the top – and upon request also below – by steel sheets. The roof is designed to accommodate a top sign holder in extruded aluminum, a bench without backrest made of steel with wooden seat, and it can be accessorized with back or side advertising board.

Colección de marquesinas formadas por una estructura portante y por una cobertura, ambas en tubo de acero y por un cerramiento de fondo en hojas de vidrio acoplado. La cobertura está revestida en la parte superior en chapa de acero (bajo solicitud, también se puede revestir la parte inferior). La marquesina ha sido predispuesta para poder equiparse con una placa de identificación de parada en extrusión de aluminio, un banco sin respaldo, en acero con asiento de madera y con panel publicitario lateral o de fondo.

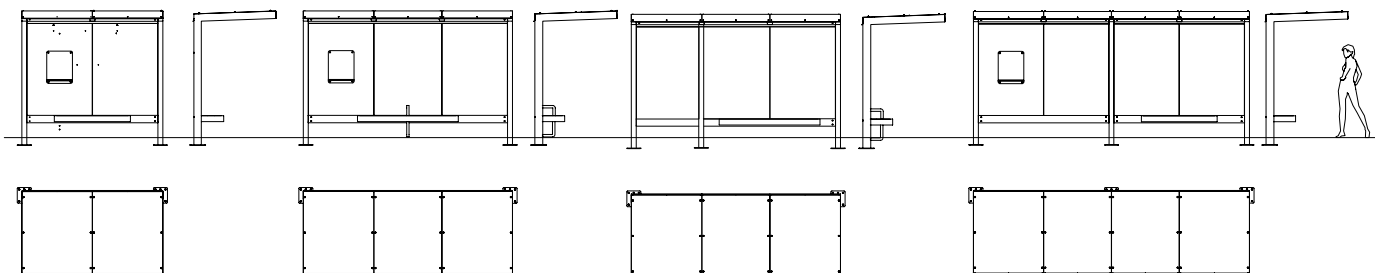

GARDA

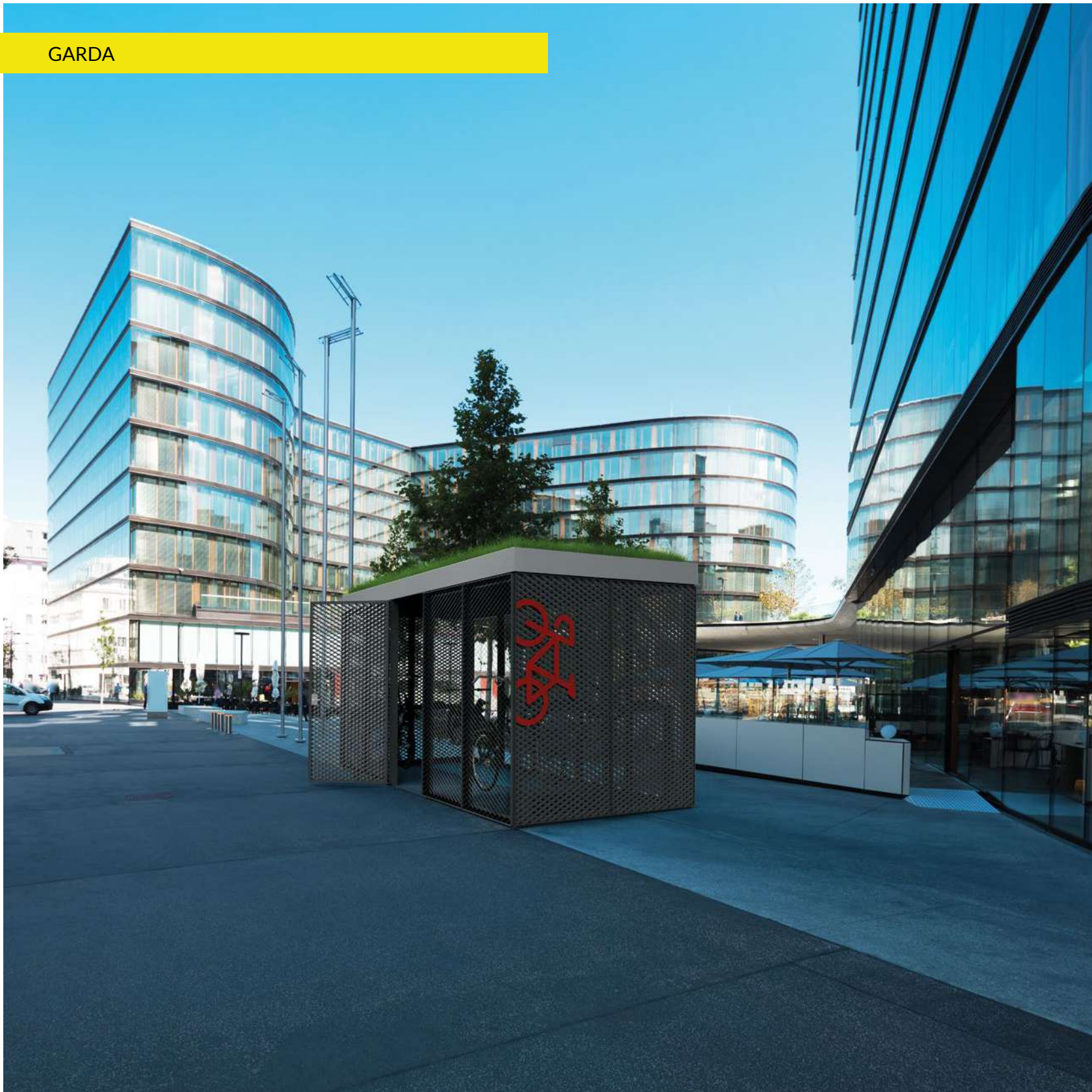





Collection of bike hub composed of steel tube structure and expanded metal sheet covering panels. The hub is equipped with a door, whose closure is protected by a customizable access control system. Two models are available: one with steel sheet roof, the other designed to accommodate a green system (not included). The structure is always equipped with LED lighting.

Colección de "box" para aparcar las bicicletas formadas por una estructura en tubo de acero y paneles de revestimiento de metal expandido. El "box" está equipado con una puerta, cuyo cierre está protegido por un sistema de control de acceso personalizable. Disponibles dos modelos: uno con una cobertura en chapa de acero, el otro diseñado para albergar una zona verde (no incluida). La estructura siempre está equipada con iluminación LED.

## GARDA

Designer:	Massimo Tasca
Dimensions/Dimensiones:	5285x2090 mm H 2755 mm
Materials/Materiales:	Powder coated steel Acero pintado
Fixing/Fijación:	Pre-drilled for anchors Predisposición para tacos

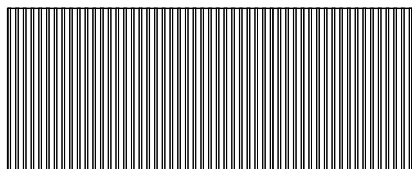
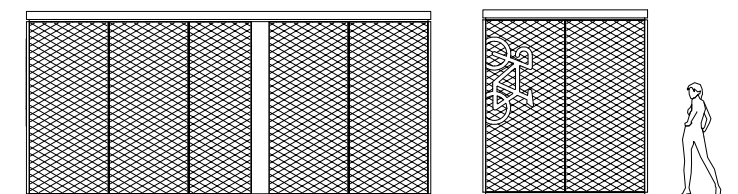

GPDUE







Collection of shelters composed of a steel load-bearing column, which supports a structure in the shape of an inverted pyramid. The latter is made of steel tube and covered below by sheets and wooden panels in Okumè plywood, protected by a waterproof sheath to convey rainwater inside the column through a special PVC pipe. The structure is designed to accommodate a LED lighting system. Models with different sizes and heights are available.

Colección de coberturas que pueden ser utilizadas como marquesinas, formadas por una columna portante en acero de la cual sale una estructura en forma de pirámide invertida. Esta última está realizada en tubo de acero y revestida internamente de chapas y en la parte superior de paneles multilaminas de madera Okume, protegidas por una funda impermeable para conducir las aguas pluviales por el interior de la columna a través de un tubo en PVC. La estructura está diseñada para poder equiparse con un sistema de iluminación LED. Disponibles modelos de diferentes tamaños y alturas.

## GPDUÉ

Designer: **Architetti Associati + Andrea Rinaldi + Roberta Casarini**

Dimensions/Dimensiones: **3500x2700 mm  
H 2660 mm (+150 mm)  
H 3080 mm (+150 mm)**

Materials/Materiales: **Powder coated steel  
Acero pintado**

Fixing/Fijación: **Plate with anchors  
Planchas con tirafondos**

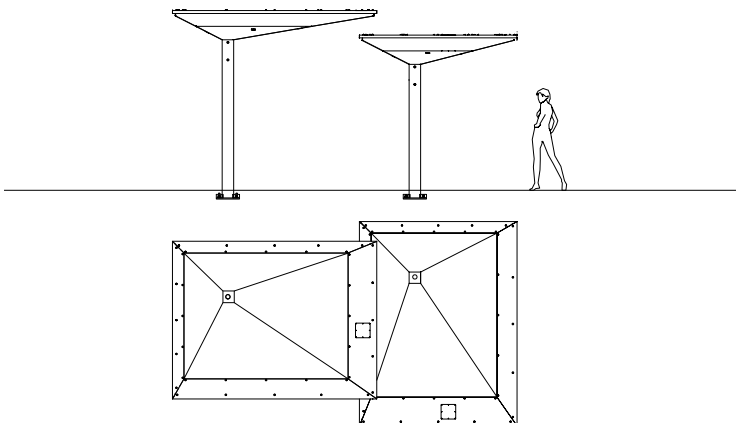

PENSILIS 1223







Shelter composed of load-bearing columns in steel profile and a monolithic frame, made of steel tube and profiles, that supports a roof made of tempered and coupled glass sheets, decorated with screen printing. The back walls are made of coupled glass and equipped with an advertising board made of aluminum profiles and equipped with lighting. The shelter is complete with toponym and it is provided with Sedis bench in Okumè wood, fixed to the lower current of the supporting structure. The glass sheets can be equipped with holes for the installation of an additional display board.

Marquesina formada por columnas portantes con perfiles en acero y por una estructura monolítica en tubo y perfiles de acero que soportan una cobertura compuesta por hojas de vidrio templado y acoplado, decoradas con serigrafías. Los cerramientos de fondo son en vidrio acoplado y equipado de un panel publicitario realizado en perfiles de aluminio y de iluminación. La marquesina dispone de topónimo y de un banco Sedis en madera Okume, fijada a la base de la estructura portante. Las hojas de vidrio pueden disponer de orificios para la instalación de otro expositor adicional.

## PENSILIS 1223

Designer:	Antonio Citterio con Toan Nguyen
Dimensions/Dimensiones:	L 4280x1223 mm   1353+2706 mm H 2383 mm L seat   asiento 2400 mm
Materials/Materiales:	Powder coated steel + Glass Acero pintado + Vidrio
Fixing/Fijación:	Plate with anchors Planchas con tirafondos

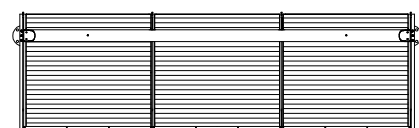
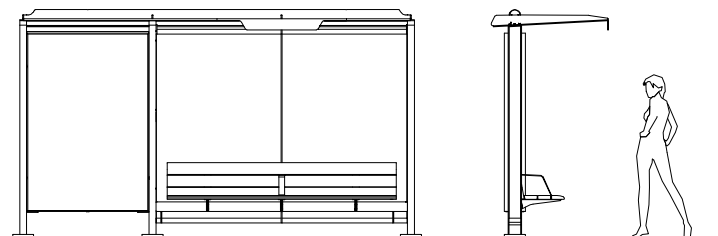

PENSILIS 1772

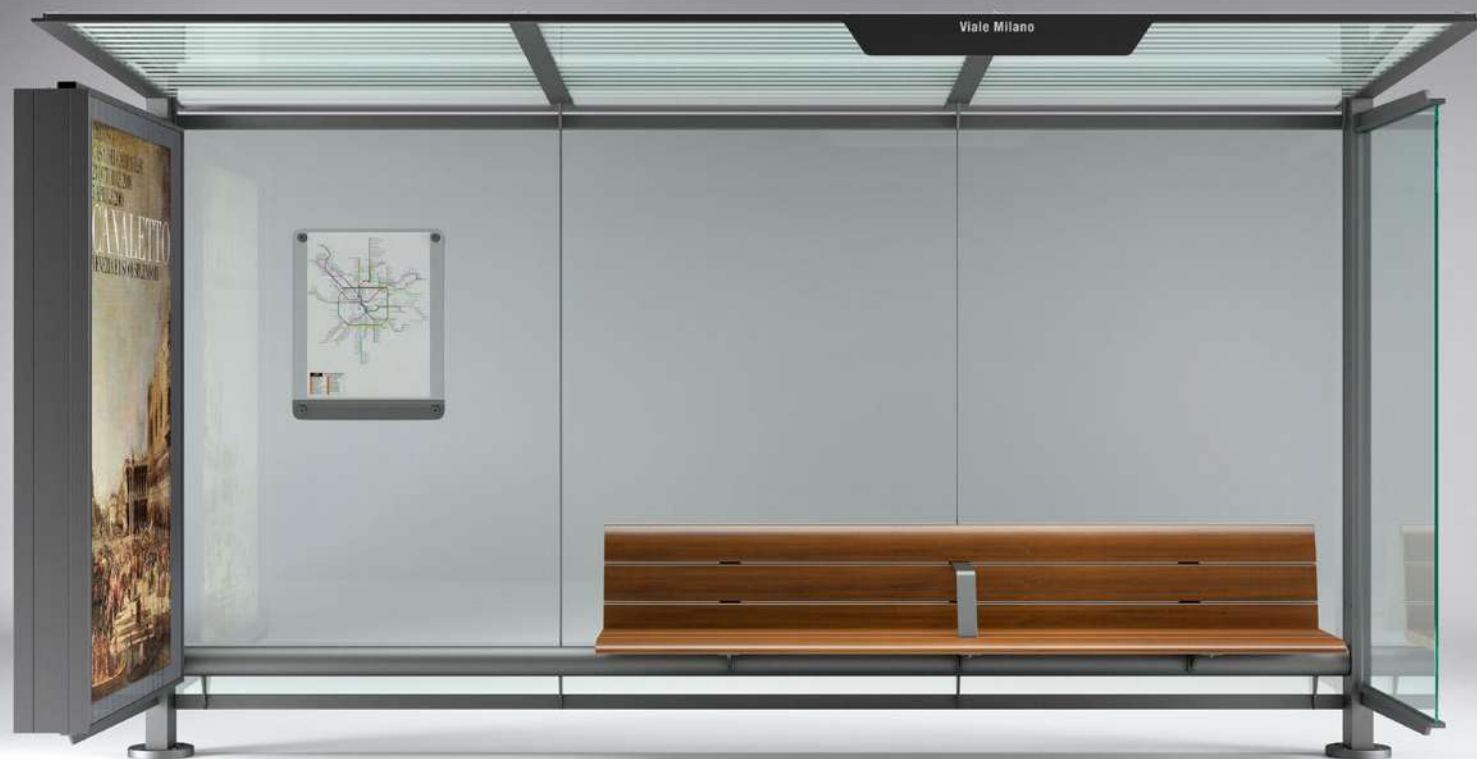





Shelter composed of load-bearing columns in steel profile and a monolithic frame, made of steel tube and profiles, that supports a roof made of tempered and coupled glass sheets, decorated with serigraphy. The back walls are made of coupled glass. The shelter is equipped with two side walls, one made of coupled glass and the other equipped with an advertising board made of aluminum profiles with integrated lighting system. The shelter is complete with toponym and it is provided with Sedis bench in Okumè wood, fixed to the lower current of the supporting structure. The glass sheets can be equipped with holes for the installation of an additional display board.

Marquesina formada por columnas portantes con perfiles en acero y por una estructura monolítica en tubo y perfiles de acero que soportan una cobertura compuesta por hojas de vidrio temperado y acoplado, decoradas con serigrafías. Los cerramientos de fondo son en vidrio acoplado. La marquesina dispone de dos cerramientos laterales, uno en vidrio acoplado y otro de un panel publicitario realizado en perfiles de aluminio y un sistema de iluminación integrado. La marquesina dispone de topónimo y de un banco Sedis en madera Okume, fijada a la base de la estructura. Las hojas de vidrio pueden disponer de orificios para la instalación de otro expositor adicional.

## PENSILIS 1722

Designer:	Antonio Citterio con Toan Nguyen
Dimensions/Dimensiones:	L 4292x1722 mm   4059 mm H 2383 mm L seat   asiento 2400 mm
Materials/Materiales:	Powder coated steel + Glass Acero pintado + Vidrio
Fixing/Fijación:	Plate with anchors Planchas con tirafondos

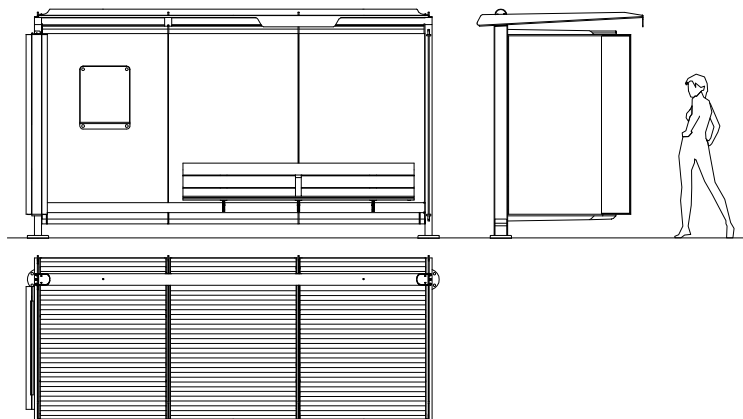



NORT











NORT

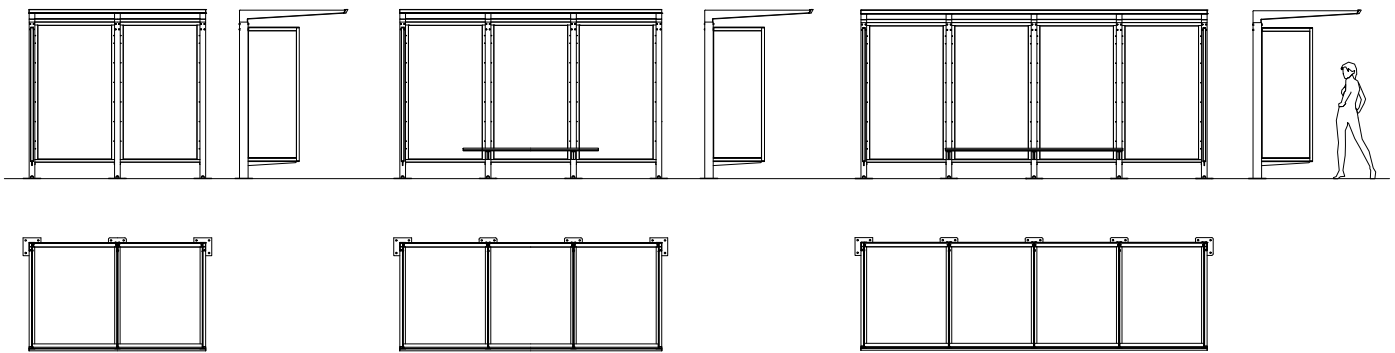





Modular shelter composed of load-bearing columns, a frame, both made of steel tube, and a back wall made of coupled glass sheets. The frame, equipped with a gutter to collect rainwater and convey it inside the columns, supports a roof in coupled and tempered glass sheets. The roof can accommodate a modular bench without backrest, with wooden seat, sustained by supports connected to the columns. It can be completed with glass side walls.

Marquesina modular formada por columnas portante, por una estructura, ambas en tubo de acero y por un cerramiento de fondo con hojas de vidrio acoplado. La estructura, provista de un canal para permitir el desagüe de las aguas pluviales, las transporta internamente en las columnas, que soportan una cubierta con hojas de vidrio acoplado y temperado. La marquesina puede equiparse con un banco modular sin respaldo, con asiento de madera, sostenido por soportes integrados a las columnas. Se puede completar con cerramientos laterales de vidrio.

## NORT

Designer:	Alfredo Tasca + Mattia Li Pomi
Dimensions/Dimensiones:	2 mod: 2480x1588 mm   1200 mm 3 mod: 3680x1588 mm   1200 mm 4 mod: 4880x1588 mm   1200 mm H 2378 mm
Materials/Materiales:	Powder coated steel Acero pintado
Fixing/Fijación:	Plate with anchors Planchas con tirafondos
Accessories/Accesorios:	Seat Asiento  Glass side walls Cerramientos laterales en vidrio

RIO









RIO

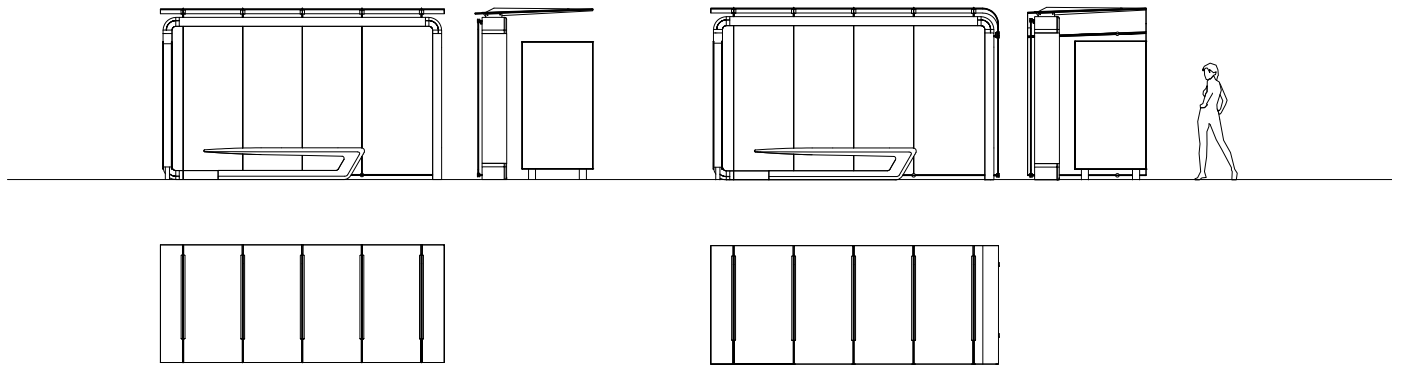





Collection of shelters composed of a load-bearing structure composed by an aluminium profile with an internal steel core and cast aluminium joints. In the upper part, the structure has a system of steel profiles that support a roof in coupled and tempered glass sheets and in the lower part an extension in HPC (High Performance Concrete) that serves as a cantilevered seat. The shelter is equipped with an autonomous side wall, composed of a steel frame with an integrated display board. Two versions are available, one of which has a side glass wall, with the same curvature of the roof.

Colección de marquesinas formadas por una estructura portante formada por un perfil de aluminio con núcleo interior en acero y juntas en fundición de aluminio. En la parte superior, la estructura cuenta con un sistema de perfiles de acero que soportan una cubierta de hojas de vidrio acoplado y temperado, en la parte inferior una extensión en HPC (High Performance Concrete) que actúa como asiento en voladizo. La marquesina está equipada con un cerramiento lateral autónomo, que consta de una estructura de acero con expositor integrado. Dos versiones disponibles, una de ellas con cerramiento lateral acristalado, con curvatura en continuidad de la cobertura.

## RIO

Designer:	Indio Da Costa AUDT
Dimensions/Dimensiones:	4025x1670 mm H 2430 mm 4060x1670 mm H 2430 mm
Materials/Materiales:	HPC (High Performance Concrete) + Powder coated aluminum + Powder coated steel HPC (High Performance Concrete) + Aluminio pintado + Acero pintado
Finishes/Acabados:	HPC Velluto - Liscio naturale HPC Velluto - Lisse naturel
Fixing/Fijación:	Plate with anchors Planchas con tirafondos
Accessories/Accesorios:	Information board Panel

UMBREL







Collection of shelters composed of one or two steel load-bearing columns, on which steel blades are radially welded, which can accommodate a LED lighting system. The steel blades support a roof made of a composite aluminum panel. The roof is inclined so as to convey rainwater inside the columns and it is equipped with an extruded aluminum perimetral closure, on which the toponym can be indicated. The shelter is equipped with a bench with backrest in elliptical steel profiles and a back and side frame, on which tempered glass sheets are anchored by stainless steel clamps.

Colección de marquesinas, formada por una o dos columnas portantes de acero, en el que las hojas de acero están soldadas radialmente, con posibilidad de iluminación LED, que soportan una cobertura formada por un panel de aluminio composite. La cobertura está inclinada para conducir el agua pluvial al interior de las columnas y está equipado con un perímetro de cierre en extrusión de aluminio, sobre el que es posible indicar el topónimo. La marquesina está equipada con un banco con asiento y respaldo en perfiles elípticos de acero y una estructura inferior y lateral sobre la que se fijan hojas de vidrio temperado mediante pinzas de acero inoxidable.

## UMBREL

Designer:	Mauro Saito
Dimensions/Dimensiones:	4800x1600 mm 3600x1600 mm H 2780 mm
Materials/Materiales:	Powder coated steel Acero pintado
Fixing/Fijación:	Installation with threaded bars Cimentación con varillas roscadas

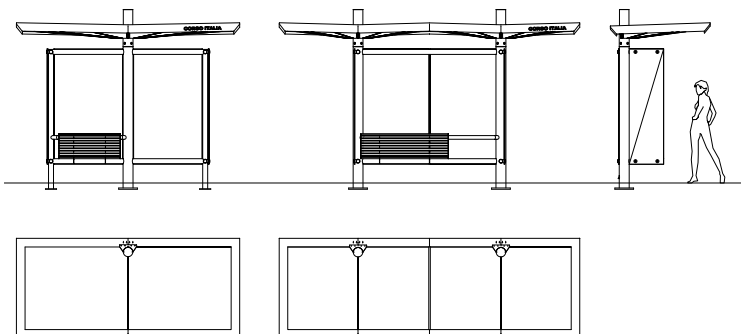

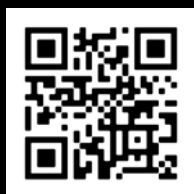



## SUSTAINABLE CHOICES

---

Behind every piece of street furniture there is the story of the materials composing it: the care with which we select them, and the techniques used to transform them. We love steel: we understand it intimately, and craft it with great care and passion. Right from the start, we have always believed in the power of colour. We have been the first to understand the potential of using Corten in street furniture and we have developed our own maturation process exploiting atmospheric agents by limiting the use of water, ensuring every single product unique and a one-off.

We choose wood from responsibly managed forests and treat it with the care that a living material deserves. Every day, we ask ourselves what solutions will be required in the future: we have enthusiastically embraced issues concerning sustainability, the incredible flexibility of WPC, and the elegant practicality of HPL. We have let ourselves be inspired by concrete, its expressive power and material nature. We get never tired of studying it, developing it, and making it perform better and in a more sustainable way.

## ELECCIONES SOSTENIBLES

---

Cada objeto de mobiliario urbano esconde una historia, la de sus materiales: la atención con la que se seleccionan, la técnica con la que se elaboran. Nos encanta el acero: lo conocemos a fondo, lo trabajamos con especial cuidado y pasión. Desde el principio, hemos creído en la fuerza del color. Hemos sido de los primeros en entender la potencialidad del Corten en el mobiliario urbano y hemos desarrollado un ciclo de maduración propio que, aprovecha los agentes atmosféricos, limitando el consumo de agua, lo que convierte cada producto en único e irreplicable.

Elegimos maderas de bosques gestionados de forma responsable y las tratamos con la atención que un material vivo requiere. Nos preguntamos todos los días cuáles podrían ser las soluciones del futuro: estamos encantados con la sostenibilidad y la increíble facilidad de WPC, así como con la elegante practicidad de HPL. Nos dejamos inspirar por el hormigón, por su fuerte expresividad y por la naturaleza del material. No nos cansamos de estudiarlo, de hacer que evolucione y hacerlo de la forma más eficaz y sostenible.

# POWDER COATED STEEL | POWDER COATED ALUMINUM

						
						
RAL						
						
						
						
SABLÉ						
						

The mentioned RAL and SABLÉ colours should be considered only illustrative.  
 Los colores RAL y SABLÉ que hemos mencionad deben considerarse sólo ilustrativos.



## POWDER COATED STEEL | POWDER COATED ALUMINUM

For every steel product and component, we choose the most suitable raw materials and treatments based on our production cycle and the needs of each design.

Our steel treatments include hot-dip galvanization, cold galvanizing, Sendzimir galvanization, cataphoresis and primer coating.

For our aluminum products and components, we use aluminum in sheet or in extrusion or in casting.

Then we powder coat steel, stainless steel, and aluminum with polyester powder, in accordance with EN ISO 12944-2.

We offer a wide range of standard RAL colors with wrinkled finish with different levels of texture. Only when customization through stickers, pad printing or serigraphy is provided, for technical reasons, their finish will be smooth matte or smooth glossy, depending on the technical feasibility.

We also offer the exclusive 'sable' colours, with a peculiar metallic wrinkled texture.

Upon request, different treatments and customizations are available, such as powder coating with non-standard RAL colors, and/or with smooth matte and smooth glossy finishes, and/or anti-graffiti treatment.

If required, the powder coating process of steel can be certified Qualisteelcoat.

## ACERO PINTADO | ALUMINIO PINTADO

Para cada uno de nuestros productos y componentes en acero, elegimos la materia prima y los tratamientos más idóneos en función de nuestro ciclo productivo y de las exigencias de cada uno de los diseños.

Nuestros tratamientos para el acero son: la galvanización en caliente y en frío, la galvanización Sendzimir, la cataforesis y el tratamiento "primer".

Para nuestros productos y componentes en aluminio, utilizamos láminas de aluminio, aluminio extruido o fundido.

Posteriormente, se recubre el acero, el acero inoxidable y el aluminio con pintura en polvo de poliéster, de acuerdo con lo dispuesto en la norma EN ISO 12944-2.

Ofrecemos una amplia gama de colores RAL estándar con acabado irregular y con diferentes niveles de gofrado, mientras que, solo donde se requiera la personalización con adhesivos, tampografía o serigrafía, por motivos técnicos, el acabado será liso (mate o brillante) según la viabilidad técnica.

También disponemos de colores exclusivos sable, con una particular textura irregular metalizada.

Bajo solicitud, disponemos de diferentes tratamientos y personalizaciones, incluyendo pinturas con colores no estándar, y/o con acabados lisos ya sea mate o brillante, y/o pintura anti-graffiti.

Bajo pedido, el ciclo de pintura de el acero puede ser certificado Qualsteelcoat.

STAINLESS STEEL | ACERO INOXIDABLE



BRUSHED | SATINADO

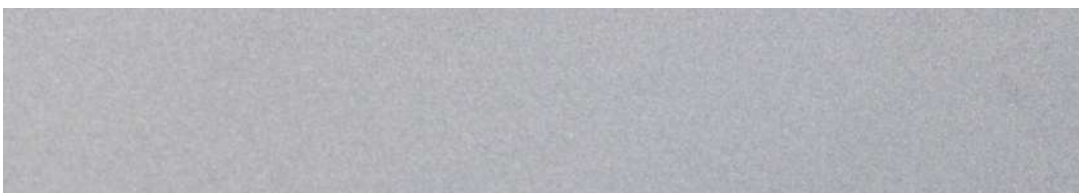

SHOTBLASTED | GRANALLADO



For our stainless steel products and components, we normally use AISI 304 or 304L stainless steel, but in case of installation in highly aggressive conditions we recommend requesting AISI 316 stainless steel.

Our stainless steel is usually brushed or shotblasted, depending on the technical features of the product.

Electropolishing treatment is also available, upon request.

Para nuestros productos y componentes en acero inoxidable, normalmente utilizamos acero AISI 304 o 304L. Sin embargo, aconsejamos, en el caso de que los productos vayan posicionados en lugares particularmente agresivos, de solicitar el acero AISI 316.

Por regla general, nuestro acero inoxidable es satinado o granallado, según las características técnicas del producto.

El tratamiento de electro-pulido está disponible previa solicitud.

A rectangular sample of Corten steel with a natural, weathered orange-brown patina. The text "CORTEN STEEL" is printed in a bold, dark font in the center.

**CORTEN STEEL**

OXIDIZED | OXIDADO

A rectangular sample of Corten steel with a wax finish, showing a smoother, more uniform reddish-brown color. The text "CORTEN STEEL + WAX" is printed in a bold, dark font in the center.

**CORTEN STEEL + WAX**

OXIDIZED PROTECTED WITH WAX | OXIDADO PROTEGIDO CON CERA

A rectangular sample of Corten steel with an anti-washout finish, appearing as a dark, almost black, smooth surface. The text "CORTEN STEEL + ANTI-WASHOUT" is printed in a bold, dark font in the center.

**CORTEN STEEL + ANTI-WASHOUT**

OXIDIZED PROTECTED WITH ANTIWASHOUT | OXIDADO PROTEGIDO CON ANTI-LAVADO



Corten steel is a "living" material, changeable over time, not uniform in appearance and each product has unique shades and colors.

We sandblast our products in Corten steel, before proceeding with the oxidation process, designed to limit water consumption.

To reduce physiological leak of oxide, upon request, wax protection treatment or antiwashout treatment are available.

In particularly saline environments, Corten steel may have a different reaction, we recommend evaluating the positioning.

El acero Corten es un material "vivo", que cambia con el tiempo, con una apariencia desigual, lo que hace que cada producto presente sombras y colores únicos.

Pulimos con un chorro de arena a todos nuestros productos en Corten, antes de continuar con nuestro proceso de oxidación, reduciendo así el consumo de agua.

Con el fin de reducir las pérdidas de óxido propias del material Corten, previa solicitud, están disponibles los tratamientos de protección con cera o con "olio antidilavamento" (aceite anti- lavado).

En ambientes particularmente salinos, el Corten puede comportarse de manera diferente, recomendamos, por tanto, evaluar la idoneidad del posicionamiento.



UNTREATED LARCH | ALERCE NATURAL

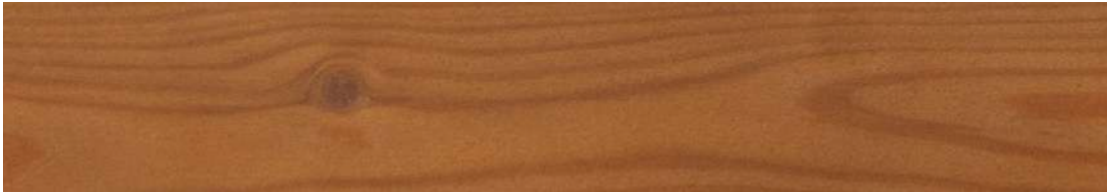

LARCH WITH PIGMENTED IMPREGNATION | ALERCE IMPREGNADO



VARNISHED OKUMÉ PLYWOOD | MULTILMINADO OKUMÉ BARNIZADO

For our hardwood and larch wood products we use a water-based pigmented impregnation treatment, but, if required by the client, wood can be left natural.

Okumé wood products are always supplied with water-based varnishing.

Larch wood we use is always FSC certified, for other wood essences this certification is on request.

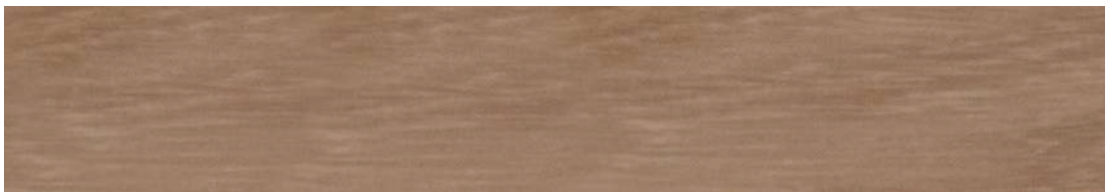

UNTREATED HARDWOOD | MADERA DURA NATURAL

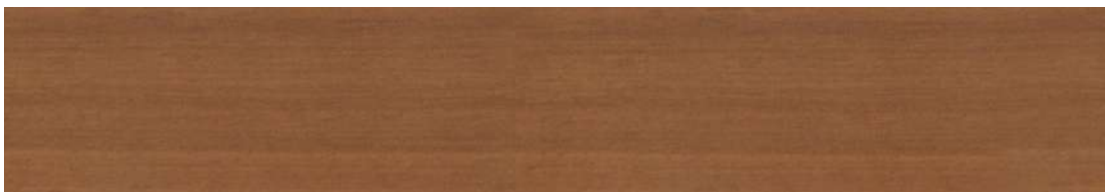

HARDWOOD WITH PIGMENTED IMPREGNATION | MADERA DURA IMPREGNADA



VARNISHED OKUMÉ | OKUMÉ BARNIZADO

Para nuestros productos en madera dura y alerce utilizamos un tratamiento consistente en una impregnación pigmentada a base de agua. Previa solicitud del cliente, la madera puede no tratarse y dejarse, por tanto, al natural.

Los productos en madera Okume, se tratan siempre con un barniz a base de agua.

El alerce que utilizamos esta siempre certificado FSC. Para las maderas, tales certificaciones deben solicitarse previamente.

NB: Tenga en cuenta que las imágenes reproducidas son meramente ilustrativas.  
Para obtener más información sobre los materiales, visite nuestro sitio web.



## WPC



### WPC PLUS



### WPC ULTRA

We selected two different types of WPC (Wood Polymer Composite) for our products, ULTRA and PLUS. They do not have to be considered as alternatives, because the choice depends on the technical features of each design.

Hemos seleccionado dos tipos de WPC (Wood Polymer Composite) para nuestros productos, ULTRA y PLUS; tipologías que no se deben considerar alternativas ya que la elección de uno u otra viene determinada por las características técnicas de cada diseño.

N.B.: Please note that the images reproduced on these pages are purely indicative.  
For more information about the materials, visit our website.



BLACK | NEGRO

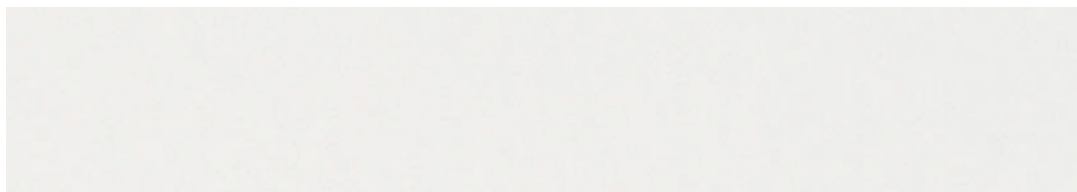

WHITE | BLANCO

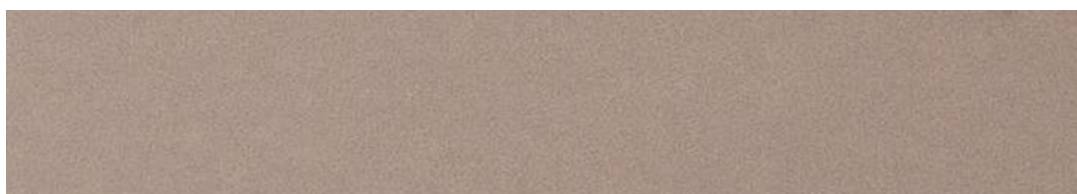

TAUPE | TÓRTOLA

We selected for our products HPL (High Pressure Laminate), that is a material particularly suitable for outdoor use and It is available in three different colors: white, black, and taupe.

El HPL (High Pressure Laminate) que hemos seleccionado para nuestros productos, es un material particularmente adaptado para el exterior y está disponible en uno de los tres colores siguientes: blanco, negro y tórtola.

NB: Tenga en cuenta que las imágenes reproducidas son meramente ilustrativas.  
Para obtener más información sobre los materiales, visite nuestro sitio web.

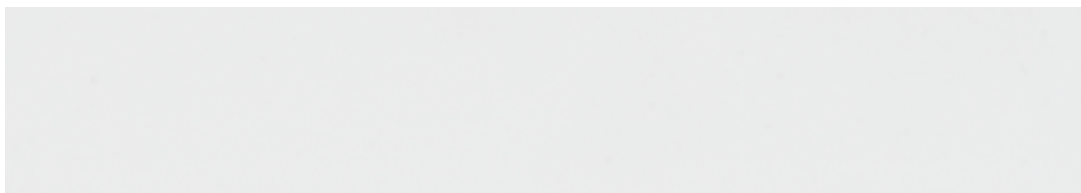

WHITE | BLANCO

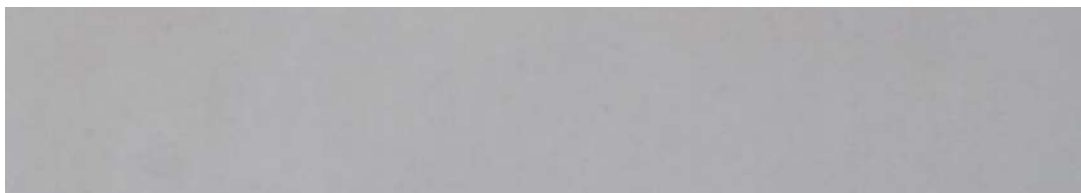

GREY | GRIS



DARK GREY | GRIS OSCURO



Our UHPC (Ultra High Performance Concrete) is available in three different colors, white, grey and dark grey, provided with ALFA - natural smooth finish.

Characterized by material appearance, UHPC can present not uniform cloudy effects of color and light cracks, which are physiological aspects of this material.

The finished products are treated with a protective varnish, and upon request, anti-graffiti treatment can also be applied.

Nuestro UHPC (Ultra High Performance Concrete) está disponible en tres colores blanco, gris y gris oscuro y el acabado es ALFA - liso natural.

Caracterizado por un aspecto material, el UHPC puede presentar un color que no es uniforme, así como ligeras grietas, en ambos casos se trata de aspectos fisiológicos de este tipo de material.

Una vez los productos están terminados se les aplica un barniz protector y previa solicitud, es posible aplicar el tratamiento anti-grafti.

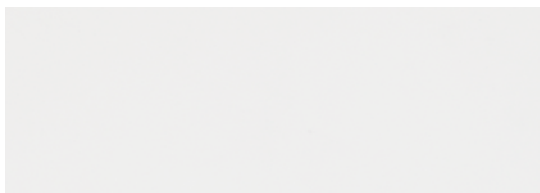

WHITE POLISHED | BLANCO PULIDO

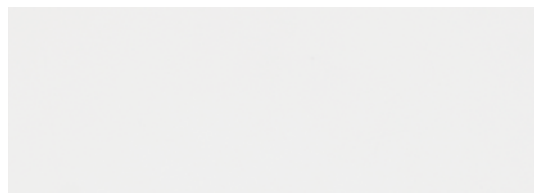

WHITE VELLUTO - NATURAL SMOOTH  
BLANCO VELLUTO - LISO NATURAL



GREY POLISHED | GRIS PULIDO

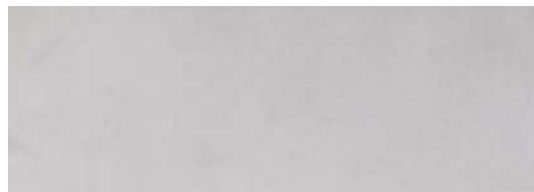

GREY VELLUTO - NATURAL SMOOTH  
GRIS VELLUTO - LISO NATURAL



DARK GREY POLISHED | GRIS OSCURO PULIDO



DARK GREY VELLUTO - NATURAL SMOOTH  
GRIS OSCURO VELLUTO - LISO NATURAL

Our HPC (High Performance Concrete) is available in three different colors, white, grey, and dark grey, and it is provided, as standard, with VELLUTO – natural smooth finish.

Characterized by material appearance, HPC can present not uniform cloudy effects of color and light cracks, which are physiological aspects of this material.

Upon request, when technically feasible, it is possible to perform polishing operations.

The finished products are treated with a protective varnish, and upon request, anti-graffiti treatment can also be applied.

Nuestro HPC (High Performance Concrete) está disponible en tres colores, blanco, gris y gris oscuro y el acabado es VELLUTO - liso natural.

Caracterizado por un aspecto material, el HPC puede presentar un color que no es uniforme, así como ligeras grietas, en ambos casos se trata de aspectos fisiológicos de este tipo de material.

Previa solicitud y siempre que técnicamente sea factible, es posible pulir en parte o totalmente el producto, para conseguir un acabado totalmente liso.

Una vez los productos están terminados se les aplica un barniz protector y previa solicitud, es posible aplicar el tratamiento anti-grafti.





WHITE GRANITE BRUSHED  
GRANITO BLANCO TRABAJADO CON PÚAS RÍGIDAS



WHITE GRANITE SANDBLASTED  
GRANITO BLANCO TRABAJADO CON CHORRO DE ARENA



GREY GRANITE BRUSHED  
GRANITO GRIS TRABAJADO CON PÚAS RÍGIDAS



GREY GRANITE SANDBLASTED  
GRANITO GRIS TRABAJADO CON CHORRO DE ARENA



WHITE MARBLE BRUSHED  
MÁRMOL BLANCO TRABAJADO CON PÚAS RÍGIDAS



WHITE MARBLE SANDBLASTED  
MÁRMOL BLANCO TRABAJADO CON CHORRO DE ARENA



BLACK MARBLE BRUSHED  
MÁRMOL NEGRO TRABAJADO CON PÚAS RÍGIDAS

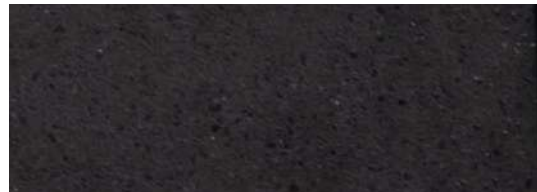

BLACK MARBLE POLISHED  
MÁRMOL NEGRO TRABAJADO CON CHORRO DE ARENA

Our PDM (Reconstituted Stones) is a mixture of concrete and aggregates that combines concrete resistance with natural stone elegance.

It is available in four options with white granite, with grey granite, with white marble, and with black marble.

Our products are normally provided with sandblasted finish and with brushed finish for the seating flat surfaces. Upon request, if the product allows it, it is possible to perform polishing operations. The finished products are treated with a revitalizing varnish and, if requested, anti-graffiti treatment can be applied.

Nuestro PDM (Piedras Reconstituidas) es una mezcla de cemento y áridos que combina la resistencia del hormigón y la elegancia de la piedra natural.

Está disponible en cuatro versiones: con granito blanco, con granito gris, con mármol blanco y con mármol negro.

Generalmente, en los productos en PDM, las superficies planas dedicadas para sentarse se fabrican con un pulido que llamamos "spazzolato" (acabado hecho con púas rígidas), mientras que el resto de las superficies tienen un acabado que llamamos "sabiato" (pulido con chorro de arena). Previa solicitud y siempre que técnicamente sea factible, es posible pulir en parte o totalmente el producto, para conseguir un acabado totalmente liso. Una vez los productos están terminados se les aplica un barniz protector y previa solicitud, es posible aplicar el tratamiento anti-grafti.





Street furniture plays a fundamental role, which is taking care of us so that we can enjoy the collective spaces, both indoor and outdoor. That is why we believe that each product deserves much attention. Our long experience has enabled us to hone the techniques and strategies required to produce all types of product: to find out more, we invite you to follow us on our website [www.metalco.it](http://www.metalco.it) and to discover the great dedication to details that goes into all our street furniture.

From periodic checks, to correct cleaning operations, right through to maintenance, we share our know-how with you, because every object of street furniture has a value that must be protected and respected.

El mobiliario urbano cumple un papel fundamental, cuidarnos para permitirnos vivir los espacios colectivos, interiores y exteriores. Es por ello, que creemos que cada producto debe, el también, recibir la atención adecuada. Nuestra dilatada experiencia nos permite identificar las técnicas y estrategias para cuidar cada tipo de producto: por ello te invitamos a seguirnos en nuestra página web [www.metalco.it](http://www.metalco.it) y descubrir todas esas pequeñas grandes atenciones que el mobiliario urbano requiere.

Desde los controles periódicos, pasando por las correctas operaciones de limpieza hasta el mantenimiento, compartimos con ustedes nuestro know-how porque cada objeto del mobiliario urbano tiene un valor que hay que proteger y respetar.



# The art of sociality

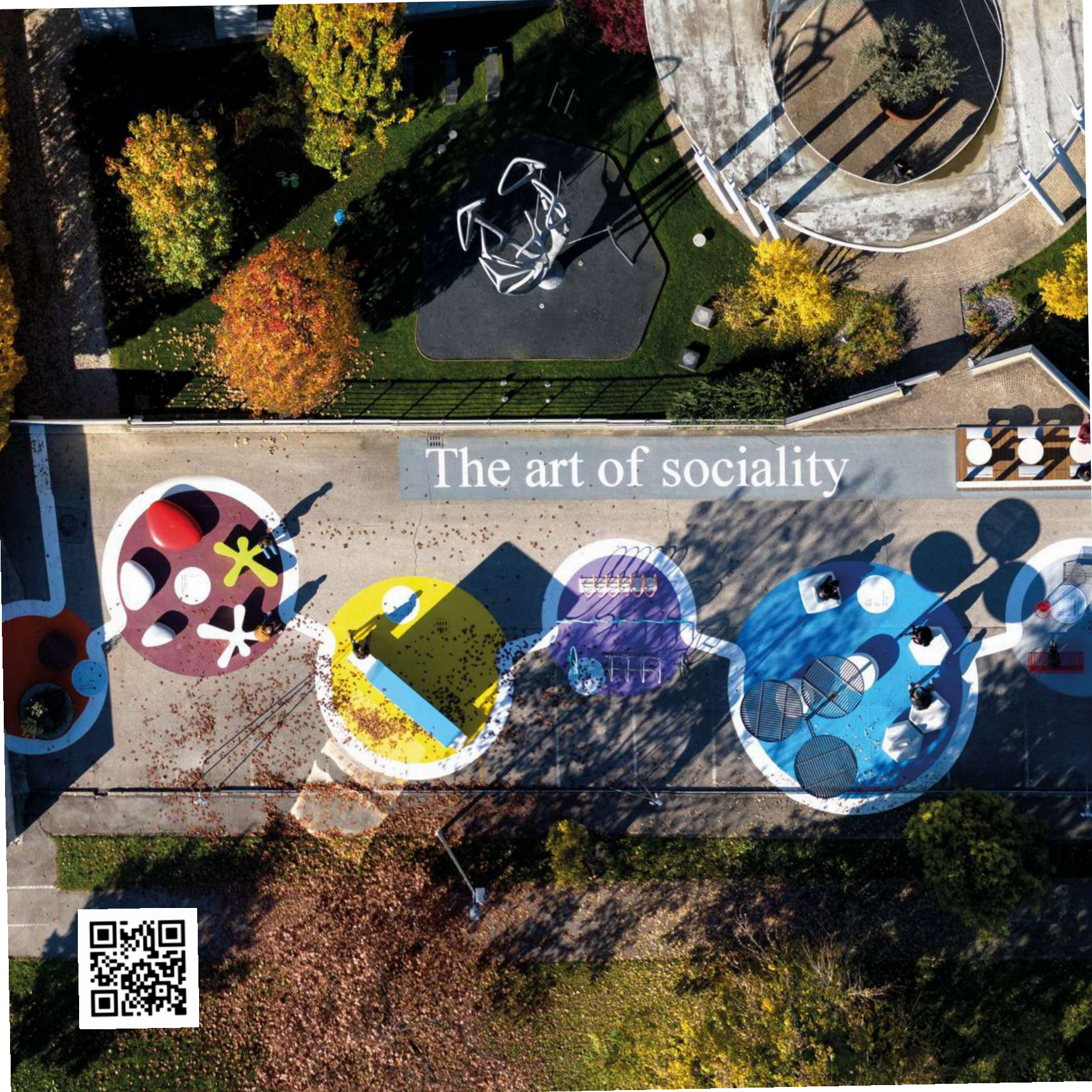



An aerial photograph of a park area. In the foreground, there are several large, colorful murals on the pavement. One is a large red circle with a white figure inside, another is a blue circle with a white figure, and a third is a green circle with a white figure. There are also some smaller murals and a bench. In the background, there is a circular structure with a brick base and a metal top, possibly a fountain or a playground feature. The word "METALCO" is visible on the top of this structure. The overall scene is bright and sunny, with shadows cast by the trees and structures.

We know that the creative energy that goes into sustainable urbanization cannot be compressed within the pages of a catalogue. That is why we think it is important to move beyond printed paper.

We are a company made up of resources, both tangible and virtual.

Stay in touch with us by visiting our website [www.metalco.it](http://www.metalco.it) and by following us on our social media channels to stay up to date, because creativity is an unstoppable process.

# LET'S FOLLOW THE "STILE"

## Sigue el *Stile*

Movements  
of  
STILE

Sabemos que toda la tensión creativa al servicio de la urbanización sostenible, no se puede comprimir en las páginas de un catálogo, por eso pensamos que es necesario ir más allá del papel impreso.

Somos una empresa formada por recursos, reales y virtuales, mantengámonos en contacto, visite nuestra página web [www.metalco.it](http://www.metalco.it) y síganos en las redes sociales para estar al día, porque la creatividad es un proceso que no se puede detener.



# AWARDS AND ACKNOWLEDGMENTS

## Premios y reconocimientos



2020  
Product: SMART SHELTER (BHLS TRANSOCEÁNICA STATIONS)  
Designed by: GUTO INDIO DA COSTA A.U.D.T.  
IF DESIGN AWARD 2020



2019  
Product: LA CABINEDDA BUS SHELTER  
Designed by: DAVIDE FANCELLO - STUDIO DI ARCHITETTURA  
GERMAN DESIGN AWARDS 2019



2019  
Product: EDGE BENCH  
Designed by: GUTO INDIO DA COSTA A.U.D.T.  
IF DESIGN AWARD 2019



2019  
Product: FORESTA BENCH  
Designed by: MASSIMO TASCA  
First Prize Good Design Awards



2020  
Product: ISOLAURBANA  
Designed by: MASSIMO TASCA  
Third place in the section "Young Designer" MDO PRIZE 2019



2020  
Product: RIO SMART SHELTER  
Designed by: GUTO INDIO DA COSTA A.U.D.T.  
First Prize in the section "Urban Design" MDO PRIZE 2019



2016  
Product: ULURU MODULAR BENCHES COLLECTION  
Designed by: ANDREA MORGANTE SHIRO STUDIO  
Muuz International Awards Winner 2016



2014  
Product: LIBRE BENCHES COLLECTION  
Designed by: ALFREDO TASCA  
Received a "SPECIAL MENTION" at the "GERMAN DESIGN AWARDS 2014"



2014  
Product: OSMOSE INTERACTIVE METRO STATIONS  
Designed by: MARC AUREL  
Received a "SPECIAL MENTION" at the "GERMAN DESIGN AWARDS 2014"



2013  
Product: OSMOSE INTERACTIVE METRO STATIONS  
Designed by: MARC AUREL  
Was awarded with the « Janus de la prospective »  
2013 by the Institut Français du design



2013  
Product: OSMOSE INTERACTIVE METRO STATIONS  
Designed by: MARC AUREL  
Product included in the ADI DESIGN INDEX



2013  
Product: LIBRE EVOLUTION BENCHES  
Designed by: ALFREDO TASCA  
Nominated for the "Prix du Palmarès de l'ArchiDesignClub"



2012  
Product: LOLA  
Designed by: LAGRANJA  
DELTA DE PLATA ADI-FAD 2012



2011  
Product: PALUS BOLLARD  
Designed by: ANTONIO CITTERIO  
XXI Edition of Premio Compasso D'Oro



2010  
Product: METALCO  
Award: "PREMI FESTIVAL CITTÀ IMPRESA 2010"



2010  
Product: LIBRE BENCH  
Designed by: ALFREDO TASCA  
included in the book "Disegno e Design Brevetti e creatività italiani"



2009  
Product: PALUS BOLLARD  
Designed by: ANTONIO CITTERIO with TOAN NGUYEN  
Product included in the ADI DESIGN INDEX



2008  
Product: SEDIS, SEDIS TORSION BENCHES  
Designed by: ANTONIO CITTERIO with TOAN NGUYEN  
XXI Edition of Premio Compasso D'Oro



2008  
Product: GHOST LITTER BIN  
Designed by: Raffaele Lazzari  
XXI Edition of Premio Compasso D'Oro



2007  
Product: SEDIS, SEDIS TORSION BENCHES  
Designed by: ANTONIO CITTERIO with TOAN NGUYEN  
Product included in the ADI DESIGN INDEX

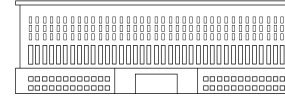

COLLEZIONE FARNESINA DESIGN

INCLUDED IN THE "COLLEZIONE FARNESINA DESIGN", TRAVELLING EXHIBITION, ROME AND WORLDWIDE:

Product: <b>VOLO BENCH</b>	
Designed by: <b>ALESSANDRO LENARDA</b>	
January 2010:	Casa Italia, XXII Winter Olympics Games, Vancouver
June 2010:	Casa Azzurri FIFA Word Cup, Pretoria
November 2010:	Culture European Capital, Istanbul
February-April 2011:	Holon National Museum, Tel Aviv
May-September 2011:	Ara Pacis Museum, Rome
November 2011:	Palais des Rais, Algeri
December 2011-January 2012:	Centre National d'Art Vivant, Tunis
February 2012:	Ecole Nationale d'Architecture, Rabat
July 2012:	"Ecosoluzioni/Design del quotidiano", Museum Musiikkitalo, Helsinki
July-August 2012:	"Queen Elizabeth II Conference Center", Olympics Games, London
October-November 2012:	"Ecosoluzioni/Design del quotidiano", Siovenian Museum, Lubjjan
October-November 2012:	Italian cultural Institute "Palazzo della Farnesina e le sue collezioni", Rome
	Exposed at Design Museum Holon, Tel Aviv (permanent exhibition)
	Exposed at Modern and Contemporary Art Gallery, Roma Capitale
October 2012-January 2013:	"Welcome to design-the best Made in Italy", Moscow



2005  
Product: GHOST LITTER BIN  
Designed by: RAFFAELE LAZZARI  
Product included in the ADI DESIGN INDEX



2004  
Product: LIBRE BENCH  
Designed by: ALFREDO TASCA  
Exposed at the exhibition "Disegno e Design. Brevetti e creatività italiani", Tongji University, Zhonghe Building, Shanghai



2004  
Product: GEA BENCH  
Designed by: STAUBACH + KUCKERTZ ARCHITEKTEN UND DESIGNER  
FIRST PRICE "CITTÀ DI ODERZO AZIENDA E DESIGN 2004"



2004  
Product: APOLLO BIKE RACK/BOLLARD  
Designed by: STAUBACH + KUCKERTZ ARCHITEKTEN UND DESIGNER  
Product included in the ADI DESIGN INDEX



2003  
Product: LUCKY BENCH  
Designed by: ALFREDO TASCA  
LE GRAND PRIX DU DESIGN URBAIN DE LA VILLE DE METZ 2003  
AWARDED AT THE 6TH EDITION OF THE SALON PROFESSIONNEL URBEST





Our company is present in the MEPA  
Electronic Market of Public Administration (ITALY) search through Metalco Srl  
or VAT number: IT04299810269

Nuestra empresa está presente en la MEPA  
Mercado Electrónico de la Administración Pública (ITALIA) (buscar a través de)  
Busque através Metalco Srl o número de identificación fiscal: IT04299810269

## ESNA-SOA

Società Organismo di Attestazione S.p.A.

OG9 classifica III - BIS  
OS24 classifica IV  
OS18 - A classifica III



The mark of  
responsible forestry



hEN 1090-1:2009+A1:2011



CONCEPT:  
Marina Tasca  
Metalco Marketing Dept.

PHOTOS | FOTO:  
urnato.it  
Marina Tasca  
Archivio Metalco | Metalco Archive

EXECUTIVE LAYOUT | DISEÑO EJECUTIVO:  
marigraf.it

PRINTING | PRENSA  
AGCM (PN)

© All rights reserved  
Reproduction of the contents (texts and images) of this  
publication, in whole or part is prohibited

© Derechos reservados  
Queda prohibida la reproducción total o parcial del contenido  
(textos e imágenes) de esta publicación

METALCO  
Via della Fornace, 44  
31023 Castelminio di Resana (TV) Italy

Printed in January 2021  
First Edition

Impreso en enero de 2021  
Primera edición

Metalco is certified: ISO 9001 (Quality Management System)  
and ISO 14001 (Environmental Management System).

Metalco está certificada: ISO 9001 (Sistema De Gestión De  
Calidad) y ISO 14001 (Sistema De Gestión Ambiental).

The purpose of this catalog is to provide general information  
about the products. The content of this document should not be  
considered either exhaustive or complete. The technical data,  
treatments, and materials described therein are in force at the  
date of printing. Photos, drawings, and texts are not contractual.  
Metalco reserves the right to delete and/or modify, and/or  
update, and/or supplement, and/or replace this catalog, and/  
or the materials and products contained therein, as well as the  
technology used.

Any significant changes will be reported on the Metalco website  
(metalco.it) and/or communicated via sales info or similar means.  
In any case, the most recently updated information material will  
be considered valid.

For any changes or updates refer to the website: metalco.it

El objetivo de este catálogo es proporcionar información general  
en relación con los productos, sin embargo el contenido de  
estos últimos no debe considerarse ni exhaustivo, ni completo.  
La información técnica, los tratamientos y los materiales aquí  
descritos, son los vigentes a la fecha de impresión del mismo. Las  
fotografías, dibujos y textos no tienen un valor contractual. Metalco  
se reserva el derecho de eliminar y / o modificar y / o actualizar  
y / o integrar y / o reemplazar este catálogo y / o los materiales  
y productos contenidos en el mismo, así como la tecnología  
utilizada. Cualquier cambio significativo se informará a través de  
la página web de Metalco (www.metalco.it) y / o se comunicará  
a través de una comunicación nominada "Sales Info" o mediante  
otros medios similares. En cualquier caso, se considerará válido el  
material informativo que haya sido actualizado más recientemente.

Para cualquier cambio o actualización, consulte el sitio web:  
metalco.it





Metalco S.r.l.

via della Fornace, 44  
31023  
Castelminio di Resana (TV) ITALY

T. +39 0423.7863  
F. +39 0423.786400

metalco.it  
info@metalco.it